

ISOLPACK®

SINCE
1951



CATALOGO TECNICO

Lamiere grecate
Sistemi grecati da solaio
Sistema Ampex
Scaffali cantilever

TECHINCAL CATALOG

Corrugated sheets
Corrugated slab system
Ampex System
Cantilever rack





L'edilizia si innova velocemente.

Isolpack, da oltre 70 anni, l'accompagna lungo una strada lunga, e grecata.

Isolpack S.p.A. nasce nel 1951 e per molti anni porta il nome **Ceria Lamiera Grecate**. È proprio la lamiera grecata il punto di partenza di questa azienda storica che, da oltre 70 anni, grazie ad una profonda esperienza nella profilatura a freddo, ne produce un'ampia serie di modelli destinati al mondo dell'edilizia.

La continua evoluzione del mercato ha portato ad uno scenario contemporaneo caratterizzato da bisogni assolutamente eterogenei, e a una richiesta di prodotti e servizi sempre più variegata, a cui **Isolpack** risponde con una vasta gamma di lamiere grecate versatili e dall'avanzato design, scelte da progettisti e costruttori italiani ed internazionali. Una proposta che spazia da singoli prodotti a sistemi articolati e modulari di elementi ed accessori adatti per le più svariate applicazioni in ambito edile, fino ai più importanti progetti "chiavi in mano" realizzati per prestigiosi studi di architettura e contractors.

Il servizio di consulenza tecnica segue il processo costruttivo in tutte le sue fasi, dalla progettazione sino all'installazione delle lamiere grecate, dalla scelta dei materiali e dei profili più idonei alla tipologia di costruzione fino alle indicazioni per una corretta gestione delle fasi di trasporto, stoccaggio e montaggio degli elementi.

Construction innovates quickly.

Isolpack, for over 70 years, has accompanied it along a long and corrugated road.

Isolpack S.p.A. was born in 1951 and for many years it was called **Ceria Lamiera Grecate**. The corrugated metal sheet is the starting point of this historic company which, for over 70 years, thanks to a deep experience in cold profiling, has been producing a wide range of models for the construction world. The continuous evolution of the market has led to a contemporary scenario characterized by absolutely heterogeneous needs, and to an increasingly varied demand for products and services, to which **Isolpack** responds with a wide range of versatile corrugated sheets with an advanced design, chosen by Italian and international designers and builders. A proposal that ranges from single products to articulated and modular systems of elements and accessories suitable for the most varied applications in the construction sector, up to important "turnkey" projects created for the most prestigious architectural firms and contractors.

The technical consultancy service follows the construction process in all its phases, from the design to the installation of the corrugated sheets, from the choice of the most suitable materials and profiles for the type of construction up to the indications for a correct management of the transport phases, storage and assembly of the elements.



L'aggiornamento costante della produzione, l'innovazione tecnica e la ricerca sui prodotti sono gli elementi essenziali che caratterizzano sin dal 1951 l'attività di **Isolpack**. Le lamiere grecate sono state sottoposte a numerose prove, aventi lo scopo di documentare, attraverso certificati, le prestazioni secondo standard riconosciuti a livello nazionale e internazionale. I risultati conseguiti sono il frutto di una continua ricerca finalizzata al miglioramento delle performances del prodotto. L'accurata scelta delle materie prime, gli avanzati processi di produzione, i numerosi controlli di qualità, in accordo con la normativa della **marcatatura CE**, sono garanzia di affidabilità e sicurezza.

*The constant production and technical innovation updating together with a constant product research are the essential elements that have characterized **Isolpack's** business since 1951. The corrugated sheets have been subjected to numerous tests, with the aim of documenting, through certificates, the performance according to nationally and internationally recognized standards. The results achieved are the result of continuous research aimed to improve the performance of the product. The careful selection of raw materials, the advanced production processes, the numerous quality controls, in accordance with the **CE marking** regulations, are a guarantee of reliability and safety.*



**SISTEMA QUALITÀ CERTIFICATO - QUALITY SYSTEM CERTIFIED
ISO 9001:2015 - ISO 14001:2015 - ISO 45001:2018**

CERTIFICATO



**Sistema di gestione ISO 9001:2015,
ISO 14001:2015 e ISO 45001:2018**

In base alla dimostrazione di conformità ai requisiti della norma suddetta, attestata in accordo con la procedura di certificazione, si dichiara che la società

Isolpack S.p.A.
C.so Vittorio Emanuele II, 99
I – 10128 Torino (TO)
con filiale (vedi allegato)

attuа un sistema di gestione per il seguente campo d'applicazione

Progettazione e produzione di pannelli in lamiera grecata semplice, autoportante e precoibentata con poliuretano o fibra minerale.

N° di registrazione del certificato:	TIC 15 100 1810383 TIC 15 104 211922 TIC 15 118 21499	Valido fino al: 2024-10-07 Valido da: 2021-11-19
Rapporto di audit n°:	3330 2V73 D0	

La presente certificazione è stata condotta in accordo alle procedure di certificazione e di auditing del TIC ed è soggetta a regolari audits di sorveglianza.

 TÜV Thüringen e.V.
 Organismo di certificazione di sistemi e del personale



Jena, 2021-11-19

I certified enterprise systems certified with TIC

Deutsche Akkreditierungsstelle
D-2M-16006-05-01
D-2M-16006-05-03
D-2M-16006-05-04

La validità dei certificati può essere verificata sulla pagina internet: www.tuv-thueringen.de
 Zertifizierungsstelle des TÜV Thüringen e.V. • Erntedankring 9 • D-07745 Jena • ☎ +49 3641 259740 • ✉ anfrage@tuv-thueringen.de

CERTIFICATO DI CONFORMITÀ DEL CONTROLLO DELLA PRODUZIONE IN FABBRICA EN 1090
CONFORMITY OF FACTORY PRODUCTION CONTROL EN 1090



CERTIFICATO DI CONFORMITÀ DEL CONTROLLO DELLA PRODUZIONE IN FABBRICA

Certificato numero **1370-CPR-1196**

In conformità al Regolamento 305/2011/EU del Parlamento Europeo e del Consiglio del 9 marzo 2011 (Regolamento Prodotti da Costruzione - CPR), questo certificato si applica al prodotto da costruzione:

PRODOTTO	ELEMENTI STRUTTURALI IN ACCIAIO NON SALDATI
SPECIFICHE	Classe di Esecuzione: fino a EXC 4 inclusa Metodi di marcatura CE: 3a

immesso sul mercato con il nome o il marchio di:

FABBRICANTE	ISOLPACK S.p.A. SEDE LEGALE: Corso Vittorio Emanuele II, 99 - 10128 TORINO (TO)
--------------------	--

e fabbricato nello stabilimento di produzione di:

STABILIMENTO DI PRODUZIONE	Via Nino Bixio, 64 - 10042 NICHELINO (TO)
-----------------------------------	---

Questo certificato attesta che tutte le disposizioni riguardanti la valutazione e la verifica della costanza della prestazione descritte nell'Allegato ZA della norma armonizzata:

EN 1090-1:2009 + A1:2011 - Esecuzione di strutture di acciaio e alluminio

nell'ambito del sistema AVCP 2+ sono applicate e che il controllo della produzione in fabbrica soddisfa tutti i requisiti applicabili.

Questo certificato è stato emesso la prima volta il **06-09-2016** e rimane valido fino a che la norma armonizzata, il prodotto da costruzione, il metodo AVCP e le condizioni di produzione nello stabilimento non sono modificati significativamente, a meno che non risulti sospeso o ritirato dall'organismo notificato per la certificazione del controllo della produzione in fabbrica.

Milano, il 06-09-2016
Rev. 0



Il Direttore Tecnico
Ing. Francesco SUTTERA

Bureau Veritas Italia S.p.A - Organismo Notificato n° 1370
Via Miramare, 15 - 20126 Milano - ITALIA

Pag 1 di 1



CERTIFICATE OF CONFORMITY OF THE FACTORY PRODUCTION CONTROL

Certificate number **1370-CPR-1196**

In accordance with Regulation 305/2011/EU of the European Parliament and of the Council of 9 March 2011 (Construction Products Regulation - CPR), this certificate applies to the construction product:

PRODUCTS	NOT WELDED STRUCTURAL COMPONENTS FOR STEEL STRUCTURES
CHARACTERISTICS	Execution Class: up to EXC 4 included CE Marking Method: 3a

placed on the market under the name or trade mark of:

MANUFACTURER	ISOLPACK S.p.A. HEAD OFFICE: Corso Vittorio Emanuele II, 99 - 10128 TORINO (TO) - ITALY
---------------------	--

and produced in the manufacturing plant:

MANUFACTURING PLANT	Via Nino Bixio, 64 - 10042 NICHELINO (TO) - ITALY
----------------------------	---

This certificate attests that all provisions concerning the assessment and verification of constancy of performance described in Annex ZA of the standard:

EN 1090-1:2009 + A1:2011 - Execution of steel and aluminium structures

under system 2+ are applied and that the factory production control is assessed to be in conformity with the applicable requirements.

This certificate was first issued on **06-09-2016** and will remain valid as long as neither the harmonised standard, the construction product, the AVCP methods nor the manufacturing conditions in the plant are modified significantly, unless suspended or withdrawn by the notified factory production control certification body.

**Technical specification for welding joints in Annex 1/1*

Milan, 06-09-2016
Rev. 0



Technical Director
Eng. Francesco SUTTERA

Bureau Veritas Italia S.p.A - Notified Body n° 1370
Via Miramare, 15 - 20126 Milan - ITALIA

Page 1 of 1

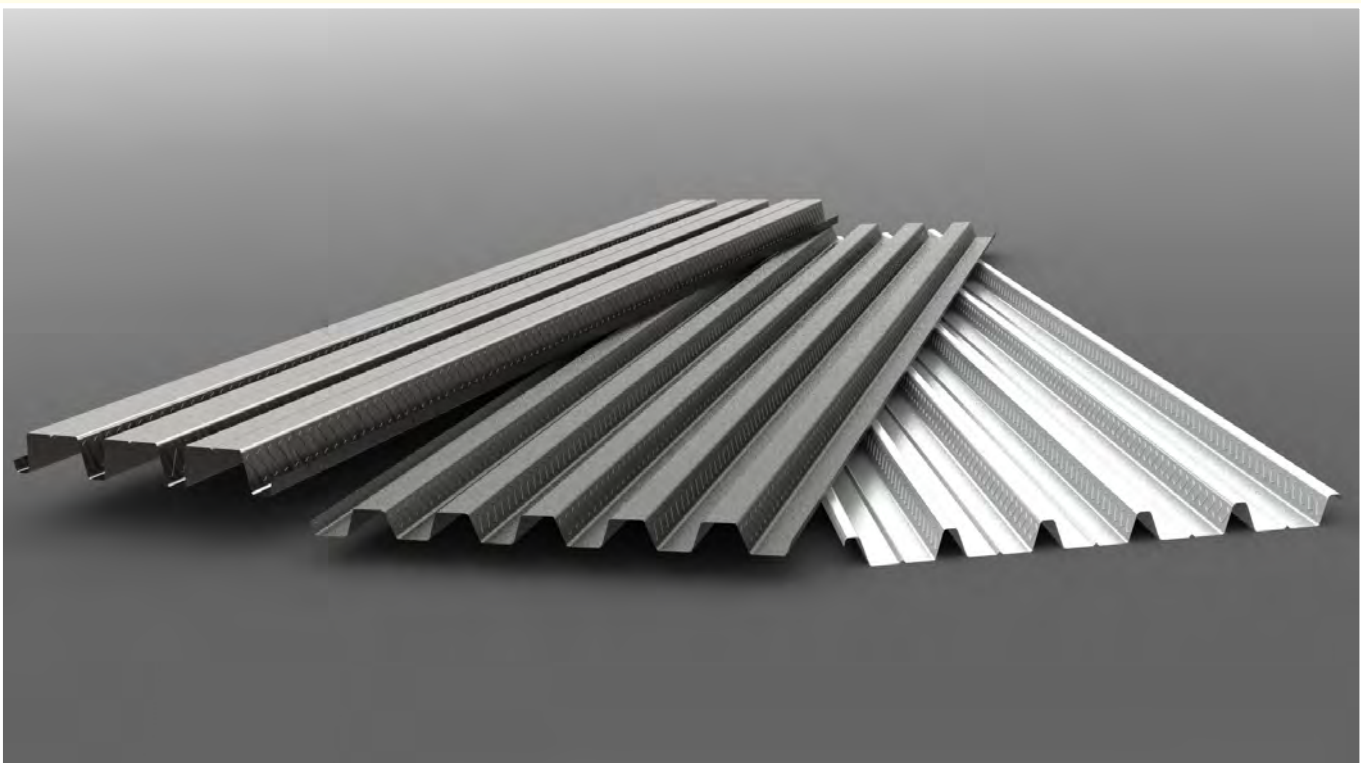



L'azienda / <i>the company</i>	pag.3
Certificati / <i>certifications</i>	pag.4
Guida alla consultazione / <i>consultation guidelines</i>	pag.8
LAMIERE GRECATE / CORRUGATED SHEETS	pag.11
E/P 3000 - Parete - soffittatura / <i>wall - ceiling</i>	pag.12
MODUL 25 - Parete / <i>wall</i>	pag.14
ONDUL 18 - Copertura - parete / <i>roof - wall</i>	pag.16
H20 - Copertura - parete / <i>roof - wall</i>	pag.18
SL940 - Copertura - parete / <i>roof - wall</i>	pag.20
H28 - Copertura - parete / <i>roof - wall</i>	pag.22
EUROSILMA - Copertura / <i>roof</i>	pag.24
SILMA 6 - Copertura / <i>roof</i>	pag.26
SILMA 8 - Copertura / <i>roof</i>	pag.28
CT/C 200 - Copertura / <i>roof</i>	pag.30
LG 40/1000 G5 - Copertura / <i>roof</i>	pag.32
R/W 1000 - Copertura / <i>roof</i>	pag.34
Applicazioni - curvatura / <i>applications - bending</i>	pag.36
Applicazioni - sormonto e appoggio / <i>application - overlap and support</i>	pag.40
True color system - colori / <i>colours</i>	pag.43
Accessori disponibili / <i>Accessories</i>	pag.44
DRYTEC	pag.47
Applicazioni DRYTEC / <i>DRYTEC applications</i>	pag.50
LAMIERE DA SOLAIO / SLAB CORRUGATED SHEETS	pag.53
S/C 2000 DECK - Lamiera da solaio / <i>slab corrugated sheet</i>	pag.54
S/C 2000 - Lamiera da solaio / <i>slab corrugated sheet</i>	pag.58
R/C 400 - Lamiera da solaio / <i>slab corrugated sheet</i>	pag.62
E/S 4000 - Lamiera da solaio / <i>slab corrugated sheet</i>	pag.66
LG 55 600/750 - Lamiera da solaio / <i>slab corrugated sheet</i>	pag.70
LG 75 - Lamiera da solaio / <i>slab corrugated sheet</i>	pag.74
TECNODEC 105 - Lamiera da solaio / <i>slab corrugated sheet</i>	pag.78
TECNODEC 150 - Lamiera da solaio / <i>slab corrugated sheet</i>	pag.82
LAMIERE DA SOLAIO CLS AM / CONCRETE SLAB CORRUGATED SHEETS	pag.87
E/S 4000 AM - Lamiera da solaio CLS AM / <i>concrete slab corrugated sheet</i>	pag.88
S/C 2000 AM - Lamiera da solaio CLS AM / <i>concrete slab corrugated sheet</i>	pag.92
R/C 400 AM - Lamiera da solaio CLS AM / <i>concrete slab corrugated sheet</i>	pag.96
SISTEMA AMPEX / AMPEX SYSTEM	pag.101
Criteri di progettazione e spezzonatura / <i>design and segmenting criteria</i>	pag.104
Sistema Ampex - tabelle di portata / <i>Ampex system load table</i>	pag.106
ISOSTOCK - SCAFFALATURA CANTILEVER / CANTILEVER RACK	pag.125
Isostock - tabelle di portata / <i>load table</i>	pag.130

COME SI LEGGONO I DISEGNI - HOW TO READ THE DRAWINGS

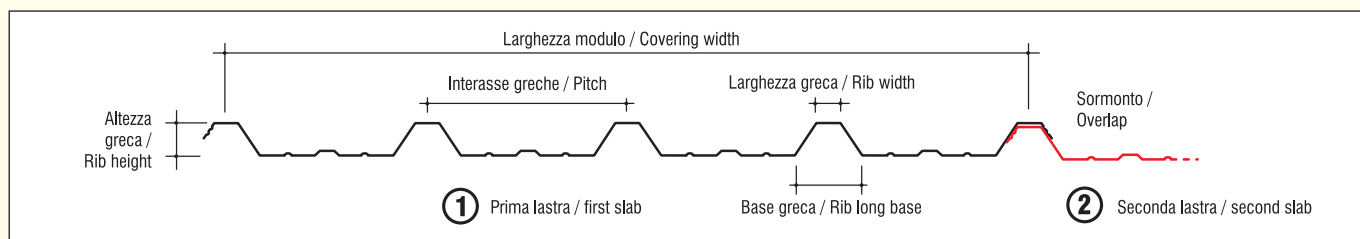

Interasse greche = distanza tra il centro di una greca e il centro della greca successiva;

Larghezza modulo = larghezza effettiva coperta, al netto dei sormonti;

Altezza greca = distanza massima tra la base inferiore della lamiera ed il punto più alto della greca.

Pitch = distance between the center of a corrugation and the center of the next corrugation;

Covering width = effective covered width, net of overlaps;

Rib height = maximum distance between the lower base of the metal sheet and the highest point of the rib.

TABELLE DI PORTATA PUBBLICATE - PUBLISHED LOAD TABLE

I rapporti di prova pubblicati in questo catalogo vengono forniti a titolo puramente indicativo.

I dati pubblicati sono stati calcolati secondo le Norme vigenti: NTC2018, Circolare esplicativa alle NTC2018, UNI EN 1993 (EC3). **Per una corretta applicazione del prodotto sarà onere e cura del cliente e/o del progettista la redazione di calcoli appropriati con specifico riferimento al singolo impiego.** Gli spessori e la qualità di acciaio indicati non rappresentano uno standard di prodotto, poichè la combinazione di spessori e materiali viene determinata in base alle esigenze tecniche di clienti e progettisti, che sono pertanto tenuti a specificare spessore, qualità e tipo di materiali che il produttore dovrà impiegare per la profilatura delle lamiere grecate.

Sul presente catalogo le tabelle sono composte da più settori, ciascuno relativo a uno schema statico: da una, fino a quattro campate (per campate multiple con numero di luci maggiore di 4, si può fare comunque riferimento allo schema a 4 campate).

Per ciascun settore, le colonne sono relative a determinate luci di calcolo (L), mentre le righe mostrano i diversi spessori (S) della lamiera. Per ogni luce e spessore, le tabelle riportano due valori di carico massimo uniformemente distribuito: in blu è indicato il carico ammissibile distribuito per la condizione di Stato Limite Ultimo (SLU) della lamiera (senza limitazione di freccia), in giallo il carico ammissibile distribuito per la condizione di Stato Limite di Esercizio (SLE) della lamiera.

The test reports published in this catalogue are provided for indicative purposes only.

The published data have been calculated according to the regulations in force: NTC2018, Explanatory Circular to NTC2018, UNI EN 1993 (EC3). **For a correct application of the product it will be the responsibility and care of the customer and/or the designer to prepare appropriate calculations with specific reference to the single use.** The thicknesses and quality of steel indicated do not represent a product standard as the combination of thicknesses and materials is determined by the customer based on their technical needs, therefore the customer and/or designer are required to specify thickness, quality and type of materials that the manufacturer will have to use for profiling the ribs.

In this catalog, the tables are made up of several sectors, each relating to a static scheme: from one, up to four spans (for multiple spans with a number of spans greater than 4, however, reference can be made to the 4 span scheme). For each sector, the columns relate to certain calculation spans (L) while the rows relate to certain thicknesses (S) of the metal sheet. For each span and for each thickness, the tables show two values of uniformly distributed maximum load: in blue there is the admissible load distributed for the Ultimate Limit State (ULS) condition of the sheet (without deflection limitation), in yellow there is the permissible load distributed for the Working Limit State (WLS) condition of the sheet.

DATA PUBBLICAZIONE APRILE 2022 - PUBLICATION DATE APRIL 2022

ELENCO NORMATIVE VIGENTI RELATIVE AL CAMPO DI APPLICAZIONE LAMIERE GRECATE E LAMIERE STRUTTURALI <i>LIST OF CURRENT REGULATIONS RELATING TO THE FIELD OF APPLICATION OF CORRUGATED METAL SHEETS AND STRUCTURAL METAL SHEETS</i>		
NORMA <i>NORM</i>	DESCRIZIONE <i>DESCRIPTION</i>	APPLICAZIONE <i>APPLICATION</i>
EN 14782	Lastre metalliche autoportanti per coperture, rivestimenti esterni e interni <i>Self-supporting metal sheets for roofing, external and internal cladding</i>	Lamiere grecate <i>Corrugated metal sheets</i>
EN 13501	Classificazione al fuoco dei prodotti e degli elementi da costruzione <i>Fire classification of products and building elements</i>	
EN 10088 1-2-3	Acciai inossidabili <i>Stainless steels</i>	
EN 506	Prodotti di lastre metalliche per coperture - Specifiche per prodotti autoportanti di lastre di rame o zinco <i>Roofing Metal Sheet Products - Specification for self-supporting copper or zinc sheet products</i>	
EN 485 1-2-3-4	Alluminio e leghe di alluminio - Lamiere, nastri e piastre <i>Aluminum and aluminum alloys - Sheet metal, strip and plate</i>	
EN 10346	Prodotti piani di acciaio rivestiti per immersione a caldo in continuo per formatura a freddo <i>Flat steel products coated by continuous hot dipping for cold forming</i>	Lamiere grecate e elementi strutturali <i>Corrugated metal sheets and structural elements</i>
EN 508 1-2-3	Prodotti di lastre metalliche per coperture e rivestimenti - Specifiche per prodotti autoportanti in lastre di acciaio, alluminio o acciaio inossidabile <i>Metal Sheet Products for Roofing and Cladding - Specification for Self-Supporting Steel, Aluminum or Stainless Steel Sheet Products</i>	
EN 10143	Lamiere sottili e nastri di acciaio con rivestimento applicato per immersione a caldo in continuo - Tolleranze sulla dimensione e sulla forma <i>Thin sheets and steel strips with coating applied by continuous hot dipping - Tolerances on size and shape</i>	
EN 10169	Prodotti piani di acciaio rivestiti in continuo con materiale organico (nastri rivestiti) <i>Flat steel products continuously coated with organic material (coated tapes)</i>	
EN 10204	Prodotti metallici - Tipi di documenti di controllo <i>Metallic Products - Types of Control Documents</i>	
EN 10025 1-2	Prodotti laminati a caldo di acciai per impieghi strutturali <i>Hot rolled products of structural steels</i>	
EN 13523	Nastri metallici rivestiti <i>Coated metal tapes</i>	
EN 10051	Nastri laminati a caldo in continuo, lamiere e fogli tagliati da nastri, non legati e legati <i>Continuous hot rolled strips, plates and sheets cut from strips, unbound and bound</i>	Lamiere strutturali <i>Structural metal sheets</i>
EN 1090 -1	Esecuzione di strutture di acciaio e di alluminio <i>Execution of steel and aluminum structures</i>	



Si consideri che, come regola di massima, una maggiore altezza delle greche garantisce una maggiore portata, mentre le altezze inferiori delle lamiere autocentranti si adattano senza lavorazioni aggiuntive a superfici di appoggio curve.

Tutte le lamiere grecate possono essere ordinate scegliendo tra un'ampia gamma di colori e finiture, e prevedono la possibilità di perfezionare le prestazioni tramite l'applicazione di guaine o tessuti antirumore e/o anticondensa. E' inoltre disponibile un'ampia gamma di accessori a completamento del sistema (materiali isolanti, pressopiegati e profili ad omega per sottostrutture, sistemi di fissaggio, guarnizioni, elementi traslucidi, ecc.).

Is considered that, as a general rule, a greater height of the ribs guarantees a greater load capacity, the lower heights of the self-balancing sheets, on the other hand, adapt to curved support surfaces without additional processing.

All corrugated sheets can be ordered by choosing from a wide range of colors and finishes, and provide the possibility of improving performance by applying sheaths or anti-noise and/or anti-condensation fabrics. A wide range of accessories is also available to complete the system (insulating materials, press-bent and omega profiles for substructures, fastening systems, gaskets, translucent elements, etc.).

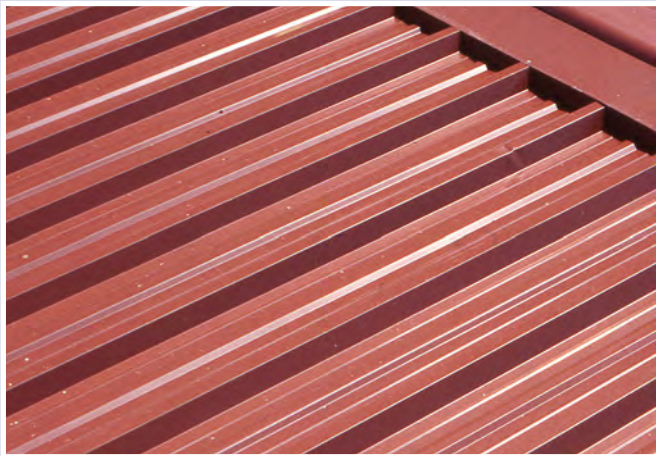

MODELLO MODEL	APPLICAZIONI - APPLICATIONS			
	Parete Wall	Copertura Roof	Soffittatura Ceiling	Copertura Piana Deck Roof
E/P 3000	✓			
MODUL 25	✓			
ONDUL 18	✓	✓		
H20	✓	✓		
SL 940	✓	✓		
H28	✓	✓		
H28 SVM	✓	✓		
EUROSILMA		✓		
SILMA 6		✓		
SILMA 8		✓		
CT/C 200		✓		
LG 40		✓		
R/W1000		✓	✓	
R/W1000 ALU		✓	✓	
S/C 2000 DECK (vd pag. / see page 54)			✓	✓
S/C 2000 (vd pag. / see page 58)		✓		
S/C 2000 ALU (vd pag. / see page 58)		✓	✓	
R/C 400 (vd pag. / see page 62)				✓
E/S 4000 (vd pag. / see page 66)			✓	✓



Elemento plurifunzionale, impiegato sia in parete sia in soffittatura (interna). La resa migliore dal punto di vista estetico la si ottiene in facciata, dove la sua caratteristica greca dal basso profilo è ideale complemento per il rinnovamento e la realizzazione di edifici industriali.

Multifunctional element, used both for wall and ceiling (internal). The best result from an aesthetic point of view is obtained on the façade, where its ribbed shape characterized with a low profile is an ideal complement for the renovation and construction of industrial buildings.

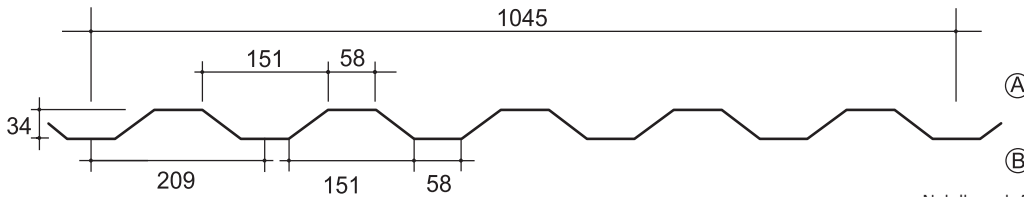
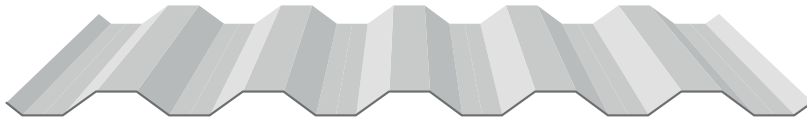

Tipo di sormonto
Overlap Type

Nei disegni, A o B indicano il lato preverniciato desiderato.
In the drawings A or B show the wished prepainted side.

Nome del prodotto Product name	Numero greche Number of ribs (nr)	Interasse greche Pitch (mm)	Altezza greca Rib height (mm)	Larghezza greca Rib width (mm)	Base greca Rib long base (mm)	Larghezza modulo Covering width (mm)	Numero greche di sormonto Rib overlap (nr)
E/P 3000	5/6	209	34	58	151	1045	1

COMPORTAMENTO AL FUOCO / FIRE REACTION	
Reazione al fuoco / Fire reaction class	A1 - UNI EN 13501-1
Comportamento al fuoco dall'esterno / External fire performance	Broof - UNI EN 13501-5 - CWFT - UNI ENV 1187

Caratteristiche tecniche - Datasheet

Dimensioni: larghezza 1045 (mm), lunghezza a richiesta da produzione in continuo.

Spessori: fino a mm 0,8 - anche non standard su richiesta.

Supporti: acciaio zincato preverniciato o plastificato; Aluzinc; acciaio inox; alluminio naturale, preverniciato o goffrato.

Trattamenti protettivi applicabili a richiesta: Preverniciatura con poliesteri, superpoliesteri (hd), pvdf, poliuretani pur/pa, con spessori compresi tra 15 µm a 55 µm. Disponibilità su richiesta di altri film e rivestimenti.

Dimensions: width 1045 (mm), length upon request from continuous production process.

Thicknesses (S): up to mm 0,8 - also non-standard on request.



Supports: prepainted or plasticized galvanized steel; Aluzinc; stainless steel; natural, prepainted or embossed aluminum.

Protective treatments for external support available on request: Pre-painting with polyester, superpolyester (hd), pvdf, polyurethane pur/pa, with thicknesses ranging from 15 µm to 55 µm. Availability on request of other films and coatings.

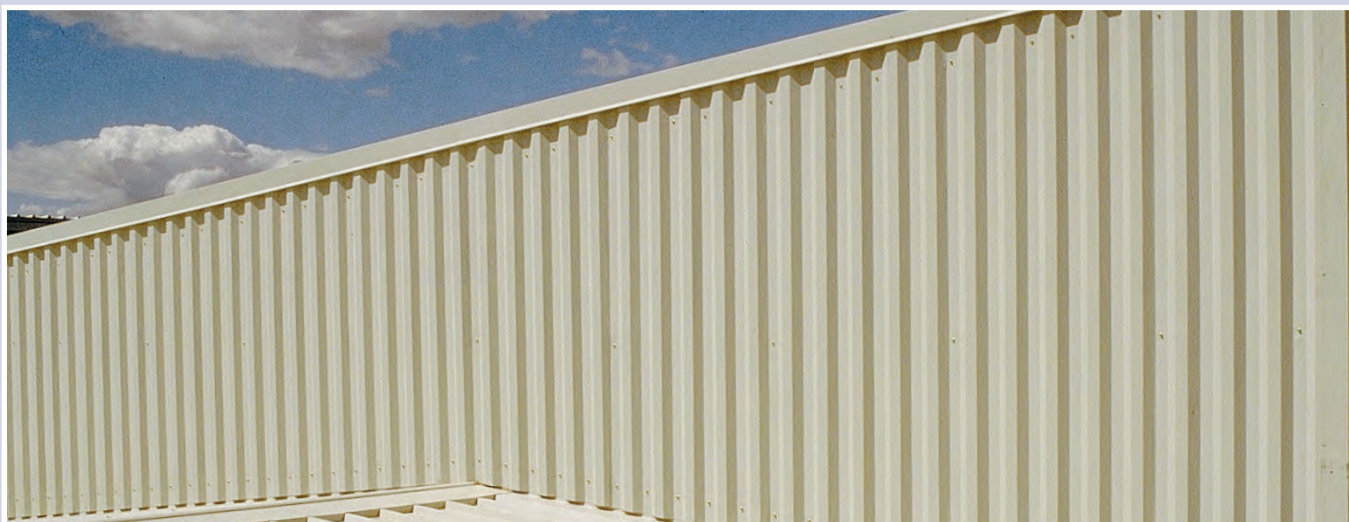
E/P 3000 - ACCIAIO / STEEL - CARATTERISTICHE STATICHE / STATIC CHARACTERISTICS													
spessore lamiera - sheet metal thickness	Peso weight	PROPRIETA' DI MASSA EFFICACI: - EFFECTIVE MASS PROPERTIES:											
		PROPRIETA' DI MASSA LORDE: GROSS MASS PROPERTY:											
		MOMENTO POSITIVO IN CAMPATA POSITIVE MOMENT ON SPAN						MOMENTO NEGATIVO SULL'APPOGGIO NEGATIVE MOMENT ON SUPPORT					
		A	J _{xG}	W _{e sup}	W _{e inf}	A _{eff}	J _{xG eff}	W _{e sup eff}	W _{e inf eff}	A _{eff}	J _{xG eff}	W _{e sup eff}	W _{e inf eff}
[kg/m ²]	cm ² /m	cm ⁴ /m	cm ³ /m	cm ³ /m	cm ² /m	cm ⁴ /m	cm ³ /m	cm ³ /m	cm ² /m	cm ⁴ /m	cm ³ /m	cm ³ /m	
0,5	4,6	5,531	10,677	6,280	6,280	4,734	7,983	4,019	5,647	4,470	7,622	5,660	3,712
0,6	5,6	6,638	12,813	7,537	7,537	5,802	10,051	5,168	6,906	5,802	10,051	6,906	5,168
0,7	6,5	7,744	14,949	8,794	8,794	6,904	12,225	6,411	8,188	6,904	12,225	8,188	6,411
0,8	7,4	8,850	17,086	10,051	10,051	8,035	14,489	7,738	9,486	8,035	14,489	9,486	7,738



I valori di portata in tabella non includono il peso proprio della lamiera grecata.
The capacity load shown in the table does not include the weight of the metal sheet itself.

E/P 3000: ACCIAIO / STEEL																	
Per i materiali ALUZINC e ACCIAIO INOX fare riferimento a questa tabella / Refer to these tables for data on Aluzinc and stainless steel materials																	
PORTATA DEL PROFILO IN daN/m ² CON FRECCIA ≤ L/200 SU UNA CAMPATA / SHEET CAPACITY, daN /m ² WITH DEFLECTION <L/200 OF A SPAN																	
Spessore / thickness																	
	Distanza tra gli appoggi "L" in metri / Pitch "L" in metres between the supports																
mm	1,00	1,25	1,50	1,75	2,00	2,25	2,50	2,75	3,00	3,25	3,50	3,75	4,00	4,25	4,50	4,75	5,00
0,50	422	338	282	241	211	175	142	117	99	84	72	63	55	49	44	39	36
	422	338	208	131	88	62	45	34	26	20	16	13	11	-	-	-	-
0,60	592	474	395	339	267	211	171	141	119	101	87	76	67	59	53	47	43
	592	431	250	157	105	74	54	41	31	25	20	16	13	11	-	-	-
0,70	789	631	526	409	313	247	200	166	139	119	102	89	78	69	62	56	50
	789	503	291	183	123	86	63	47	36	29	23	19	15	13	11	-	-
0,80	1011	809	639	469	359	284	230	190	160	136	117	102	90	80	71	64	57
	1011	575	333	210	140	99	72	54	42	33	26	21	18	15	12	-	-
PORTATA DEL PROFILO IN daN/m ² CON FRECCIA ≤ L/200 SU UNA CAMPATA / SHEET CAPACITY, daN /m ² WITH DEFLECTION <L/200 OF A SPAN																	
Spessore / thickness																	
	Distanza tra gli appoggi "L" in metri / Pitch "L" in metres between the supports																
mm	1,00	1,25	1,50	1,75	2,00	2,25	2,50	2,75	3,00	3,25	3,50	3,75	4,00	4,25	4,50	4,75	5,00
0,50	528	422	329	259	210	173	146	124	107	94	82	73	65	59	53	48	44
	528	422	329	251	168	118	86	65	50	39	31	25	21	18	15	13	11
0,60	741	557	420	329	265	218	183	156	134	117	103	91	81	73	66	59	53
	741	557	420	301	202	142	103	78	60	47	38	31	25	21	18	15	13
0,70	963	686	515	402	323	265	222	188	162	141	123	109	97	87	77	69	63
	963	686	515	351	235	165	120	91	70	55	44	36	29	25	21	18	15
0,80	1158	820	614	477	382	313	261	221	190	165	145	128	112	99	89	80	72
	1158	820	614	401	269	189	138	103	80	63	50	41	34	28	24	20	17
LEGENDA / INDEX:																	
Appoggio esterno 100 mm; appoggio interno 100 mm / End support 100 mm; internal support 100 mm - Coefficienti di sicurezza sulle portate allo SLU (γ _q) 1,40																	
Per la condizione di Stato Limite Ultimo (SLU) della lamiera / <i>Ultimate limit-state design of the corrugated sheet (SLU)</i>																	
Per la condizione di Stato Limite di Esercizio (SLE) della lamiera (F ≤ L/200) / <i>Serviceability limit of the corrugated sheet (SLE) (F ≤ L/200)</i>																	

I rapporti di prova pubblicati in questo catalogo vengono forniti a titolo puramente indicativo. I dati pubblicati sono stati calcolati secondo le Norme vigenti: NTC2018, Circolare esplicativa alle NTC2018, UNI EN 1993 (EC3). Per una corretta applicazione del prodotto sarà onere e cura del cliente e/o del progettista la redazione di calcoli appropriati con specifico riferimento al singolo impiego.

The test reports published in this catalogue are provided for indicative purposes only. The published data have been calculated according to the current regulations: NTC2018, Explanatory circular to NTC2018, UNI EN 1993 (EC3). For a correct application of the product, it will be responsibility and care of the customer and/or the designer to draw up appropriate calculations with specific reference to the individual use.



CLASSE / CLASS

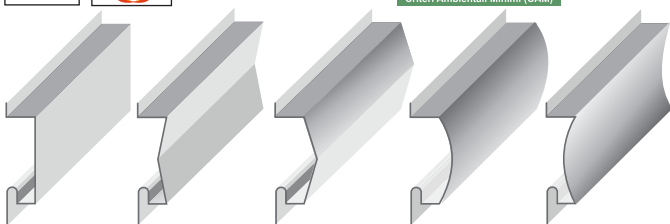

Lastra dogata per rivestimenti parete, Modul 25 è il sistema di facciata a doghe con fissaggio a scomparsa. È la soluzione ideale per il rinnovamento estetico di fabbricati ad uso commerciale ed industriale.

Slatted slab for wall cladding, Modul 25 is the slatted façade system with concealed fixing. It is the ideal solution for the aesthetic renovation of buildings for commercial and industrial use.

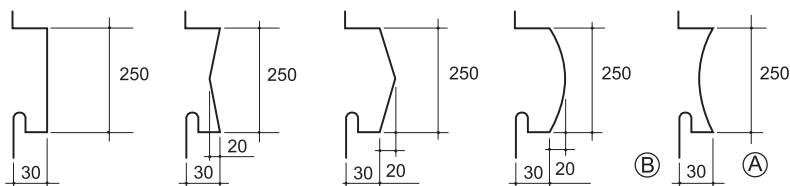

Nei disegni, A o B indicano il lato preverniciato desiderato.
In the drawings A or B show the wished pre-painted side.

Caratteristiche tecniche - Datasheet

Dimensioni: larghezza 250 (mm), lunghezza a richiesta.

Spessori: fino a mm 1,5 - anche non standard su richiesta.

Supporti: acciaio zincato preverniciato o plastificato; Aluzinc; acciaio inox; alluminio naturale, preverniciato o gofrato.

Trattamenti protettivi applicabili a richiesta: Preverniciatura con poliesteri, superpoliesteri (hd), pvdf, poliuretani pur/pa, con spessori compresi tra 15 µm a 55 µm. Disponibilità su richiesta di altri film e rivestimenti.

Dimensions: width 250 (mm), length upon request.

Thicknesses (S): up to mm 1,5 - also non-standard on request.

Supports: pre-painted or plasticized galvanized steel; Aluzinc; stainless steel; natural, pre-painted or embossed aluminum.

Protective treatments for external support available on request: Pre-painting with polyester, superpolyester (hd), pvdf, polyurethane pur/pa, with thicknesses ranging from 15 µm to 55 µm. Availability on request of other films and coatings.





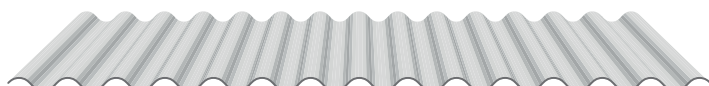

Ondul 18 è il sistema di rivestimento parete che, grazie alla sinuosità dell'onda, conferisce un effetto stilistico innovativo, personalizzabile ed essenziale. La facciata ventilata Ondul 18 è ideale per la posa in orizzontale.

Ondul 18 is the wall covering system which, thanks to the sinuosity of the wave, gives an innovative, customizable and essential stylistic effect. The ventilated facade Ondul 18 is ideal for horizontally laying.

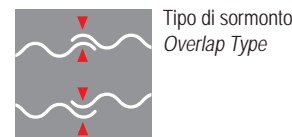
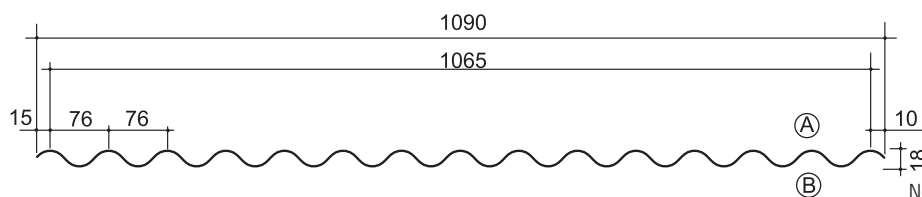

Nei disegni, A o B indicano il lato preverniciato desiderato.
In the drawings A or B show the wished prepainted side.

Nome del prodotto Product name	Numero greche Number of ribs (nr)	Interasse greche Pitch (mm)	Altezza onda Wave height (mm)	Larghezza modulo Covering width (mm)	Numero greche di sormonto Rib overlap (nr)
ONDUL 18	15	76	18	1065	1

COMPORTAMENTO AL FUOCO / FIRE REACTION	
Reazione al fuoco / Fire reaction class	A1 - UNI EN 13501-1
Comportamento al fuoco dall'esterno / External fire performance	Broof - UNI EN 13501-5 - CWFT - UNI ENV 1187

Caratteristiche tecniche - Datasheet

Dimensioni: larghezza 1065 (mm), lunghezza a richiesta da produzione in continuo.

Spessori: fino a mm 1,0 - anche non standard su richiesta.

Supporti: acciaio zincato preverniciato o plastificato; Aluzinc; acciaio inox; alluminio naturale, preverniciato o goffrato.

Trattamenti protettivi applicabili a richiesta: Preverniciatura con poliester, superpoliester (hd), pvdf, poliuretani pur/pa, con spessori compresi tra 15 µm a 55 µm. Disponibilità su richiesta di altri film e rivestimenti.

Dimensions: width 1065 (mm), length upon request from continuous production process.

Thicknesses (S): up to mm 1,0 - also non-standard on request.

Supports: prepainted or plasticized galvanized steel; Aluzinc; stainless steel; natural, prepainted or embossed aluminum.

Protective treatments for external support available on request: Pre-painting with polyester, superpolyester (hd), pvdf, polyurethane pur/pa, with thicknesses ranging from 15 µm to 55 µm. Availability on request of other films and coatings.



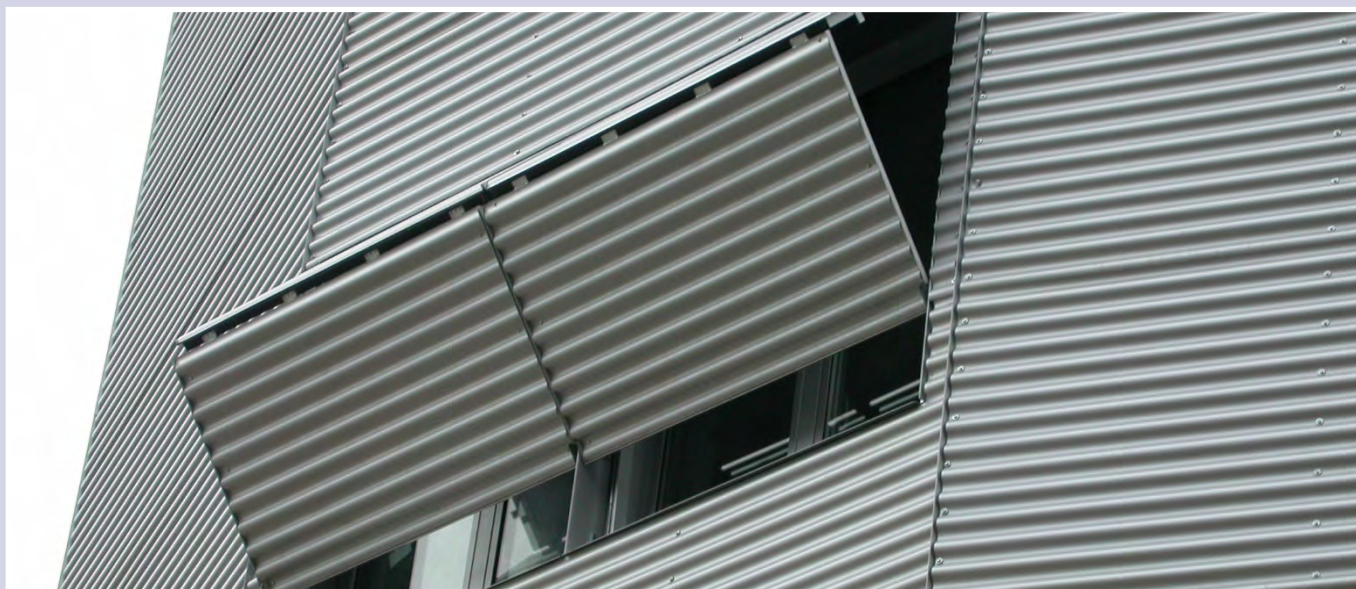

ACCIAIO / STEEL Per i materiali ALUZINC e ACCIAIO INOX fare riferimento a questa tabella / Refer to these tables for data on Aluzinc and stainless steel materials								
PORTATA DEL PROFILO IN daN/m ² CON FRECCIA ≤ L/200 SU UNA CAMPATA / SHEET CAPACITY, daN/m ² WITH DEFLECTION <L/200 OF A SPAN								
Distanza tra gli appoggi "L" in metri / Pitch "L" in metres between the supports								
Spess. / thick. (mm)	0,80	1	1,2	1,4	1,6	1,8	2	2,2
0,50	284	143	81	49	32	21	14	9
0,60	335	169	95	58	37	25	16	11
0,70	399	201	114	69	44	29	20	13
0,80	459	232	131	80	51	34	23	15
1,00	571	288	163	99	64	42	28	19

ACCIAIO / STEEL Per i materiali ALUZINC e ACCIAIO INOX fare riferimento a questa tabella / Refer to these tables for data on Aluzinc and stainless steel materials								
PORTATA DEL PROFILO IN daN/m ² CON FRECCIA ≤ L/200 SU TRE CAMPATE / SHEET CAPACITY, daN/m ² WITH DEFLECTION <L/200 OF A SPAN								
Distanza tra gli appoggi "L" in metri / Pitch "L" in metres between the supports								
Spess. / thick. (mm)	0,80	1	1,2	1,4	1,6	1,8	2	2,2
0,50	440	242	138	85	56	38	26	19
0,60	520	285	163	100	66	44	31	22
0,70	618	339	194	120	78	53	37	26
0,80	712	391	223	138	90	61	43	30
1,00	886	486	277	171	112	76	53	38

ALLUMINIO LEGA 3105 / ALUMINIUM ALLOY 3105								
PORTATA DEL PROFILO IN daN/m ² CON FRECCIA ≤ L/200 SU UNA CAMPATA / SHEET CAPACITY, daN/m ² WITH DEFLECTION <L/200 OF A SPAN								
Distanza tra gli appoggi "L" in metri / Pitch "L" in metres between the supports								
Spess. / thick. (mm)	0,80	1,00	1,2	1,4	1,6	1,8	2	2,2
0,50	97	49	28	17	11	7	5	3
0,60	116	58	33	20	13	8	6	4
0,70	135	68	38	23	15	10	7	4
0,80	155	78	44	27	17	11	8	5
1,00	190	96	54	33	21	14	9	6

ALLUMINIO LEGA 3105 / ALUMINIUM ALLOY 3105								
PORTATA DEL PROFILO IN daN/m ² CON FRECCIA ≤ L/200 SU TRE CAMPATE / SHEET CAPACITY, daN/m ² WITH DEFLECTION <L/200 OF A SPAN								
Distanza tra gli appoggi "L" in metri / Pitch "L" in metres between the supports								
Spess. / thick. (mm)	0,80	1,00	1,2	1,4	1,6	1,8	2	2,2
0,50	162	82	47	29	19	13	9	6
0,60	194	99	56	35	23	15	11	8
0,70	226	115	66	40	26	18	12	9
0,80	260	132	75	47	30	21	14	10
1,00	319	162	92	57	37	25	18	12



CLASSE / CLASS



Economicità, rapidità e razionalità di applicazione sono le parole d'ordine che contraddistinguono questa lamiera dall'elevato numero di greche dall'altezza ridotta (20 mm), ideale anche per rivestimenti parete.

Economy, speed and rationality of application are the watchwords that distinguish this sheet with the high number of low-height ribs (20 mm), also ideal for wall coverings.



CURVATURA CON TACCHETTATURA
NOTCHING CURVED METAL SHEET

Per maggiori informazioni vedi pagine da 36 a 39.
For more information see pages 36 to 39.

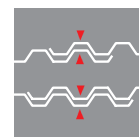
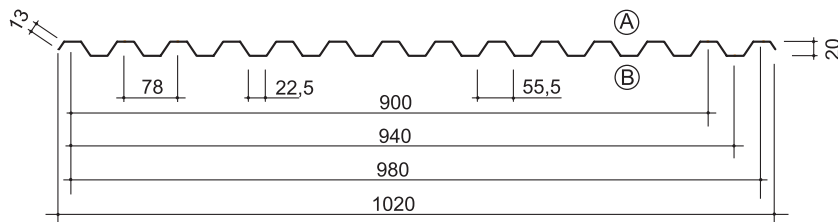

Tipo di sormonto
Overlap Type

Nei disegni, A o B indicano il lato preverniciato desiderato.
In the drawings A or B show the wished pre-painted side.

Nome del prodotto Product name	Numero greche Number of ribs	Interasse greche Pitch	Altezza greca Rib height	Larghezza greca Rib width	Base greca Rib long base	Larghezza modulo Covering width	Numero greche di sormonto Rib overlap
	(nr)	(mm)	(mm)	(mm)	(mm)	(mm)	(nr)
H20	14	78	20	22,5	51	900 - 940 - 980	2
H20	14	78	20	22,5	51	900 - 940 - 980	1,5

COMPORTAMENTO AL FUOCO / FIRE REACTION	
Reazione al fuoco / Fire reaction class	A1 - UNI EN 13501-1
Comportamento al fuoco dall'esterno / External fire performance	Roof - UNI EN 13501-5 - CWFT - UNI ENV 1187

Caratteristiche tecniche - Datasheet

Dimensioni: larghezza 900, 940, 980 (mm), lunghezza a richiesta da produzione in continuo.

Spessori: fino a mm 1,0 - anche non standard su richiesta.

Supporti: acciaio zincato preverniciato o plastificato; Aluzinc; acciaio inox; alluminio naturale, preverniciato o goffrato.

Trattamenti protettivi applicabili a richiesta: Preverniciatura con poliesteri, superpoliesteri (hd), pvdf, poliuretani pur/pa, con spessori compresi tra 15 µm a 55 µm. Disponibilità su richiesta di altri film e rivestimenti.

Dimensions: width 900, 940, 980 (mm), length upon request from continuous production process.

Thicknesses (S): up to mm 1,0 - also non-standard on request.

Supports: pre-painted or plasticized galvanized steel; Aluzinc; stainless steel; natural, pre-painted or embossed aluminum.

Protective treatments for external support available on request: Pre-painting with polyester, superpolyester (hd), pvdf, polyurethane pur/pa, with thicknesses ranging from 15 µm to 55 µm. Availability on request of other films and coatings.

H20 - ACCIAIO / STEEL - CARATTERISTICHE STATICHE / STATIC CHARACTERISTICS													
spessore lamiera - sheet metal thickness	Peso weight [kg/m ²]	PROPRIETA' DI MASSA LORDE: GROSS MASS PROPERTY:				PROPRIETA' DI MASSA EFFICACI: - EFFECTIVE MASS PROPERTIES:							
		A	J _{xG}	W _{e sup}	W _{e inf}	MOMENTO POSITIVO IN CAMPATA POSITIVE MOMENT ON SPAN				MOMENTO NEGATIVO SULL'APPOGGIO NEGATIVE MOMENT ON SUPPORT			
						A _{eff}	J _{xG eff}	W _{e sup eff}	W _{e inf eff}	A _{eff}	J _{xG eff}	W _{e sup eff}	W _{e inf eff}
						cm ² /m	cm ⁴ /m	cm ³ /m	cm ³ /m	cm ² /m	cm ⁴ /m	cm ³ /m	cm ³ /m
0,5	5,2	6,209	3,994	3,994	3,994	6,056	3,838	3,744	3,937	6,056	3,838	3,937	3,744
0,6	6,2	7,450	4,794	4,794	4,794	7,440	4,784	4,777	4,791	7,440	4,784	4,791	4,777
0,7	7,3	8,692	5,595	5,595	5,595	8,692	5,595	5,595	5,595	8,692	5,595	5,595	5,595
0,8	8,3	9,934	6,396	6,396	6,396	9,934	6,396	6,396	6,396	9,934	6,396	6,396	6,396
1,0	10,4	12,417	8,000	8,000	8,000	12,417	8,000	8,000	8,000	12,417	8,000	8,000	8,000

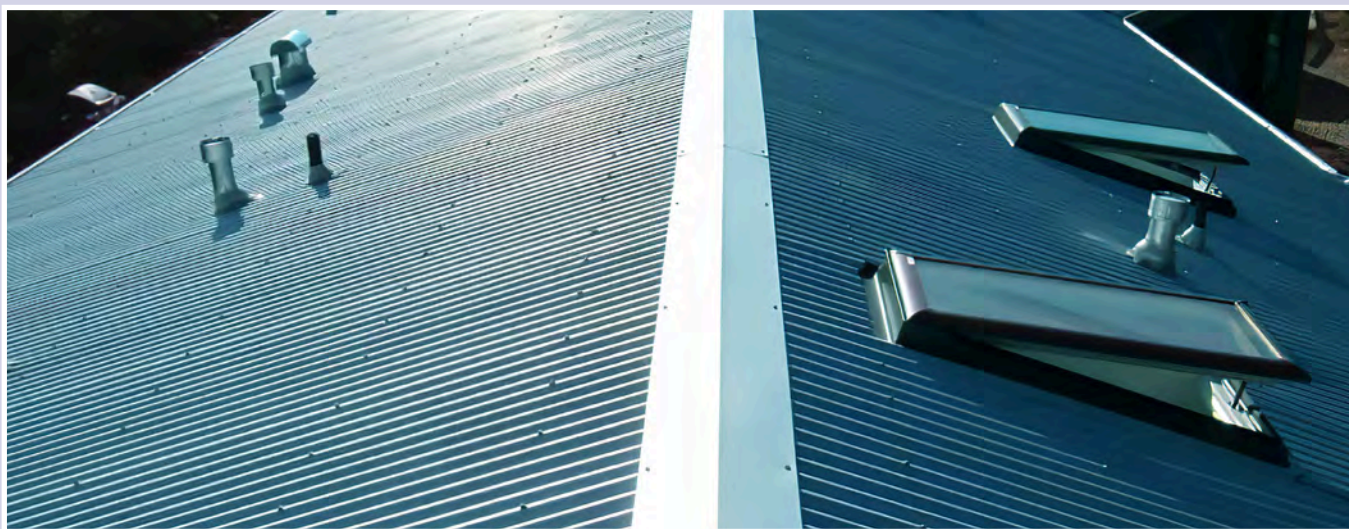

I valori di portata in tabella non includono il peso proprio della lamiera greccata.
The capacity load shown in the table does not include the weight of the metal sheet itself.

H20: ACCIAIO / STEEL

Per i materiali ALUZINC e ACCIAIO INOX fare riferimento a questa tabella / Refer to these tables for data on Aluzinc and stainless steel materials

PORTATA DEL PROFILO IN daN/m² CON FRECCIA ≤ L/200 SU UNA CAMPATA / SHEET CAPACITY, daN /m² WITH DEFLECTION <L/200 OF A SPAN

Spessore / thickness															
	Distanza tra gli appoggi "L" in metri / Pitch "L" in metres between the supports														
mm	1,00	1,25	1,50	1,75	2,00	2,25	2,50	2,75	3,00	3,25	3,50	3,75	4,00	4,25	4,50
0,50	580	371	258	189	145	114	93	77	64	55	47	41	36	32	29
	328	168	97	61	41	29	21	16	12	10	-	-	-	-	-
0,60	702	449	312	229	175	139	112	93	78	66	57	50	44	39	35
	394	202	117	74	49	35	25	19	15	11	-	-	-	-	-
0,70	826	529	367	270	207	163	132	109	92	78	67	59	52	46	41
	460	235	136	86	57	40	29	22	17	13	-	-	-	-	-
0,80	953	610	423	311	238	188	152	126	106	90	78	68	60	53	47
	526	269	156	98	66	46	34	25	19	15	-	-	-	-	-
0,90	1081	692	481	353	270	214	173	143	120	102	88	77	68	60	53
	592	303	175	110	74	52	38	28	22	17	14	1-	-	-	-
1,00	1212	776	539	396	303	239	194	160	135	115	99	86	76	67	60
	658	337	195	123	82	58	42	32	24	19	15	-	-	-	-

PORTATA DEL PROFILO IN daN/m² CON FRECCIA ≤ L/200 SU UNA CAMPATA / SHEET CAPACITY, daN /m² WITH DEFLECTION <L/200 OF A SPAN

Spessore / thickness															
	Distanza tra gli appoggi "L" in metri / Pitch "L" in metres between the supports														
mm	1,00	1,25	1,50	1,75	2,00	2,25	2,50	2,75	3,00	3,25	3,50	3,75	4,00	4,25	4,50
0,50	698	464	322	237	181	143	116	96	81	69	59	52	45	40	36
	629	322	186	117	79	55	40	30	23	18	15	12	-	-	-
0,60	869	561	390	286	219	173	140	116	97	83	72	62	55	49	43
	755	386	224	141	94	66	48	36	28	22	18	14	-	-	-
0,70	1033	661	459	337	258	204	165	137	115	98	84	73	65	57	51
	881	451	261	164	110	77	56	42	33	26	21	17	-	-	-
0,80	1191	762	529	389	298	235	191	157	132	113	97	85	74	66	59
	1007	515	298	188	126	88	64	48	37	29	23	19	16	-	-
0,90	1352	865	601	441	338	267	216	179	150	128	110	96	84	75	67
	1133	580	336	211	142	99	73	54	42	33	26	21	18	-	-
1,00	1515	970	673	495	379	299	242	200	168	143	124	108	95	84	75
	1259	645	373	235	157	111	81	61	47	37	29	24	20	-	-

LEGENDA / INDEX

	Appoggio esterno 100 mm; appoggio interno 100 mm / End support 100 mm; internal support 100 mm - Coefficienti di sicurezza sulle portate allo SLU (γ_Q) 1,40
	Per la condizione di Stato Limite Ultimo (SLU) della lamiera / <i>Ultimate limit-state design of the corrugated sheet (SLU)</i>
	Per la condizione di Stato Limite di Esercizio (SLE) della lamiera ($F \leq L/200$) / <i>Serviceability limit of the corrugated sheet (SLE) ($F \leq L/200$)</i>

I rapporti di prova pubblicati in questo catalogo vengono forniti a titolo puramente indicativo. I dati pubblicati sono stati calcolati secondo le Norme vigenti: NTC2018, Circolare esplicativa alle NTC2018, UNI EN 1993 (EC3). Per una corretta applicazione del prodotto sarà onere e cura del cliente e/o del progettista la redazione di calcoli appropriati con specifico riferimento al singolo impiego.

The test reports published in this catalogue are provided for indicative purposes only. The published data have been calculated according to the current regulations: NTC2018, Explanatory circular to NTC2018, UNI EN 1993 (EC3). For a correct application of the product, it will be responsibility and care of the customer and/or the designer to draw up appropriate calculations with specific reference to the individual use.



CLASSE / CLASS



Lamiera a 9 greche dall'efficace sistema di drenaggio e dall'estrema leggerezza, che la rende particolarmente indicata per la sovracopertura di tetti in fibrocemento.



9-rib sheet metal with an effective drainage system and extreme lightness, which makes it particularly suitable for covering fiber cement roofs.



CURVATURA CON TACCHETTATURA
NOTCHING CURVED METAL SHEET

Per maggiori informazioni vedi pagine da 36 a 39.
For more information see pages 36 to 39.

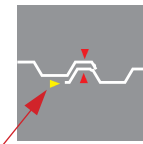
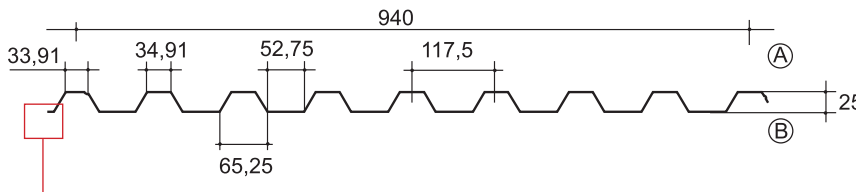

Tipo di sormonto
Overlap type

L'aletta d'appoggio impedisce l'abbassamento della greca della lamiera rendendo il sormonto semplice ed efficace - vedi dettaglio.

The support flap prevents the lowering of the corrugation of the sheet, making the overlap simple and effective - see detail.

Nei disegni, A o B indicano il lato preverniciato desiderato.
In the drawings A or B show the wished pre-painted side.

Nome del prodotto Product name	Numero greche Number of ribs (nr)	Interasse greche Pitch (mm)	Altezza greca Rib height (mm)	Larghezza greca Rib width (mm)	Base greca Rib long base (mm)	Larghezza modulo Covering width (mm)	Numero greche di sormonto Rib overlap (nr)
SL940	9	117,5	25	34,91	65,25	940	1

COMPORTAMENTO AL FUOCO / FIRE REACTION	
Reazione al fuoco / Fire reaction class	A1 - UNI EN 13501-1
Comportamento al fuoco dall'esterno / External fire performance	Roof - UNI EN 13501-5 - CWFT - UNI ENV 1187

Caratteristiche tecniche - Datasheet

Dimensioni: larghezza 940 (mm), lunghezza a richiesta da produzione in continuo.

Spessori: fino a mm 1,0 - anche non standard su richiesta.

Supporti: acciaio zincato preverniciato o plastificato; Aluzinc; acciaio inox; alluminio naturale, preverniciato o gofrato.

Trattamenti protettivi applicabili a richiesta: Preverniciatura con poliestere, superpoliestere (hd), pvdf, poliuretani pur/pa, con spessori compresi tra 15 µm a 55 µm. Disponibilità su richiesta di altri film e rivestimenti.

Dimensions: width 940 (mm), length upon request from continuous production process.

Thicknesses (S): up to mm 1,0 - also non-standard on request.

Supports: pre-painted or plasticized galvanized steel; Aluzinc; stainless steel; natural, pre-painted or embossed aluminum.

Protective treatments for external support available on request: Pre-painting with polyester, superpolyester (hd), pvdf, polyurethane pur/pa, with thicknesses ranging from 15 µm to 55 µm. Availability on request of other films and coatings.

SL940 - ACCIAIO / STEEL - CARATTERISTICHE STATICHE / STATIC CHARACTERISTICS													
spessore lamiera - sheet metal thickness	Peso weight	PROPRIETA' DI MASSA LORDE: GROSS MASS PROPERTY:				PROPRIETA' DI MASSA EFFICACI: - EFFECTIVE MASS PROPERTIES:							
						MOMENTO POSITIVO IN CAMPATA POSITIVE MOMENT ON SPAN				MOMENTO NEGATIVO SULL'APPOGGIO NEGATIVE MOMENT ON SUPPORT			
		A	J _{xG}	W _{e sup}	W _{e inf}	A _{eff}	J _{xG eff}	W _{e sup eff}	W _{e inf eff}	A _{eff}	J _{xG eff}	W _{e sup eff}	W _{e inf eff}
		[kg/m ²]	cm ² /m	cm ⁴ /m	cm ³ /m	cm ² /m	cm ⁴ /m	cm ³ /m	cm ³ /m	cm ² /m	cm ⁴ /m	cm ³ /m	cm ³ /m
0,5	5,2	6,208	6,976	4,972	6,358	5,691	5,865	3,833	6,049	5,000	5,171	4,544	3,796
0,6	6,2	7,450	8,372	5,968	7,631	7,003	7,436	4,983	7,380	6,211	6,583	5,560	5,002
0,7	7,2	8,691	9,768	6,963	8,903	8,350	9,070	6,211	8,722	7,476	8,067	6,588	6,325
0,8	8,3	9,933	11,166	7,959	10,177	9,723	10,743	7,496	10,070	8,790	9,610	7,626	7,751
1,0	10,4	12,416	13,962	9,953	12,726	12,416	13,962	9,953	12,726	11,537	12,823	9,720	10,860

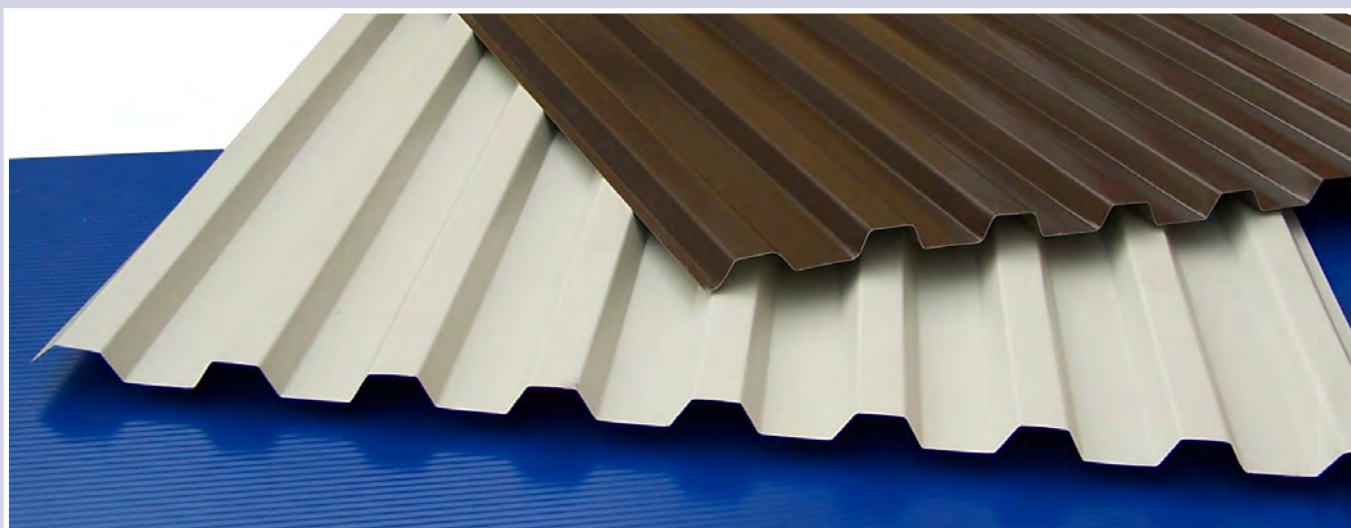

I valori di portata in tabella non includono il peso proprio della lamiera grecata.
The capacity load shown in the table does not include the weight of the metal sheet itself.

SL940: ACCIAIO / STEEL

Per i materiali ALUZINC e ACCIAIO INOX fare riferimento a questa tabella / Refer to these tables for data on Aluzinc and stainless steel materials

PORTATA DEL PROFILO IN daN/m² CON FRECCIA ≤ L/200 SU UNA CAMPATA / SHEET CAPACITY, daN /m² WITH DEFLECTION <L/200 OF A SPAN

Spessore / thickness																
	Distanza tra gli appoggi "L" in metri / Pitch "L" in metres between the supports															
mm	1,00	1,25	1,50	1,75	2,00	2,25	2,50	2,75	3,00	3,25	3,50	3,75	4,00	4,25	4,50	
0,50	711	455	316	232	178	140	114	94	79	67	58	51	44	39	35	
	573	294	170	107	72	50	37	28	21	17	13	11	-	-	-	
0,60	858	549	381	280	215	170	137	113	95	81	70	61	54	48	42	
	688	352	204	128	86	60	44	33	25	20	16	13	-	-	-	
0,70	1007	645	448	329	252	199	161	133	112	95	82	72	63	56	50	
	803	411	238	150	100	70	51	39	30	23	19	15	-	-	-	
0,80	1158	741	515	378	290	229	185	153	129	110	95	82	72	64	57	
	918	470	272	171	115	81	59	44	34	27	21	17	-	-	-	
0,90	1311	839	583	428	328	259	210	173	146	124	107	93	82	73	65	
	1033	529	306	193	129	91	66	50	38	30	24	20	-	-	-	
1,00	1465	938	651	478	366	289	234	194	163	139	120	104	92	81	72	
	1148	588	340	214	143	101	73	55	43	33	27	22	18	-	-	

PORTATA DEL PROFILO IN daN/m² CON FRECCIA ≤ L/200 SU UNA CAMPATA / SHEET CAPACITY, daN /m² WITH DEFLECTION <L/200 OF A SPAN

Spessore / thickness																
	Distanza tra gli appoggi "L" in metri / Pitch "L" in metres between the supports															
mm	1,00	1,25	1,50	1,75	2,00	2,25	2,50	2,75	3,00	3,25	3,50	3,75	4,00	4,25	4,50	
0,50	726	499	365	278	220	176	142	117	99	84	73	63	56	49	44	
	726	499	325	205	137	96	70	53	41	32	26	21	-	-	-	
0,60	915	625	455	346	268	212	172	142	119	102	88	76	67	59	53	
	915	625	390	246	165	116	84	63	49	38	31	25	21	-	-	
0,70	1109	755	547	411	315	249	201	166	140	119	103	90	79	70	62	
	1109	755	456	287	192	135	98	74	57	45	36	29	24	-	-	
0,80	1310	887	641	473	362	286	232	191	161	137	118	103	90	80	71	
	1310	887	521	328	220	154	112	85	65	51	41	33	27	23	-	
0,90	1515	1023	728	535	410	324	262	217	182	155	134	117	102	91	81	
	1515	1012	586	369	247	174	127	95	73	58	46	37	31	26	22	
1,00	1725	1161	814	598	458	362	293	242	203	173	150	130	114	101	90	
	1725	1125	651	410	275	193	141	106	81	64	51	42	34	29	24	

LEGENDA / INDEX

Appoggio esterno 100 mm; appoggio interno 100 mm / End support 100 mm; internal support 100 mm

Per la condizione di Stato Limite Ultimo (SLU) della lamiera / *Ultimate limit-state design of the corrugated sheet (SLU)*

Per la condizione di Stato Limite di Esercizio (SLE) della lamiera ($F \leq L/200$) / *Serviceability limit of the corrugated sheet (SLE) ($F \leq L/200$)*

I rapporti di prova pubblicati in questo catalogo vengono forniti a titolo puramente indicativo. I dati pubblicati sono stati calcolati secondo le Norme vigenti: NTC2018, Circolare esplicativa alle NTC2018, UNI EN 1993 (EC3). Per una corretta applicazione del prodotto sarà onere e cura del cliente e/o del progettista la redazione di calcoli appropriati con specifico riferimento al singolo impiego.

The test reports published in this catalogue are provided for indicative purposes only. The published data have been calculated according to the current regulations: NTC2018, Explanatory circular to NTC2018, UNI EN 1993 (EC3). For a correct application of the product, it will be responsibility and care of the customer and/or the designer to draw up appropriate calculations with specific reference to the individual use.

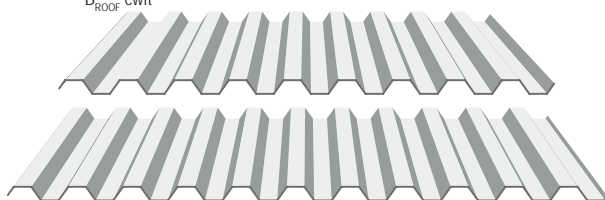

Un prodotto completo la cui tenuta è assicurata dal sormonto ad una greca e mezza (con altezza 28 mm). Adatto per coperture, soffittature e rivestimenti di facciata, consente una vasta gamma di lavorazioni: curvatura mediante calandratura e tacchettatura, piegatura a shed e dentellatura, per soddisfare ogni esigenza di impiego.

A complete product whose seal is ensured by the overlap to one and a half rib (with a height of 28 mm). Suitable for roofing, ceilings and facade cladding, it allows a wide range of processes: bending by calendaring and notching, shed bending and notching, to satisfy every need of use.



CURVATURA CON TACCHETTATURA
NOTCHING CURVED METAL SHEET



CURVATURA CON CALANDRATURA
CALENDERED CURVED SHEET

Per maggiori informazioni vedi pagine da 36 a 39.
For more information see pages 36 to 39.

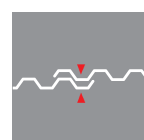
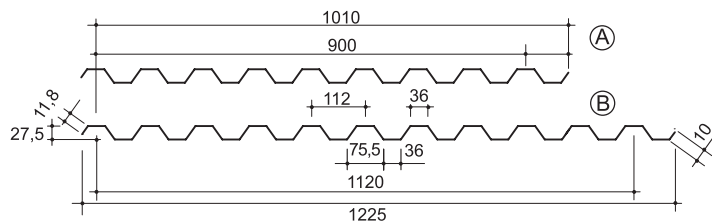

Tipo di sormonto
Overlap Type

Nei disegni, A o B indicano il lato preverniciato desiderato.
In the drawings A or B show the wished pre-painted side.

Nome del prodotto Product name	Numero greche Number of ribs	Interasse greche Pitch	Altezza greca Rib height	Larghezza greca Rib width	Base greca Rib long base	Larghezza modulo Covering width	Numero greche di sormonto Rib overlap
	(nr)	(mm)	(mm)	(mm)	(mm)	(mm)	(nr)
H28 (1010)	9	112	27,5	36	76	900	1,5
H28 (1225)	11	112	27,5	36	76	1120	1,5

COMPORTAMENTO AL FUOCO / FIRE REACTION	
Reazione al fuoco / Fire reaction class	A1 - UNI EN 13501-1
Comportamento al fuoco dall'esterno / External fire performance	Roof - UNI EN 13501-5 - CWFT - UNI ENV 1187

Caratteristiche tecniche - Datasheet

Dimensioni: larghezza 900/1120 (mm), lunghezza a richiesta da produzione in continuo.

Spessori: fino a mm 1,0 - anche non standard su richiesta.

Supporti: acciaio zincato preverniciato o plastificato; Aluzinc; acciaio inox; alluminio naturale, preverniciato o gofrato.

Trattamenti protettivi applicabili a richiesta: Preverniciatura con poliesteri, superpoliesteri (hd), pvdf, poliuretani pur/pa, con spessori compresi tra 15 µm a 55 µm. Disponibilità su richiesta di altri film e rivestimenti.

Dimensions: width 900/1120 (mm), length upon request from continuous production process.

Thicknesses (S): up to mm 1,0 - also non-standard on request.

Supports: pre-painted or plasticized galvanized steel; Aluzinc; stainless steel; natural, pre-painted or embossed aluminum.

Protective treatments for external support available on request: Pre-painting with polyester, superpolyester (hd), pvdf, polyurethane pur/pa, with thicknesses ranging from 15 µm to 55 µm. Availability on request of other films and coatings.

H28 - ACCIAIO / STEEL - CARATTERISTICHE STATICHE / STATIC CHARACTERISTICS													
spessore lamiera - sheet metal thickness	Peso weight (passo) 900 mm	PROPRIETA' DI MASSA LORDE: GROSS MASS PROPERTY:				PROPRIETA' DI MASSA EFFICACI: - EFFECTIVE MASS PROPERTIES:							
						MOMENTO POSITIVO IN CAMPATA POSITIVE MOMENT ON SPAN				MOMENTO NEGATIVO SULL'APPOGGIO NEGATIVE MOMENT ON SUPPORT			
		A	J _{xG}	W _{e sup}	W _{e inf}	A _{eff}	J _{xG eff}	W _{e sup eff}	W _{e inf eff}	A _{eff}	J _{xG eff}	W _{e sup eff}	W _{e inf eff}
		cm ² /m	cm ⁴ /m	cm ³ /m	cm ³ /m	cm ² /m	cm ⁴ /m	cm ³ /m	cm ³ /m	cm ² /m	cm ⁴ /m	cm ³ /m	cm ³ /m
0,5	5,5	6,250	7,992	5,812	5,812	5,666	6,772	4,465	5,492	5,666	6,772	5,492	4,465
0,6	6,5	7,500	9,592	6,976	6,976	6,984	8,544	5,786	6,709	6,984	8,544	6,709	5,786
0,7	7,6	8,750	11,191	8,139	8,139	8,342	10,382	7,198	7,939	8,342	10,382	7,939	7,198
0,8	8,7	10,001	12,792	9,303	9,303	9,729	12,264	8,677	9,175	9,729	12,264	9,175	8,677
1,0	10,9	12,501	15,995	11,633	11,633	12,501	15,995	11,633	11,633	12,501	15,995	11,633	11,633



I valori di portata in tabella non includono il peso proprio della lamiera greccata.
The capacity load shown in the table does not include the weight of the metal sheet itself.

H28: ACCIAIO / STEEL

Per i materiali ALUZINC e ACCIAIO INOX fare riferimento a questa tabella / Refer to these tables for data on Aluzinc and stainless steel materials

PORTATA DEL PROFILO IN daN/m² CON FRECCIA ≤ L/200 SU UNA CAMPATA / SHEET CAPACITY, daN /m² WITH DEFLECTION <L/200 OF A SPAN

Spessore / thickness																		
	Distanza tra gli appoggi "L" in metri / Pitch "L" in metres between the supports																	
mm	1,00	1,25	1,50	1,75	2,00	2,25	2,50	2,75	3,00	3,25	3,50	3,75	4,00	4,25	4,50	4,75	5,00	
0,50	832	532	370	272	208	164	133	110	92	79	68	59	52	46	41	37	33	
0,60	1005	643	446	328	251	198	161	133	112	95	82	71	63	56	50	45	40	
0,70	1179	755	524	385	295	233	189	156	131	112	96	84	74	65	58	52	47	
0,80	1356	868	603	443	339	268	217	179	151	128	111	96	85	75	67	60	54	
0,90	1535	983	682	501	384	303	246	203	171	145	125	109	96	85	76	68	61	
1,00	1717	1099	763	561	429	339	275	227	191	163	140	122	107	95	85	76	69	

PORTATA DEL PROFILO IN daN/m² CON FRECCIA ≤ L/200 SU UNA CAMPATA / SHEET CAPACITY, daN /m² WITH DEFLECTION <L/200 OF A SPAN

Spessore / thickness																		
	Distanza tra gli appoggi "L" in metri / Pitch "L" in metres between the supports																	
mm	1,00	1,25	1,50	1,75	2,00	2,25	2,50	2,75	3,00	3,25	3,50	3,75	4,00	4,25	4,50	4,75	5,00	
0,50	809	560	411	315	249	202	166	138	116	98	85	74	65	58	51	46	42	
0,60	1024	704	515	393	310	248	201	166	140	119	103	89	78	70	62	56	50	
0,70	1246	853	621	472	369	291	236	195	164	140	120	105	92	82	73	65	59	
0,80	1475	1005	729	554	424	335	271	224	188	161	138	121	106	94	84	75	68	
0,90	1710	1161	841	627	480	379	307	254	213	182	157	136	120	106	95	85	77	
1,00	1951	1321	954	701	536	424	343	284	238	203	175	153	134	119	106	95	86	

LEGENDA / INDEX

Appoggio esterno 100 mm; appoggio interno 100 mm / End support 100 mm; internal support 100 mm

Per la condizione di Stato Limite Ultimo (SLU) della lamiera / *Ultimate limit-state design of the corrugated sheet (SLU)*

Per la condizione di Stato Limite di Esercizio (SLE) della lamiera ($F \leq L/200$) / *Serviceability limit of the corrugated sheet (SLE) ($F \leq L/200$)*

I rapporti di prova pubblicati in questo catalogo vengono forniti a titolo puramente indicativo. I dati pubblicati sono stati calcolati secondo le Norme vigenti: NTC2018, Circolare esplicativa alle NTC2018, UNI EN 1993 (EC3). Per una corretta applicazione del prodotto sarà onere e cura del cliente e/o del progettista la redazione di calcoli appropriati con specifico riferimento al singolo impiego.

The test reports published in this catalogue are provided for indicative purposes only. The published data have been calculated according to the current regulations: NTC2018, Explanatory circular to NTC2018, UNI EN 1993 (EC3). For a correct application of the product, it will be responsibility and care of the customer and/or the designer to draw up appropriate calculations with specific reference to the individual use.



CLASSE / CLASS



Eurosilma si adatta facilmente ad ogni tipologia di copertura, in particolare a quelle curve. Versatile e dal design sobrio, questa lamiera è provvista di piedino di appoggio per facilitare il montaggio ed evitare lo schiacciamento della greca di sormonto durante la posa.

Eurosilma easily adapts to any type of roof, especially curved ones. Versatile and with a sober design, this metal sheet is equipped with a support foot to facilitate assembly and avoid crushing the overlap rib during installation.



CURVATURA CON TACCHETTATURA
NOTCHING CURVED METAL SHEET

Per maggiori informazioni vedi pagine da 36 a 39.
For more information see pages 36 to 39.

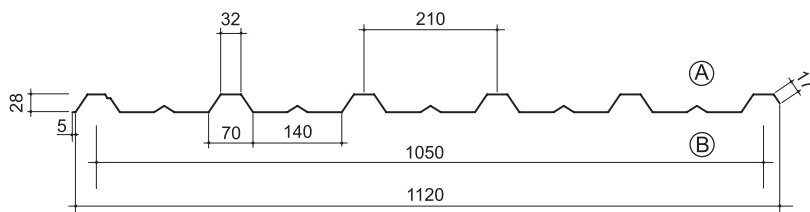

Nei disegni, A o B indicano il lato preverniciato desiderato.
In the drawings A or B show the wished pre-painted side.

Nome del prodotto Product name	Numero greche Number of ribs (nr)	Interasse greche Pitch (mm)	Altezza greca Rib height (mm)	Larghezza greca Rib width (mm)	Base greca Rib long base (mm)	Larghezza modulo Covering width (mm)	Numero greche di sormonto Rib overlap (nr)
EUROSILMA	6	210	28	32	70	1050	1

COMPORTAMENTO AL FUOCO / FIRE REACTION	
Reazione al fuoco / Fire reaction class	A1 - UNI EN 13501-1
Comportamento al fuoco dall'esterno / External fire performance	Roof - UNI EN 13501-5 - CWFT - UNI ENV 1187

Caratteristiche tecniche - Datasheet

Dimensioni: larghezza 1050 (mm), lunghezza a richiesta da produzione in continuo.

Spessori: fino a mm 1,0 - anche non standard su richiesta.

Supporti: acciaio zincato preverniciato o plastificato; Aluzinc; acciaio inox; alluminio naturale, preverniciato o gofrato.

Trattamenti protettivi applicabili a richiesta: Preverniciatura con poliestere, superpoliestere (hd), pvdf, poliuretani pur/pa, con spessori compresi tra 15 µm a 55 µm. Disponibilità su richiesta di altri film e rivestimenti.

Dimensions: width 1050 (mm), length upon request from continuous production process.

Thicknesses (S): up to mm 1,0 - also non-standard on request.

Supports: pre-painted or plasticized galvanized steel; Aluzinc; stainless steel; natural, pre-painted or embossed aluminum.

Protective treatments for external support available on request: Pre-painting with polyester, superpolyester (hd), pvdf, polyurethane pur/pa, with thicknesses ranging from 15 µm to 55 µm. Availability on request of other films and coatings.

EUROSILMA - ACCIAIO / STEEL - CARATTERISTICHE STATICHE / STATIC CHARACTERISTICS

spessore lamiera - sheet metal thickness	Peso weight	PROPRIETA' DI MASSA EFFICACI: - EFFECTIVE MASS PROPERTIES:											
		PROPRIETA' DI MASSA LORDE: GROSS MASS PROPERTY:											
						MOMENTO POSITIVO IN CAMPATA POSITIVE MOMENT ON SPAN				MOMENTO NEGATIVO SULL'APPOGGIO NEGATIVE MOMENT ON SUPPORT			
		[kg/m ²]	A	J _{xG}	W _{e sup}	W _{e inf}	A _{eff}	J _{xG eff}	W _{e sup eff}	W _{e inf eff}	A _{eff}	J _{xG eff}	W _{e sup eff}
	cm ² /m	cm ⁴ /m	cm ³ /m	cm ³ /m	cm ² /m	cm ⁴ /m	cm ³ /m	cm ³ /m	cm ² /m	cm ⁴ /m	cm ³ /m	cm ³ /m	
0,5	5,2	5,720	6,660	3,310	8,455	5,489	5,688	2,713	8,088	3,809	4,972	3,053	4,244
0,6	6,3	6,864	7,993	3,972	10,147	6,679	7,224	3,493	9,869	4,846	6,310	3,726	5,704
0,7	7,3	8,008	9,326	4,635	11,840	7,886	8,823	4,318	11,664	5,961	7,707	4,405	7,337
0,8	8,4	9,152	10,660	5,297	13,533	9,103	10,460	5,170	13,465	7,149	9,151	5,089	9,133
1,0	10,4	11,440	13,329	6,624	16,922	11,440	13,329	6,624	16,922	9,729	12,147	6,468	13,176



I valori di portata in tabella non includono il peso proprio della lamiera greccata.
The capacity load shown in the table does not include the weight of the metal sheet itself.

EUROSILMA: ACCIAIO / STEEL

Per i materiali ALUZINC e ACCIAIO INOX fare riferimento a questa tabella / Refer to these tables for data on Aluzinc and stainless steel materials

PORTATA DEL PROFILO IN daN/m² CON FRECCIA ≤ L/200 SU UNA CAMPATA / SHEET CAPACITY, daN /m² WITH DEFLECTION <L/200 OF A SPAN

Spessore / thickness	 Distanza tra gli appoggi "L" in metri / Pitch "L" in metres between the supports														
	mm	1,00	1,25	1,50	1,75	2,00	2,25	2,50	2,75	3,00	3,25	3,50	3,75	4,00	4,25
0,50	376	241	167	123	94	74	60	50	42	36	31	27	24	21	19
	376	239	139	87	58	41	30	22	17	14	11	-	-	-	-
0,60	485	310	215	158	121	96	78	64	54	46	40	34	30	27	24
	485	304	176	111	74	52	38	29	22	17	14	11	-	-	-
0,70	599	383	266	196	150	118	96	79	67	57	49	43	37	33	30
	599	371	215	135	91	64	46	35	27	21	17	14	-	-	-
0,80	717	459	319	234	179	142	115	95	80	68	59	51	45	40	35
	717	440	255	160	107	75	55	41	32	25	20	16	-	-	-
0,90	827	529	367	270	207	163	132	109	92	78	67	59	52	46	41
	827	505	292	184	123	87	63	47	37	29	23	19	15	-	-
1,00	919	588	408	300	230	181	147	121	102	87	75	65	57	51	45
	919	561	325	204	137	96	70	53	41	32	26	21	17	-	-

PORTATA DEL PROFILO IN daN/m² CON FRECCIA ≤ L/200 SU UNA CAMPATA / SHEET CAPACITY, daN /m² WITH DEFLECTION <L/200 OF A SPAN

Spessore / thickness	 Distanza tra gli appoggi "L" in metri / Pitch "L" in metres between the supports														
	mm	1,00	1,25	1,50	1,75	2,00	2,25	2,50	2,75	3,00	3,25	3,50	3,75	4,00	4,25
0,50	418	289	212	162	128	104	85	70	59	50	43	38	33	29	26
	418	289	212	162	112	79	57	43	33	26	21	17	-	-	-
0,60	531	365	267	203	160	128	103	85	72	61	53	46	40	36	32
	531	365	267	203	142	100	73	55	42	33	27	22	-	-	-
0,70	649	444	323	246	191	151	122	101	85	72	62	54	48	42	38
	649	444	323	246	174	122	89	67	51	40	32	26	-	-	-
0,80	770	524	380	288	221	174	141	117	98	84	72	63	55	49	44
	770	524	380	288	206	145	105	79	61	48	38	31	-	-	-
0,90	893	606	439	327	250	198	160	132	111	95	82	71	63	55	49
	893	606	439	327	236	166	121	91	70	55	44	36	29	-	-
1,00	1019	690	498	366	280	221	179	148	125	106	92	80	70	62	55
	1019	690	498	366	262	184	134	101	78	61	49	40	33	-	-

LEGENDA / INDEX

Appoggio esterno 100 mm; appoggio interno 100 mm / End support 100 mm; internal support 100 mm
 Valori carico ammissibile uniformemente distribuito per la condizione di Stato Limite Ultimo (SLU) della lamiera
 Per la condizione di Stato Limite di Esercizio (SLE) della lamiera (F ≤ L/200) / Serviceability limit of the corrugated sheet (SLE) (F ≤ L/200)

I rapporti di prova pubblicati in questo catalogo vengono forniti a titolo puramente indicativo. I dati pubblicati sono stati calcolati secondo le Norme vigenti: NTC2018, Circolare esplicativa alle NTC2018, UNI EN 1993 (EC3). Per una corretta applicazione del prodotto sarà onere e cura del cliente e/o del progettista la redazione di calcoli appropriati con specifico riferimento al singolo impiego.

The test reports published in this catalogue are provided for indicative purposes only. The published data have been calculated according to the current regulations: NTC2018, Explanatory circular to NTC2018, UNI EN 1993 (EC3). For a correct application of the product, it will be responsibility and care of the customer and/or the designer to draw up appropriate calculations with specific reference to the individual use.



CLASSE / CLASS

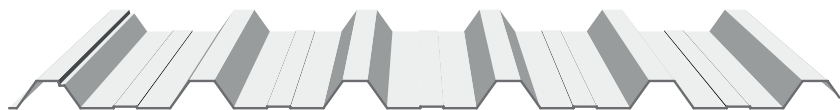

Viene prodotto con tutti i tipi di metallo, ma la versione in acciaio inox lo rende uno dei profili più resistenti sul mercato. Robusto e versatile, anche grazie all'esclusivo piedino d'appoggio, è ideale per le nuove costruzioni e per il risanamento dei vecchi edifici.

It is produced with all types of metal, but the stainless steel version makes it one of the most resistant profiles on the market. Sturdy and versatile, also thanks to the exclusive support foot, it is ideal for new buildings and for the renovation of old buildings.



CURVATURA CON TACCHETTATURA
NOTCHING CURVED METAL SHEET

Per maggiori informazioni vedi pagine da 36 a 39.
For more information see pages 36 to 39.

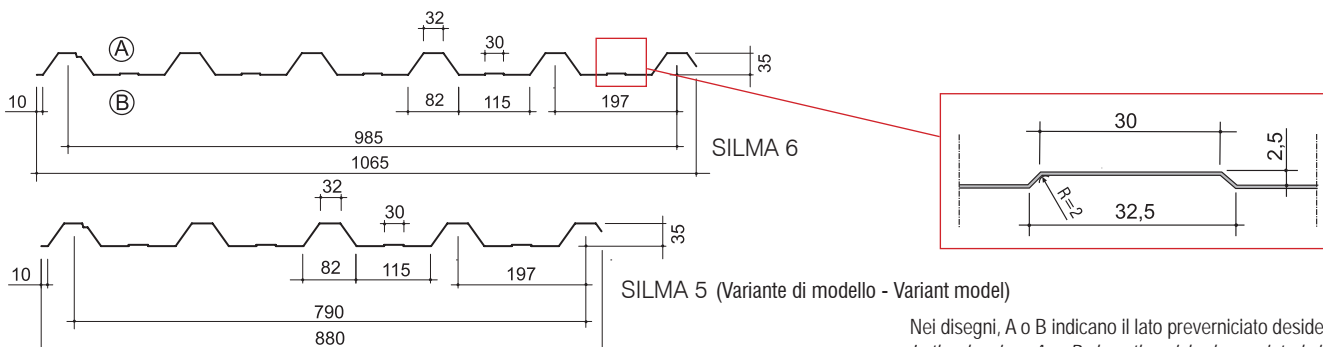

Nei disegni, A o B indicano il lato preverniciato desiderato.
In the drawings A or B show the wished prepainted side.

Nome del prodotto Product name	Numero greche Number of ribs (nr)	Interasse greche Pitch (mm)	Altezza greca Rib height (mm)	Larghezza greca Rib width (mm)	Base greca Rib long base (mm)	Larghezza modulo Covering width (mm)	Numero greche di sormonto Rib overlap (nr)
SILMA 6	6	197	35	32	82	985	1
SILMA 5	5	197	35	32	82	790	1

COMPORTAMENTO AL FUOCO / FIRE REACTION	
Reazione al fuoco / Fire reaction class	A1 - UNI EN 13501-1
Comportamento al fuoco dall'esterno / External fire performance	Broof - UNI EN 13501-5 - CWFT - UNI ENV 1187

Caratteristiche tecniche - Datasheet

Dimensioni: larghezza 985 - 790 (mm), lunghezza a richiesta da produzione in continuo.

Spessori: fino a mm 1,0 - anche non standard su richiesta.

Supporti: acciaio zincato preverniciato o plastificato; Aluzinc; acciaio inox; alluminio naturale, preverniciato o gofrato.

Trattamenti protettivi applicabili a richiesta: Preverniciatura con poliesteri, superpoliesteri (hd), pvdf, poliuretani pur/pa, con spessori compresi tra 15 µm a 55 µm. Disponibilità su richiesta di altri film e rivestimenti.

Dimensions: width 985 - 790 (mm), length upon request from continuous production process.

Thicknesses (S): up to mm 1,0 - also non-standard on request.

Supports: prepainted or plasticized galvanized steel; Aluzinc; stainless steel; natural, prepainted or embossed aluminum.

Protective treatments for external support available on request: Pre-painting with polyester, superpolyester (hd), pvdf, polyurethane pur/pa, with thicknesses ranging from 15 µm to 55 µm. Availability on request of other films and coatings.

SILMA 6 - ACCIAIO / STEEL - CARATTERISTICHE STATICHE / STATIC CHARACTERISTICS													
spessore lamiera - sheet metal thickness	Peso weight (passo) 985 mm	PROPRIETA' DI MASSA LORDE: GROSS MASS PROPERTY:				PROPRIETA' DI MASSA EFFICACI: - EFFECTIVE MASS PROPERTIES:							
						MOMENTO POSITIVO IN CAMPATA POSITIVE MOMENT ON SPAN				MOMENTO NEGATIVO SULL'APPOGGIO NEGATIVE MOMENT ON SUPPORT			
		A	J _{xG}	W _{e sup}	W _{e inf}	A _{eff}	J _{xG eff}	W _{e sup eff}	W _{e inf eff}	A _{eff}	J _{xG eff}	W _{e sup eff}	W _{e inf eff}
		[kg/m ²]	cm ² /m	cm ⁴ /m	cm ³ /m	cm ² /m	cm ⁴ /m	cm ³ /m	cm ³ /m	cm ² /m	cm ⁴ /m	cm ³ /m	cm ³ /m
0,5	5,0	5,921	11,192	4,741	9,824	5,570	9,539	3,830	9,446	4,285	8,385	4,332	5,360
0,6	5,9	7,105	13,431	5,690	11,789	6,908	12,303	5,067	11,476	5,382	10,611	5,293	7,096
0,7	6,9	8,289	15,671	6,638	13,755	8,159	14,933	6,226	13,556	6,543	12,937	6,267	9,011
0,8	7,9	9,473	17,911	7,587	15,722	9,421	17,618	7,422	15,644	7,763	15,342	7,248	11,090
1,0	9,8	11,841	22,394	9,486	19,656	11,841	22,394	9,486	19,656	10,357	20,326	9,227	15,670



I valori di portata in tabella non includono il peso proprio della lamiera grecata.
The capacity load shown in the table does not include the weight of the metal sheet itself.

SILMA 6: ACCIAIO / STEEL

Per i materiali ALUZINC e ACCIAIO INOX fare riferimento a questa tabella / Refer to these tables for data on Aluzinc and stainless steel materials

PORTATA DEL PROFILO IN daN/m² CON FRECCIA ≤ L/200 SU UNA CAMPATA / SHEET CAPACITY, daN /m² WITH DEFLECTION <L/200 OF A SPAN

Spessore / thickness															
	Distanza tra gli appoggi "L" in metri / Pitch "L" in metres between the supports														
mm	1,00	1,25	1,50	1,75	2,00	2,25	2,50	2,75	3,00	3,25	3,50	3,75	4,00	4,25	4,50
0,50	479	340	236	173	133	105	85	70	59	50	43	38	33	29	26
0,60	479	340	232	146	98	69	50	38	29	23	18	15	-	-	-
0,70	671	450	312	229	176	139	112	93	78	67	57	50	44	39	35
0,80	671	450	300	189	126	89	65	49	37	29	24	19	-	-	-
0,90	864	553	384	282	216	171	138	114	96	82	70	61	54	48	43
1,00	864	553	364	229	153	108	79	59	45	36	29	23	-	-	-
1,10	1029	659	457	336	257	203	165	136	114	97	84	73	64	57	51
1,20	1029	659	429	270	181	127	93	70	54	42	34	27	-	-	-
1,30	1184	758	526	387	296	234	189	157	132	112	97	84	74	66	58
1,40	1184	758	491	309	207	145	106	80	61	48	39	31	26	-	-
1,50	1366	874	607	446	342	270	219	181	152	129	112	97	85	76	67
1,60	1366	874	545	343	230	162	118	89	68	54	43	35	29	-	-

PORTATA DEL PROFILO IN daN/m² CON FRECCIA ≤ L/200 SU UNA CAMPATA / SHEET CAPACITY, daN /m² WITH DEFLECTION <L/200 OF A SPAN

Spessore / thickness															
	Distanza tra gli appoggi "L" in metri / Pitch "L" in metres between the supports														
mm	1,00	1,25	1,50	1,75	2,00	2,25	2,50	2,75	3,00	3,25	3,50	3,75	4,00	4,25	4,50
0,50	527	370	274	212	169	138	114	97	83	71	61	53	47	42	37
0,60	527	370	274	212	169	132	96	72	56	44	35	28	23	-	-
0,70	676	471	348	268	213	173	144	121	102	87	75	65	57	51	45
0,80	676	471	348	268	213	170	124	93	72	56	45	37	30	-	-
0,90	832	577	424	326	258	209	173	144	121	103	89	77	68	60	54
1,00	832	577	424	326	258	206	150	113	87	68	55	45	37	-	-
1,10	993	686	503	385	304	246	201	166	140	119	103	89	79	70	62
1,20	993	686	503	385	304	243	177	133	103	81	65	53	43	-	-
1,30	1158	797	583	445	351	282	228	189	159	135	117	102	89	79	71
1,40	1158	797	583	445	351	278	203	153	117	92	74	60	50	41	35
1,50	1395	959	701	535	422	337	273	226	190	162	139	121	107	95	84
1,60	1395	959	701	535	422	309	226	169	131	103	82	67	55	46	39

LEGENDA / INDEX

Appoggio esterno 100 mm; appoggio interno 100 mm / End support 100 mm; internal support 100 mm

Valori carico ammissibile uniformemente distribuito per la condizione di Stato Limite Ultimo (SLU) della lamiera

Per la condizione di Stato Limite di Esercizio (SLE) della lamiera ($F \leq L/200$) / Serviceability limit of the corrugated sheet (SLE) ($F \leq L/200$)

I rapporti di prova pubblicati in questo catalogo vengono forniti a titolo puramente indicativo. I dati pubblicati sono stati calcolati secondo le Norme vigenti: NTC2018, Circolare esplicativa alle NTC2018, UNI EN 1993 (EC3). Per una corretta applicazione del prodotto sarà onere e cura del cliente e/o del progettista la redazione di calcoli appropriati con specifico riferimento al singolo impiego.

The test reports published in this catalogue are provided for indicative purposes only. The published data have been calculated according to the current regulations: NTC2018, Explanatory circular to NTC2018, UNI EN 1993 (EC3). For a correct application of the product, it will be responsibility and care of the customer and/or the designer to draw up appropriate calculations with specific reference to the individual use.

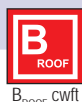

CLASSE / CLASS



Silma 8 è un profilo dalle eccellenti performance: adattabile anche nei rivestimenti interni e nei controsoffitti grazie alla conformazione del suo design, si distingue per l'elevata portata, la piacevolezza delle forme e il caratteristico piedino d'appoggio della linea Silma.

Silma 8 is a profile with excellent performance: it can also be adapted to interior coverings and false ceilings thanks to the conformation of its design, it stands out for its high load-bearing capacity, pleasant shapes and the characteristic support foot of the Silma line.



CURVATURA CON TACCHETTATURA
NOTCHING CURVED METAL SHEET

Per maggiori informazioni vedi pagine da 36 a 39.
For more information see pages 36 to 39.

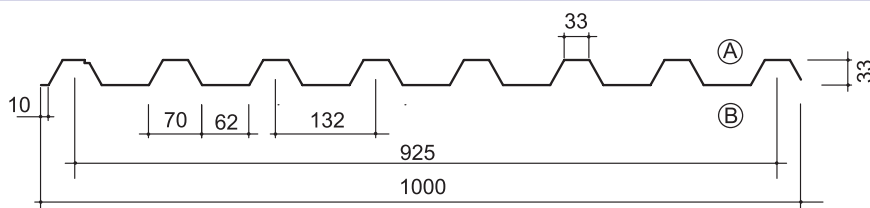

Nei disegni, A o B indicano il lato preverniciato desiderato.
In the drawings A or B show the wished prepainted side.

Nome del prodotto Product name	Numero greche Number of ribs (nr)	Interasse greche Pitch (mm)	Altezza greca Rib height (mm)	Larghezza greca Rib width (mm)	Base greca Rib long base (mm)	Larghezza modulo Covering width (mm)	Numero greche di sormonto Rib overlap (nr)
SILMA 8	8	132	33	33	70	925	1

COMPORTAMENTO AL FUOCO / FIRE REACTION	
Reazione al fuoco / Fire reaction class	A1 - UNI EN 13501-1
Comportamento al fuoco dall'esterno / External fire performance	Broof - UNI EN 13501-5 - CWFT - UNI ENV 1187

Caratteristiche tecniche - Datasheet

Dimensioni: larghezza 925 (mm), lunghezza a richiesta da produzione in continuo.

Spessori: fino a mm 1,0 - anche non standard su richiesta.

Supporti: acciaio zincato preverniciato o plastificato; Aluzinc; acciaio inox; alluminio naturale, preverniciato o gofrato.

Trattamenti protettivi applicabili a richiesta: Preverniciatura con poliester, superpoliester (hd), pvdf, poliuretani pur/pa, con spessori compresi tra 15 µm a 55 µm. Disponibilità su richiesta di altri film e rivestimenti.

Dimensions: width 925 (mm), length upon request from continuous production process.

Thicknesses (S): up to mm 1,0 - also non-standard on request.

Supports: prepainted or plasticized galvanized steel; Aluzinc; stainless steel; natural, prepainted or embossed aluminum.

Protective treatments for external support available on request: Pre-painting with polyester, superpolyester (hd), pvdf, polyurethane pur/pa, with thicknesses ranging from 15 µm to 55 µm. Availability on request of other films and coatings.

SILMA 8 - ACCIAIO / STEEL - CARATTERISTICHE STATICHE / STATIC CHARACTERISTICS

spessore lamiera - sheet metal thickness	Peso weight (passo) 925 mm	PROPRIETA' DI MASSA EFFICACI: - EFFECTIVE MASS PROPERTIES:															
		PROPRIETA' DI MASSA LORDE: GROSS MASS PROPERTY:				MOMENTO POSITIVO IN CAMPATA POSITIVE MOMENT ON SPAN								MOMENTO NEGATIVO SULL'APPOGGIO NEGATIVE MOMENT ON SUPPORT			
		A	J _{xG}	W _{e sup}	W _{e inf}	A _{eff}	J _{xG eff}	W _{e sup eff}	W _{e inf eff}	A _{eff}	J _{xG eff}	W _{e sup eff}	W _{e inf eff}				
		cm ² /m	cm ⁴ /m	cm ³ /m	cm ³ /m	cm ² /m	cm ⁴ /m	cm ³ /m	cm ³ /m	cm ² /m	cm ⁴ /m	cm ³ /m	cm ³ /m				
0,5	5,3	6,465	11,892	6,160	8,682	6,066	10,309	5,011	8,295	5,057	8,516	5,497	4,864				
0,6	6,3	7,757	14,271	7,393	10,420	7,429	12,991	6,444	10,116	6,265	10,804	6,735	6,371				
0,7	7,4	9,050	16,651	8,626	12,157	8,819	15,767	7,959	11,953	7,527	13,215	7,993	8,024				
0,8	8,4	10,343	19,031	9,859	13,895	10,229	18,601	9,530	13,798	8,838	15,727	9,267	9,812				
1,0	10,5	12,929	23,795	12,327	17,373	12,929	23,795	12,327	17,373	11,589	20,989	11,845	13,736				



I valori di portata in tabella non includono il peso proprio della lamiera grecata.
The capacity load shown in the table does not include the weight of the metal sheet itself.

SILMA 8: ACCIAIO / STEEL

Per i materiali ALUZINC e ACCIAIO INOX fare riferimento a questa tabella / Refer to these tables for data on Aluzinc and stainless steel materials

PORTATA DEL PROFILO IN daN/m² CON FRECCIA ≤ L/200 SU UNA CAMPATA / SHEET CAPACITY, daN /m² WITH DEFLECTION <L/200 OF A SPAN

Spessore / thickness	 Distanza tra gli appoggi "L" in metri / Pitch "L" in metres between the supports															
	mm	1,00	1,25	1,50	1,75	2,00	2,25	2,50	2,75	3,00	3,25	3,50	3,75	4,00	4,25	4,50
0,50	695	445	309	227	174	137	111	92	77	66	57	49	43	38	34	
	695	434	251	158	106	74	54	41	31	25	20	16	-	-	-	
0,60	1050	677	470	345	264	209	169	140	118	100	86	75	66	59	52	
	1050	601	348	219	147	103	75	56	43	34	27	22	18	-	-	
0,70	1240	794	551	405	310	245	198	164	138	117	101	88	78	69	61	
	1240	701	406	255	171	120	88	66	51	40	32	26	21	-	-	
0,80	1425	912	633	465	356	281	228	188	158	135	116	101	89	79	70	
	1425	801	464	292	196	137	100	75	58	46	36	30	24	20	-	
0,90	1611	1031	716	526	403	318	258	213	179	153	132	115	101	89	80	
	1611	901	522	328	220	155	113	85	65	51	41	33	28	23	-	
1,00	1799	1152	800	588	450	355	288	238	200	170	147	128	112	100	89	
	1799	1001	580	365	244	172	125	94	72	57	46	37	31	25	21	

PORTATA DEL PROFILO IN daN/m² CON FRECCIA ≤ L/200 SU UNA CAMPATA / SHEET CAPACITY, daN /m² WITH DEFLECTION <L/200 OF A SPAN

Spessore / thickness	 Distanza tra gli appoggi "L" in metri / Pitch "L" in metres between the supports															
	mm	1,00	1,25	1,50	1,75	2,00	2,25	2,50	2,75	3,00	3,25	3,50	3,75	4,00	4,25	4,50
0,50	725	503	371	284	225	183	152	126	106	90	78	68	60	53	47	
	725	503	371	284	203	142	104	78	60	47	38	31	25	-	-	
0,60	1007	699	514	395	313	254	210	175	147	125	108	94	83	73	65	
	1007	699	514	395	281	197	144	108	83	65	52	43	35	29	25	
0,70	1230	849	622	476	376	305	248	205	172	147	127	110	97	86	77	
	1230	849	622	476	328	230	168	126	97	76	61	50	41	34	-	
0,80	1460	1003	733	559	441	352	285	235	198	169	145	127	111	99	88	
	1460	1003	733	559	374	263	192	144	111	87	70	57	47	39	33	
0,90	1696	1161	846	644	503	398	322	266	224	191	164	143	126	111	99	
	1696	1161	846	629	421	296	216	162	125	98	79	64	53	44	37	
1,00	1939	1323	961	730	562	444	360	297	250	213	184	160	141	125	111	
	1939	1323	961	699	468	329	240	180	139	109	87	71	59	49	41	

LEGENDA / INDEX

Appoggio esterno 100 mm; appoggio interno 100 mm / End support 100 mm; internal support 100 mm

Valori carico ammissibile uniformemente distribuito per la condizione di Stato Limite Ultimo (SLU) della lamiera

Per la condizione di Stato Limite di Esercizio (SLE) della lamiera ($F \leq L/200$) / Serviceability limit of the corrugated sheet (SLE) ($F \leq L/200$)

I rapporti di prova pubblicati in questo catalogo vengono forniti a titolo puramente indicativo. I dati pubblicati sono stati calcolati secondo le Norme vigenti: NTC2018, Circolare esplicativa alle NTC2018, UNI EN 1993 (EC3). Per una corretta applicazione del prodotto sarà onere e cura del cliente e/o del progettista la redazione di calcoli appropriati con specifico riferimento al singolo impiego.

The test reports published in this catalogue are provided for indicative purposes only. The published data have been calculated according to the current regulations: NTC2018, Explanatory circular to NTC2018, UNI EN 1993 (EC3). For a correct application of the product, it will be responsibility and care of the customer and/or the designer to draw up appropriate calculations with specific reference to the individual use.

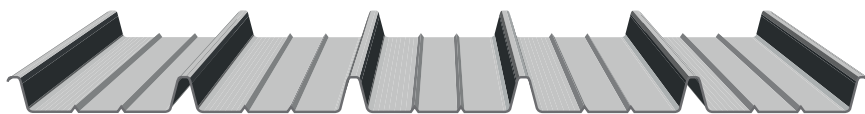

Un prodotto storico della gamma Isolpack, apprezzato da professionisti ed installatori e impiegato per coperture industriali.

A historic product from the Isolpack range, appreciated by professionals and installers and used for industrial roofing.

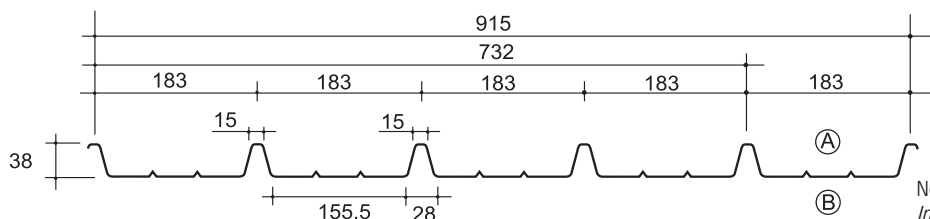

Nei disegni, A o B indicano il lato preverniciato desiderato. In the drawings A or B show the wished prepainted side.

Nome del prodotto Product name	Numero greche Number of ribs (nr)	Interasse greche Pitch (mm)	Altezza greca Rib height (mm)	Larghezza greca Rib width (mm)	Base greca Rib long base (mm)	Larghezza modulo Covering width (mm)	Numero greche di sormonto Rib overlap (nr)
CT/C 200	6	183	38	15	28	915	1

COMPORTAMENTO AL FUOCO / FIRE REACTION	
Reazione al fuoco / Fire reaction class	A1 - UNI EN 13501-1
Comportamento al fuoco dall'esterno / External fire performance	Broof - UNI EN 13501-5 - CWFT - UNI ENV 1187

Caratteristiche tecniche - Datasheet

Dimensioni: larghezza 915 (mm), lunghezza a richiesta da produzione in continuo.

Spessori: fino a mm 1,0 - anche non standard su richiesta.

Supporti: acciaio zincato preverniciato o plastificato; Aluzinc; acciaio inox; alluminio naturale, preverniciato o gofrato.

Trattamenti protettivi applicabili a richiesta:

Preverniciatura con poliestere, superpoliestere (hd), pvdf, poliuretani pur/pa, con spessori compresi tra 15 µm a 55 µm. Disponibilità su richiesta di altri film e rivestimenti.

Dimensions: width 915 (mm), length upon request from continuous production process.

Thicknesses (S): up to mm 1,0 - also non-standard on request.

Supports: prepainted or plasticized galvanized steel; Aluzinc; stainless steel; natural, prepainted or embossed aluminum.



Protective treatments for external support available on request: Pre-painting with polyester, superpolyester (hd), pvdf, polyurethane pur/pa, with thicknesses ranging from 15 µm to 55 µm. Availability on request of other films and coatings.

CT/C 200 - ACCIAIO / STEEL - CARATTERISTICHE STATICHE / STATIC CHARACTERISTICS

spessore lamiera - sheet metal thickness	Peso weight (passo) 915 mm	PROPRIETA' DI MASSA EFFICACI: - EFFECTIVE MASS PROPERTIES:											
		PROPRIETA' DI MASSA LORDE: GROSS MASS PROPERTY:											
		MOMENTO POSITIVO IN CAMPATA POSITIVE MOMENT ON SPAN						MOMENTO NEGATIVO SULL'APPOGGIO NEGATIVE MOMENT ON SUPPORT					
		A	J _{xG}	W _{e sup}	W _{e inf}	A _{eff}	J _{xG eff}	W _{e sup eff}	W _{e inf eff}	A _{eff}	J _{xG eff}	W _{e sup eff}	W _{e inf eff}
[kg/m ²]	cm ² /m	cm ⁴ /m	cm ³ /m	cm ³ /m	cm ² /m	cm ⁴ /m	cm ³ /m	cm ³ /m	cm ² /m	cm ⁴ /m	cm ³ /m	cm ³ /m	
0,5	5,3	6,698	10,627	3,671	13,530	6,647	10,474	3,602	13,564	3,173	6,034	2,985	3,638
0,6	6,4	8,038	12,754	4,406	16,237	8,038	12,754	4,406	16,237	3,972	7,677	3,672	4,830
0,7	7,4	9,377	14,881	5,141	18,945	9,377	14,881	5,141	18,945	4,824	9,417	4,374	6,167
0,8	8,5	10,717	17,009	5,876	21,654	10,717	17,009	5,876	21,654	5,725	11,241	5,087	7,645
1,0	10,6	13,396	21,267	7,347	27,075	13,396	21,267	7,347	27,075	7,674	15,099	6,540	11,011



I valori di portata in tabella non includono il peso proprio della lamiera grecata.
The capacity load shown in the table does not include the weight of the metal sheet itself.

CT/C 200: ACCIAIO / STEEL															
Per i materiali ALUZINC e ACCIAIO INOX fare riferimento a questa tabella / Refer to these tables for data on Aluzinc and stainless steel materials															
PORTATA DEL PROFILO IN daN/m ² CON FRECCIA ≤ L/200 SU UNA CAMPATA / SHEET CAPACITY, daN /m ² WITH DEFLECTION <L/200 OF A SPAN															
Spessore / thickness															
	Distanza tra gli appoggi "L" in metri / Pitch "L" in metres between the supports														
mm	1,00	1,25	1,50	1,75	2,00	2,25	2,50	2,75	3,00	3,25	3,50	3,75	4,00	4,25	4,50
0,50	500	320	222	163	125	99	80	66	56	47	41	36	31	28	25
	500	320	222	161	108	76	55	41	32	25	20	16	-	-	-
0,60	611	391	272	200	153	121	98	81	68	58	50	43	38	34	30
	611	391	272	196	131	92	67	50	39	31	24	20	16	-	-
0,70	713	456	317	233	178	141	114	94	79	68	58	51	45	39	35
	713	456	317	228	153	107	78	59	45	36	29	23	19	-	-
0,80	815	522	362	266	204	161	130	108	91	77	67	58	51	45	40
	815	522	362	261	175	123	89	67	52	41	33	27	22	18	-
0,90	917	587	408	299	229	181	147	121	102	87	75	65	57	51	45
	917	587	408	294	197	138	101	76	58	46	37	30	25	20	17
1,00	1019	652	453	333	255	201	163	135	113	96	83	72	64	56	50
	1019	652	453	326	219	153	112	84	65	51	41	33	27	23	19
PORTATA DEL PROFILO IN daN/m ² CON FRECCIA ≤ L/200 SU UNA CAMPATA / SHEET CAPACITY, daN /m ² WITH DEFLECTION <L/200 OF A SPAN															
Spessore / thickness															
	Distanza tra gli appoggi "L" in metri / Pitch "L" in metres between the supports														
mm	1,00	1,25	1,50	1,75	2,00	2,25	2,50	2,75	3,00	3,25	3,50	3,75	4,00	4,25	4,50
0,50	452	308	223	169	129	102	83	68	57	49	42	37	32	29	26
	452	308	223	169	129	102	83	68	57	48	38	31	26	21	-
0,60	573	389	281	208	159	126	102	84	71	60	52	45	40	35	31
	573	389	281	208	159	126	102	84	71	58	47	38	31	26	-
0,70	699	472	337	248	190	150	121	100	84	72	62	54	47	42	37
	699	472	337	248	190	150	121	100	84	68	55	44	37	31	-
0,80	830	559	392	288	220	174	141	117	98	83	72	63	55	49	44
	830	559	392	288	220	174	141	117	98	78	62	51	42	35	29
0,90	964	645	448	329	252	199	161	133	112	95	82	72	63	56	50
	964	645	448	329	252	199	161	133	112	88	70	57	47	39	33
1,00	1100	726	504	370	283	224	181	150	126	107	93	81	71	63	56
	1100	726	504	370	283	224	181	150	124	98	78	63	52	44	37
LEGENDA / INDEX															
Appoggio esterno 100 mm; appoggio interno 100 mm / End support 100 mm; internal support 100 mm															
Per la condizione di Stato Limite Ultimo (SLU) della lamiera / <i>Ultimate limit-state design of the corrugated sheet (SLU)</i>															
Per la condizione di Stato Limite di Esercizio (SLE) della lamiera (F ≤ L/200) / <i>Serviceability limit of the corrugated sheet (SLE) (F ≤ L/200)</i>															

I rapporti di prova pubblicati in questo catalogo vengono forniti a titolo puramente indicativo. I dati pubblicati sono stati calcolati secondo le Norme vigenti: NTC2018, Circolare esplicativa alle NTC2018, UNI EN 1993 (EC3). Per una corretta applicazione del prodotto sarà onere e cura del cliente e/o del progettista la redazione di calcoli appropriati con specifico riferimento al singolo impiego.

The test reports published in this catalogue are provided for indicative purposes only. The published data have been calculated according to the current regulations: NTC2018, Explanatory circular to NTC2018, UNI EN 1993 (EC3). For a correct application of the product, it will be responsibility and care of the customer and/or the designer to draw up appropriate calculations with specific reference to the individual use.



Un profilo con una greca di altezza media, impiegato principalmente per coperture industriali.

A profile with a rib of medium height, mainly used for industrial roofing.

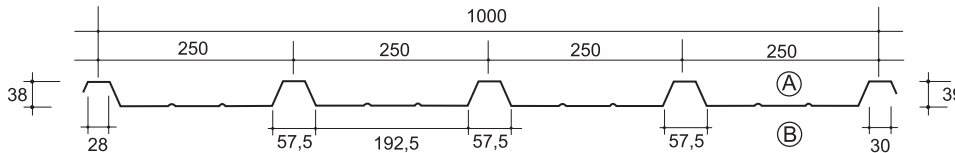

Nei disegni, A o B indicano il lato preverniciato desiderato.
In the drawings A or B show the wished prepainted side.

Nome del prodotto Product name	Numero greche Number of ribs (nr)	Interasse greche Pitch (mm)	Altezza greca Rib height (mm)	Larghezza greca Rib width (mm)	Base greca Rib long base (mm)	Larghezza modulo Covering width (mm)	Numero greche di sormonto Rib overlap (nr)
LG 40 /1000	5	250	39	30	57,5	1000	1

COMPORTAMENTO AL FUOCO / FIRE REACTION	
Reazione al fuoco / Fire reaction class	A1 - UNI EN 13501-1
Comportamento al fuoco dall'esterno / External fire performance	Broof - UNI EN 13501-5 - CWFT - UNI ENV 1187

Caratteristiche tecniche - Datasheet

Dimensioni: larghezza 1000 (mm), lunghezza a richiesta da produzione in continuo.

Spessori: fino a mm 1,0 - anche non standard su richiesta.

Supporti: acciaio zincato preverniciato o plastificato; Aluzinc; acciaio inox; alluminio naturale, preverniciato o gofrato.

Trattamenti protettivi applicabili a richiesta: Preverniciatura con poliestere, superpoliestere (hd), pvdf, poliuretani pur/pa, con spessori compresi tra 15 µm a 55 µm. Disponibilità su richiesta di altri film e rivestimenti.

Dimensions: width 1000 (mm), length upon request from continuous production process.

Thicknesses (S): up to mm 1,0 - also non-standard on request.

Supports: prepainted or plasticized galvanized steel; Aluzinc; stainless steel; natural, prepainted or embossed aluminum.

Protective treatments for external support available on request: Pre-painting with polyester, superpolyester (hd), pvdf, polyurethane pur/pa, with thicknesses ranging from 15 µm to 55 µm. Availability on request of other films and coatings.

LG 40/1000 - ACCIAIO / STEEL - CARATTERISTICHE STATICHE / STATIC CHARACTERISTICS



spessore lamiera - sheet metal thickness	Peso weight	PROPRIETA' DI MASSA EFFICACI: - EFFECTIVE MASS PROPERTIES:															
		PROPRIETA' DI MASSA LORDE: GROSS MASS PROPERTY:				MOMENTO POSITIVO IN CAMPATA POSITIVE MOMENT ON SPAN								MOMENTO NEGATIVO SULL'APPOGGIO NEGATIVE MOMENT ON SUPPORT			
		A	J _{xG}	W _{e sup}	W _{e inf}	A _{eff}	J _{xG eff}	W _{e sup eff}	W _{e inf eff}	A _{eff}	J _{xG eff}	W _{e sup eff}	W _{e inf eff}				
		[kg/m ²]	cm ² /m	cm ⁴ /m	cm ³ /m	cm ² /m	cm ⁴ /m	cm ³ /m	cm ³ /m	cm ² /m	cm ⁴ /m	cm ³ /m	cm ³ /m				
0,5	4,8	6,560	16,766	14,612	6,091	3,243	7,934	3,419	5,024	5,822	10,964	13,439	3,555				
0,6	5,8	7,872	20,120	17,536	7,310	4,015	10,164	4,518	6,158	7,185	14,415	16,305	4,780				
0,7	6,8	9,184	23,475	20,459	8,528	4,826	12,554	5,749	7,314	8,494	17,824	19,293	5,989				
0,8	7,8	10,496	26,831	23,384	9,748	5,675	15,088	7,110	8,487	9,828	21,427	22,311	7,289				
1,0	9,7	13,120	33,544	29,235	12,186	7,484	20,532	10,208	10,872	12,559	29,101	28,408	10,120				



I valori di portata in tabella non includono il peso proprio della lamiera greccata.
The capacity load shown in the table does not include the weight of the metal sheet itself.

LG 40/1000: ACCIAIO / STEEL

Per i materiali ALUZINC e ACCIAIO INOX fare riferimento a questa tabella / Refer to these tables for data on Aluzinc and stainless steel materials

PORTATA DEL PROFILO IN daN/m ² CON FRECCIA ≤ L/200 SU UNA CAMPATA / SHEET CAPACITY, daN /m ² WITH DEFLECTION <L/200 OF A SPAN															
Spessore / thickness															
	Distanza tra gli appoggi "L" in metri / Pitch "L" in metres between the supports														
mm	1,00	1,25	1,50	1,75	2,00	2,25	2,50	2,75	3,00	3,25	3,50	3,75	4,00	4,25	4,50
0,50	464	371	310	228	174	138	111	92	77	66	57	50	44	39	34
	464	334	193	122	82	57	42	31	24	19	15	12	-	-	-
0,60	650	520	380	279	214	169	137	113	95	81	70	61	53	47	42
	650	428	248	156	104	73	53	40	31	24	19	16	13	-	-
0,70	864	649	451	331	254	200	162	134	113	96	83	72	63	56	50
	864	528	306	193	129	91	66	50	38	30	24	20	-	-	-
0,80	1105	753	523	384	294	233	188	156	131	111	96	84	74	65	58
	1105	635	367	231	155	109	79	60	46	36	29	24	19	-	-
0,90	650	520	380	279	214	169	137	113	95	81	70	61	53	47	42
	650	428	248	156	104	73	53	40	31	24	19	16	13	-	-
1,00	1508	965	670	492	377	298	241	199	168	143	123	107	94	83	74
	1508	864	500	315	211	148	108	81	63	49	39	32	26	22	19
PORTATA DEL PROFILO IN daN/m ² CON FRECCIA ≤ L/200 SU UNA CAMPATA / SHEET CAPACITY, daN /m ² WITH DEFLECTION <L/200 OF A SPAN															
Spessore / thickness															
	Distanza tra gli appoggi "L" in metri / Pitch "L" in metres between the supports														
mm	1,00	1,25	1,50	1,75	2,00	2,25	2,50	2,75	3,00	3,25	3,50	3,75	4,00	4,25	4,50
0,50	464	322	238	183	145	118	97	81	68	58	50	44	39	34	30
	464	322	238	183	145	110	80	60	46	36	29	24	20	-	-
0,60	628	436	321	247	195	159	132	110	92	78	68	59	52	46	41
	628	436	321	247	195	140	102	77	59	47	37	30	25	21	-
0,70	799	554	407	312	247	201	166	137	115	98	85	74	65	57	51
	799	554	407	312	247	173	126	95	73	58	46	37	31	26	-
0,80	984	681	500	383	303	246	202	167	140	120	103	90	79	70	62
	984	681	500	383	297	209	152	114	88	69	55	45	37	31	26
0,90	628	436	321	247	195	159	132	110	92	78	68	59	52	46	41
	628	436	321	247	195	140	102	77	59	47	37	30	25	21	18
1,00	1394	962	705	539	426	345	281	232	195	166	143	125	110	97	87
	1394	962	705	539	404	284	207	155	120	94	75	61	50	42	35
LEGENDA / INDEX															
Appoggio esterno 100 mm; appoggio interno 100 mm / End support 100 mm; internal support 100 mm															
Per la condizione di Stato Limite Ultimo (SLU) della lamiera / <i>Ultimate limit-state design of the corrugated sheet (SLU)</i>															
Per la condizione di Stato Limite di Esercizio (SLE) della lamiera (F ≤ L/200) / <i>Serviceability limit of the corrugated sheet (SLE) (F ≤ L/200)</i>															

I rapporti di prova pubblicati in questo catalogo vengono forniti a titolo puramente indicativo. I dati pubblicati sono stati calcolati secondo le Norme vigenti: NTC2018, Circolare esplicativa alle NTC2018, UNI EN 1993 (EC3). Per una corretta applicazione del prodotto sarà onere e cura del cliente e/o del progettista la redazione di calcoli appropriati con specifico riferimento al singolo impiego.

The test reports published in this catalogue are provided for indicative purposes only. The published data have been calculated according to the current regulations: NTC2018, Explanatory circular to NTC2018, UNI EN 1993 (EC3). For a correct application of the product, it will be responsibility and care of the customer and/or the designer to draw up appropriate calculations with specific reference to the individual use.



CLASSE / CLASS

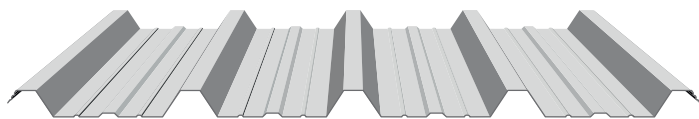

La lamiera dal passo 1000 che concilia elevate proprietà statiche e peso ridotto. L'accurato design e la massima funzionalità, la facilità e la rapidità di montaggio e la greca da 40 mm, fanno di questo sistema uno dei più utilizzati della gamma.

The sheet metal with a pitch of 1000 which combines high static properties and low weight. Accurate design and maximum functionality, ease and speed of assembly and the 40 mm rib makes this system one of the most used in the range.



CURVATURA CON TACCHETTATURA
NOTCHING CURVED METAL SHEET



CURVATURA CON CALANDRATURA
CALENDERED CURVED SHEET

Per maggiori informazioni vedi pagine da 36 a 39.
For more information see pages 36 to 39.

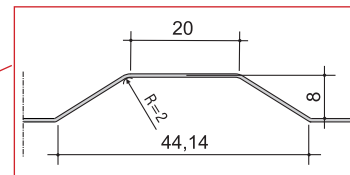
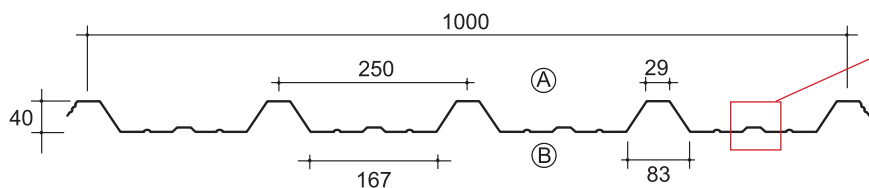

Nei disegni, A o B indicano il lato preverniciato desiderato.
In the drawings A or B show the wished prepainted side.

Nome del prodotto Product name	Numero greche Number of ribs (nr)	Interasse greche Pitch (mm)	Altezza greca Rib height (mm)	Larghezza greca Rib width (mm)	Base greca Rib long base (mm)	Larghezza modulo Covering width (mm)	Numero greche di sormonto Rib overlap (nr)
R/W 1000	5	250	40	29	83	1000	1

COMPORTAMENTO AL FUOCO / FIRE REACTION	
Reazione al fuoco / Fire reaction class	A1 - UNI EN 13501-1
Comportamento al fuoco dall'esterno / External fire performance	Broof - UNI EN 13501-5 - CWFT - UNI ENV 1187

Caratteristiche tecniche - Datasheet

Dimensioni: larghezza 1000 (mm), lunghezza a richiesta da produzione in continuo.

Spessori: fino a mm 1,0 - anche non standard su richiesta.

Supporti: acciaio zincato preverniciato o plastificato; Aluzinc; acciaio inox; alluminio naturale, preverniciato o goffrato.

Trattamenti protettivi applicabili a richiesta: Preverniciatura con poliestere, superpoliestere (hd), pvdf, poliuretani pur/pa, con spessori compresi tra 15 µm a 55 µm. Disponibilità su richiesta di altri film e rivestimenti.

Dimensions: width 1000 (mm), length upon request from continuous production process.

Thicknesses (S): up to mm 1,0 - also non-standard on request.

Supports: prepainted or plasticized galvanized steel; Aluzinc; stainless steel; natural, prepainted or embossed aluminum.

Protective treatments for external support available on request: Pre-painting with polyester, superpolyester (hd), pvdf, polyurethane pur/pa, with thicknesses ranging from 15 µm to 55 µm. Availability on request of other films and coatings.

R/W 1000 - ACCIAIO / STEEL - CARATTERISTICHE STATICHE / STATIC CHARACTERISTICS

spessore lamiera - sheet metal thickness	Peso weight	PROPRIETA' DI MASSA EFFICACI: - EFFECTIVE MASS PROPERTIES:															
		PROPRIETA' DI MASSA LORDE: GROSS MASS PROPERTY:				MOMENTO POSITIVO IN CAMPATA POSITIVE MOMENT ON SPAN								MOMENTO NEGATIVO SULL'APPOGGIO NEGATIVE MOMENT ON SUPPORT			
		A	J _{xG}	W _{e sup}	W _{e inf}	A _{eff}	J _{xG eff}	W _{e sup eff}	W _{e inf eff}	A _{eff}	J _{xG eff}	W _{e sup eff}	W _{e inf eff}				
[kg/m ²]	cm ² /m	cm ⁴ /m	cm ³ /m	cm ³ /m	cm ² /m	cm ⁴ /m	cm ³ /m	cm ³ /m	cm ² /m	cm ⁴ /m	cm ³ /m	cm ³ /m					
0,5	4,8	5,914	11,648	4,162	10,576	5,515	9,770	3,319	10,221	4,364	9,174	3,799	6,176				
0,6	5,8	7,097	13,979	4,995	12,692	6,958	13,066	4,587	12,421	5,546	11,572	4,646	8,211				
0,7	6,8	8,279	16,310	5,828	14,808	8,231	15,930	5,659	14,682	6,700	13,942	5,491	10,243				
0,8	7,8	9,462	18,642	6,661	16,925	9,462	18,642	6,661	16,925	7,905	16,380	6,345	12,425				
1,0	9,7	11,828	23,307	8,328	21,161	11,828	23,307	8,328	21,161	10,450	21,414	8,070	17,177				



I valori di portata in tabella non includono il peso proprio della lamiera greccata.
The capacity load shown in the table does not include the weight of the metal sheet itself.

R/W 1000: ACCIAIO / STEEL

Per i materiali ALUZINC e ACCIAIO INOX fare riferimento a questa tabella / Refer to these tables for data on Aluzinc and stainless steel materials

PORTATA DEL PROFILO IN daN/m² CON FRECCIA ≤ L/200 SU UNA CAMPATA / SHEET CAPACITY, daN /m² WITH DEFLECTION <L/200 OF A SPAN

Spessore / thickness															
	Distanza tra gli appoggi "L" in metri / Pitch "L" in metres between the supports														
mm	1,00	1,25	1,50	1,75	2,00	2,25	2,50	2,75	3,00	3,25	3,50	3,75	4,00	4,25	4,50
0,50	379	295	205	150	115	91	74	61	51	44	38	33	29	25	23
0,60	531	407	283	208	159	126	102	84	71	60	52	45	40	35	31
0,70	705	502	349	256	196	155	126	104	87	74	64	56	49	43	39
0,80	902	591	411	302	231	182	148	122	103	87	75	66	58	51	46
0,90	1039	665	462	339	260	205	166	137	115	98	85	74	65	58	51
1,00	1155	739	513	377	289	228	185	153	128	109	94	82	72	64	57

PORTATA DEL PROFILO IN daN/m² CON FRECCIA ≤ L/200 SU UNA CAMPATA / SHEET CAPACITY, daN /m² WITH DEFLECTION <L/200 OF A SPAN

Spessore / thickness															
	Distanza tra gli appoggi "L" in metri / Pitch "L" in metres between the supports														
mm	1,00	1,25	1,50	1,75	2,00	2,25	2,50	2,75	3,00	3,25	3,50	3,75	4,00	4,25	4,50
0,50	441	311	232	180	144	117	98	83	71	62	54	47	41	36	33
0,60	568	398	295	228	182	148	123	104	89	76	66	57	50	45	40
0,70	700	488	360	277	220	179	149	125	106	90	78	68	59	53	47
0,80	836	581	427	328	260	211	175	145	122	104	90	78	69	61	54
0,90	977	676	496	380	300	244	200	165	139	118	102	89	78	69	62
1,00	1122	773	566	433	342	276	224	185	155	132	114	99	87	77	69

LEGENDA / INDEX

Appoggio esterno 100 mm; appoggio interno 100 mm / End support 100 mm; internal support 100 mm

Per la condizione di Stato Limite Ultimo (SLU) della lamiera / *Ultimate limit-state design of the corrugated sheet (SLU)*

Per la condizione di Stato Limite di Esercizio (SLE) della lamiera ($F \leq L/200$) / *Serviceability limit of the corrugated sheet (SLE) ($F \leq L/200$)*

I rapporti di prova pubblicati in questo catalogo vengono forniti a titolo puramente indicativo. I dati pubblicati sono stati calcolati secondo le Norme vigenti: NTC2018, Circolare esplicativa alle NTC2018, UNI EN 1993 (EC3). Per una corretta applicazione del prodotto sarà onere e cura del cliente e/o del progettista la redazione di calcoli appropriati con specifico riferimento al singolo impiego.

The test reports published in this catalogue are provided for indicative purposes only. The published data have been calculated according to the current regulations: NTC2018, Explanatory circular to NTC2018, UNI EN 1993 (EC3). For a correct application of the product, it will be responsibility and care of the customer and/or the designer to draw up appropriate calculations with specific reference to the individual use.

CURVATURA CON TACCHETTATURA LUNGHEZZA LASTRE / SHEET LENGTH (MM) MIN. 1500 MAX. 6500*

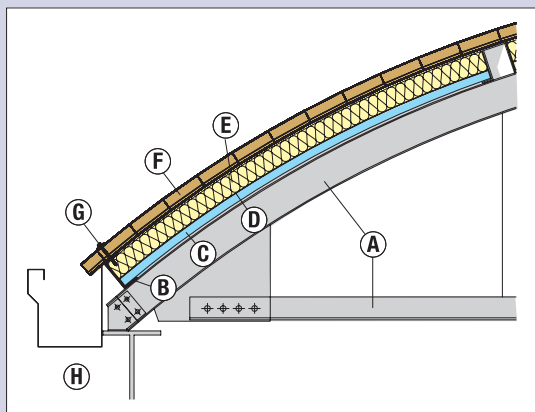

LEGENDA / INDEX	
Rif. / Ref.	Descrizione / Description
A	Struttura in acciaio / Steel structure
B	Arcarecci / Purlin roofs
C	Lastra di controsoffitto / Ceiling slab
D	Barriera al vapore / Vapour barrier
E	Coibentazione / Insulation
F	Lastra di copertura / Cover slab
G	Fissaggio per ferro / Metal roof fixing
H	Gronda / Guttering

TABELLA LAMIERA CURVA A TACCHETTATURA / NOTCHING CURVED METAL SHEET TABLE

R= raggio / radius (mm)	Lt= lunghezza lastra / sheet length (mm)
2000-13000	1000-1500
2500-13000	1500-3500
3000-13000	1500-4000
4000-13000	1500-5000
6000-13000	1500-6000
8000-13000	1500-6500

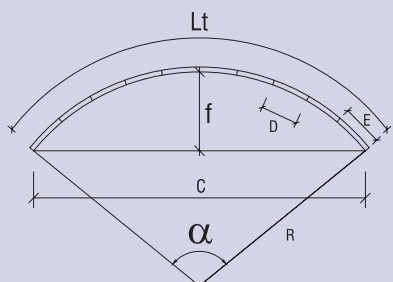

LEGENDA / INDEX	
$R = \frac{C^2 + 4F^2}{8F}$	C= CORDA / CHORD
	F= FRECCIA / RISE
	Lt= LUNGHEZZA ARCO / ARC LENGTH
$Lt = \frac{\pi \cdot R \cdot \alpha}{180}$	R= RAGGIO / RADIUS
	alpha = ANGOLO / ANGLE
	D= DISTANZA TACCHE / DISTANCE BETWEEN NOTCHES

MODELLI / MODELS		SILMA 6	SILMA 8	H28	H20	EUROSILMA	R/W 1000	SL 940
LUNGHEZZA / LENGTH	mm	min. 1500 max 6500	min. 1500 max 6500	min. 1500 max 6500	min. 1500 max 6500	min. 1500 max 6500	min. 500 max 6500	min. 2000 max 6000
RAGGIO / RADIUS	mm	min. 2000	min. 2000	min. 2000	min. 2000	min. 2000	min. 250	min. 1000

*Le lunghezze extra sono realizzabili solo su specifica autorizzazione dell'azienda / Extra lengths can only be made upon the specific authorization of the company.

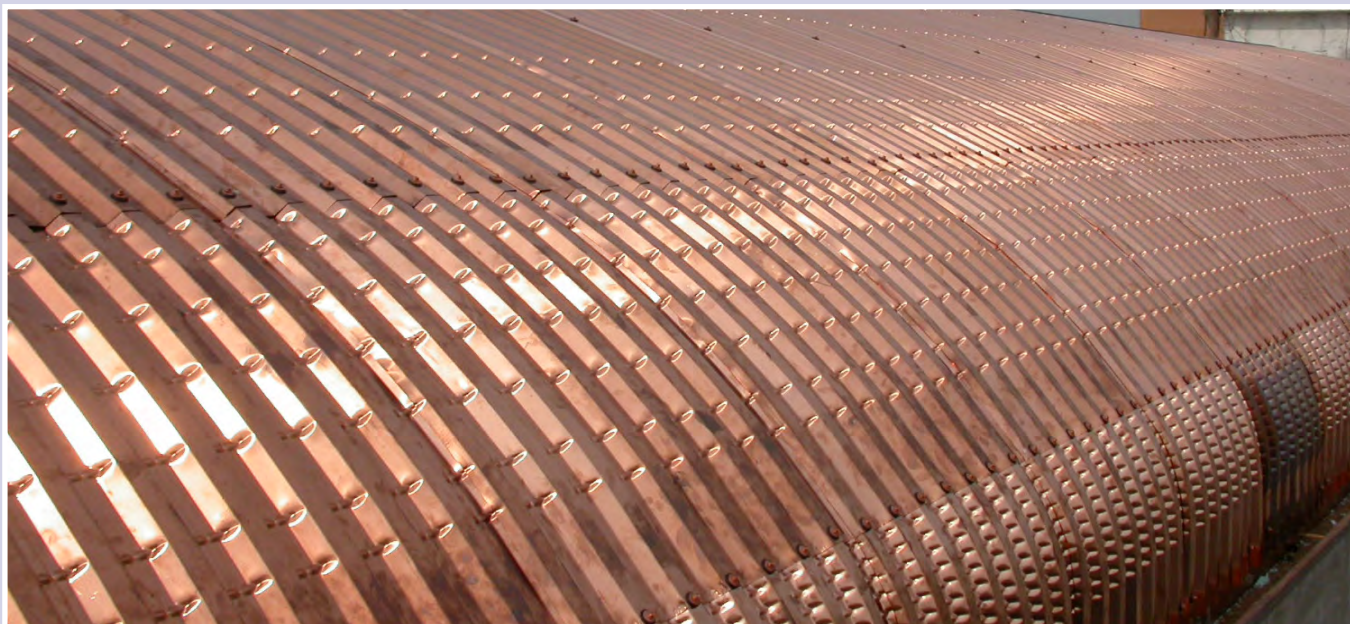

CURVATURA CON CALANDRATURA

LUNGHEZZA LASTRE / SHEET LENGTH (MM) MIN. 1500 MAX. 6500*

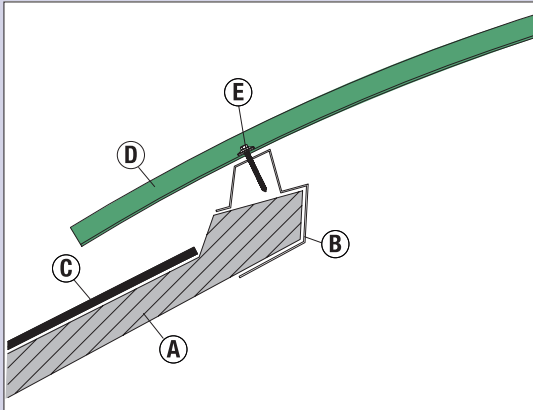

LEGENDA / INDEX	
Rif. / Ref.	Descrizione / Description
A	Tegolo in c.a.p. / Pre-stressed reinforced concrete tiles
B	Banchina metallica / Metal support
C	Guaina bituminosa / Bituminous membrane
D	Lastra di copertura / Cover slab
E	Fissaggio per ferro / Metal roof fixing

TABELLA LAMIERA CURVA CALANDRATA / CALENDERED CURVED SHEET TABLE					
R= raggio / radius (mm)		Lt= lunghezza arco / arc length (mm)		D= distanza tacche / distance between notches (mm)	E= Dist. 1a tacca da inizio lastra / Dist. of first notch from end of the sheet (mm)
Min	Max	Min	Max	(mm)	(mm)
2000	A richiesta / Upon request	1500	6500	50	40

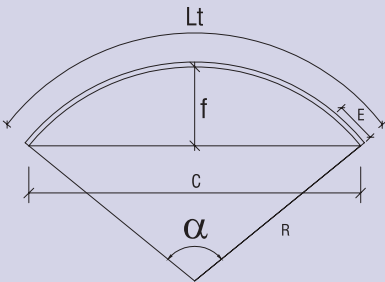

LEGENDA / INDEX	
$R = \frac{C^2 + 4F^2}{8F}$	C= CORDA / CHORD
	F= FRECCIA / RISE
	Lt= LUNGHEZZA ARCO / ARC LENGTH
$Lt = \frac{\pi \cdot R \cdot \alpha}{180}$	R= RAGGIO / RADIUS
	α= ANGOLO / ANGLE

MODELLI / MODELS		H28	R/W 1000
LUNGHEZZA / LENGTH	mm	min. 1500 max 6500	min. 1000 max 6000
RAGGIO / RADIUS	mm	min. 3000	min. 4500 (acciaio) / 5000 (alluminio)

*Le lunghezze extra sono realizzabili solo su specifica autorizzazione dell'azienda / Extra lengths can only be made upon the specific authorization of the company.



LASTRA DI COLMO CON LAVORAZIONE AD IMPRONTE / NOTCHING CURVED SHEET

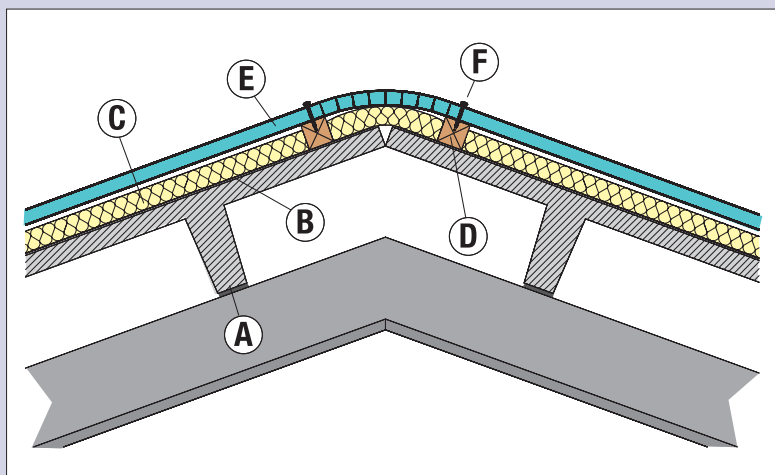

LEGENDA / INDEX	
Rif. / Ref.	Descrizione / Description
A	Tegolo in c.a. / Reinforced concrete beam
B	Barriera al vapore / Vapour barrier
C	Coibentazione / Insulation
D	Listello in legno / Wooden batten
E	Lastra di colmo / Ridge sheet
F	Fissaggio per legno / wood mount



TABELLA SEZIONE 2 / TABLE SECTION 2						
P = Pendenza / Pitch %		Lt = Lunghezza lastre standard / Standard length sheet (mm)		Lunghezza lastre extra / Extra length sheet (mm)	a-b (mm)	
Min	Max	Min	Max	Max	Min	Max
1	15	750	6500*	10000	300	Variab. / Variable
15	20	1000	7000*	7000		

MODELLI / MODELS		SILMA 6	SILMA 8	H28	H20	EUROSILMA
LUNGHEZZA / LENGTH	mm	min. 800 max 6500*	min. 800 max 6500*	min. 800 max 6500*	min. 800 max 6500*	min. 800 max 6500*

*Le lunghezze extra sono realizzabili solo su specifica autorizzazione dell'azienda / Extra lengths can only be made upon the specific authorization of the company.

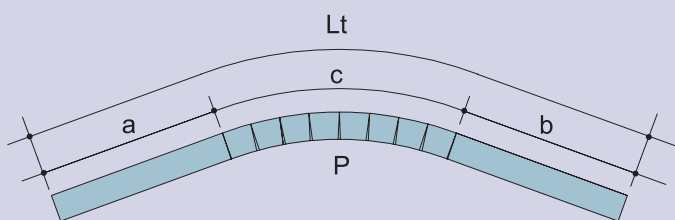
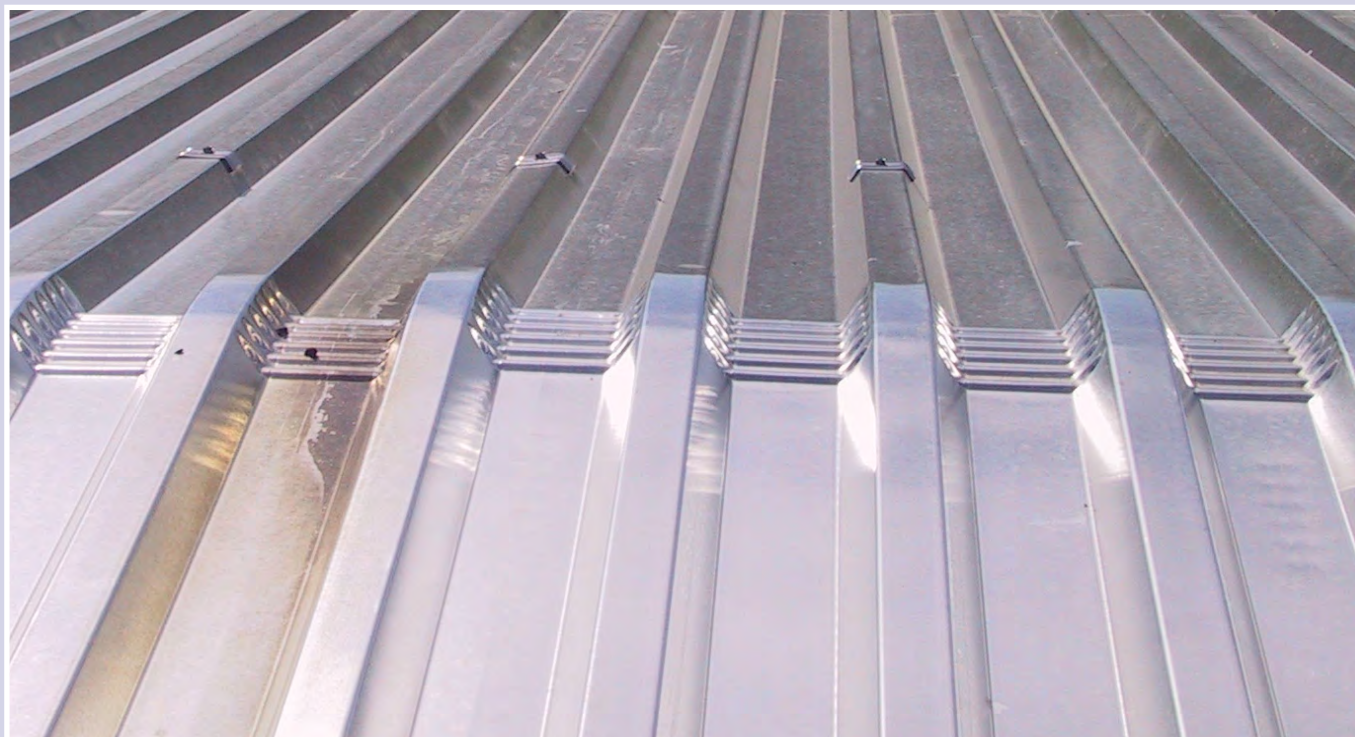

LAISTRA PIEGATA A SHED / SHED BENT SHEET

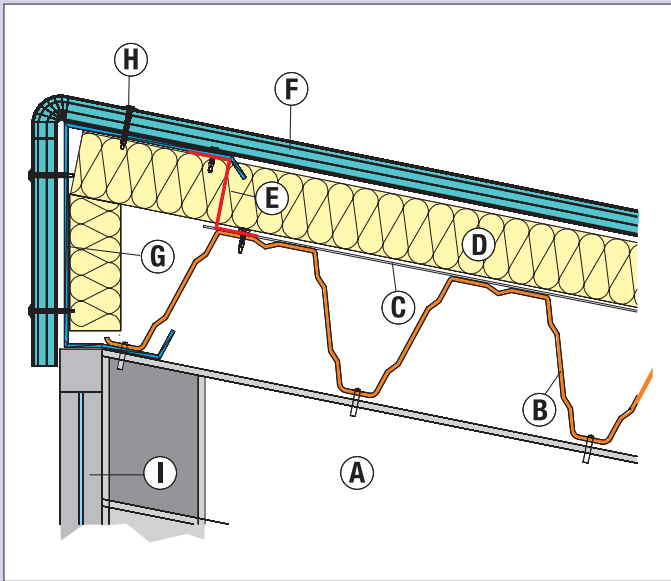

LEGENDA / INDEX	
Rif. / Ref.	Descrizione / Description
A	Struttura in acciaio / Steel structure
B	Tecnodec / Tecnodec
C	Barriera al vapore / Vapour barrier
D	Coibentazione / Insulation
E	Distanziatore a Z / Z spacer
F	Lastra piegata a shed / Shed bent sheet
G	Stampato di contenimento (sp. = 3 mm) / Containment die (thickness = 3 mm)
H	Fissaggio per ferro / mount screw for steel
I	Serramento a shed / Shed fitting



TABELLA TECNICA / TECHNICAL SHEET			
Modello / Model	$L_{\text{tot}} (L+H) =$ lunghezza lastra / sheet length (mm)		Spessore / Thickness (mm)
	Min	Max	
H28	1000	4000*	da 0,5 a 1,0 / from 0,5 up to 1,0*
			* max sp. Aluzinc e Acciaio Inox 0,8

*Le lunghezze extra sono realizzabili solo su specifica autorizzazione dell'azienda / Extra lengths can only be made upon the specific authorization of the company.

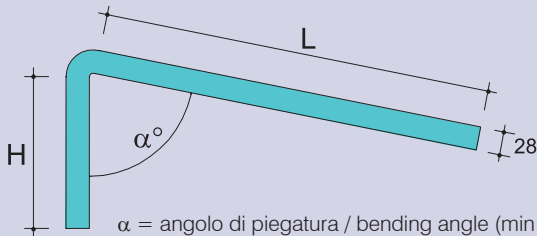

MODELLO / MODEL
SL940
SILMA 6
SILMA 8
EUROSILMA

(tab.A)

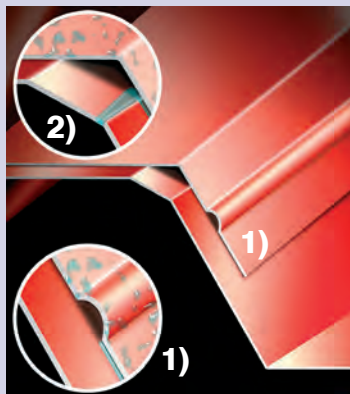

I canali di drenaggio garantiscono la doppia tenuta e scaricano l'acqua in gronda.

The drainage channels ensure double sealing and drain the water into the gutter.

I modelli che utilizzano questo tipo di sormonto laterale in copertura (vd tab.A), offrono un'ulteriore tenuta all'acqua. La tenuta maggiorata è data dalla particolare geometria del sormonto che garantisce due livelli di sicurezza anche in caso di condizioni climatiche severe.

Il funzionamento del sistema:

1) Il primo canale di drenaggio, posto sull'ala della greca, genera una brusca caduta di pressione nell'acqua in risalita per capillarità, facendo mancare la spinta necessaria per scavalcare il sormonto grecato.

2) nel caso in cui il primo canale di drenaggio non sia sufficiente a generare l'abbassamento necessario di pressione dell'acqua, interviene il secondo livello di sicurezza, posto in corrispondenza dello spigolo della greca. Il vano che si crea dal distacco tra le lamiere genera un ulteriore brusco abbassamento della pressione dell'acqua, e contemporaneamente funge da canale di scolo portando l'acqua in gronda.

Conclusioni: Questo sistema di sormonto è minimo ed efficace, riduce la superficie di sovrapposizione, consentendo nel contempo un notevole risparmio di materiale e di costi senza rinunciare alla tenuta alle infiltrazioni d'acqua.

The models that use this type of lateral overlap on the roof (see tab.A) offer additional water tightness. The increased tightness is given by the particular geometry of the overlap which guarantees two levels of safety even in the event of severe climatic conditions.

The functioning of the system:

1) The first drainage channel, located on the wing of the corrugation, generates a sudden drop in pressure in the rising water due to capillarity, lacking the necessary thrust to climb over the corrugated overlap.

2) in the event that the first drainage channel is not sufficient to generate the necessary lowering of water pressure, the second safety level intervenes, located at the edge of the corrugation. The compartment created by the detachment between the sheets generates a further abrupt lowering of the water pressure, and at the same time acts as a drainage channel bringing the water into the gutter.

Conclusions: This overlap system is minimal and effective, it reduces the overlapping surface, allowing a considerable saving of material and costs over time without sacrificing the seal against water infiltrations.

APPLICAZIONI SANDWICH IN OPERA

Nell'ambito dell'involucro degli edifici, le lamiere grecate sono solitamente utilizzate in abbinamento a pannelli isolanti e/o strati impermeabilizzanti. Le coperture sandwich in opera sono realizzate interponendo fra due lamiere uno o più strati isolanti: vd figure A) e B).

SANDWICH APPLICATIONS ON SITE

As part of the building envelope, corrugated sheets are usually used in combination with insulating panels and / or waterproofing layers. The sandwich roofs on site are made by interposing one or more insulating layers between two sheets: see figures A) and B).

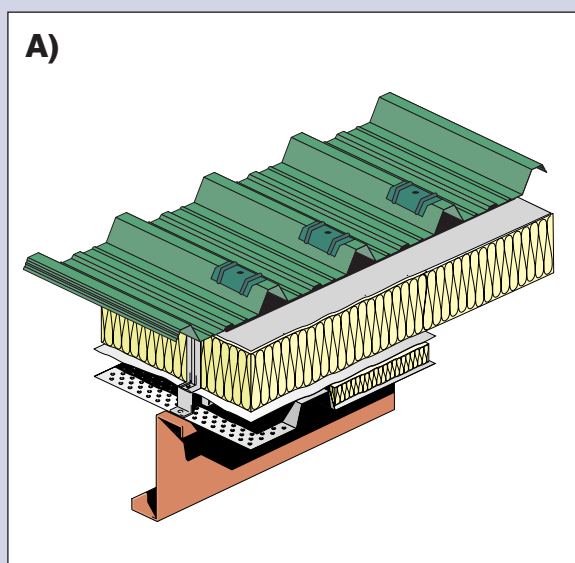

La lamiera inferiore o interna è disposta con le nervature ortogonali alla linea di massima pendenza, mentre la lamiera superiore ha le nervature parallele alla linea di massima pendenza.

The lower or internal sheet is arranged with the ribs positioned orthogonally to the line of maximum slope, while the upper sheet has the ribs parallel to the line of maximum slope.

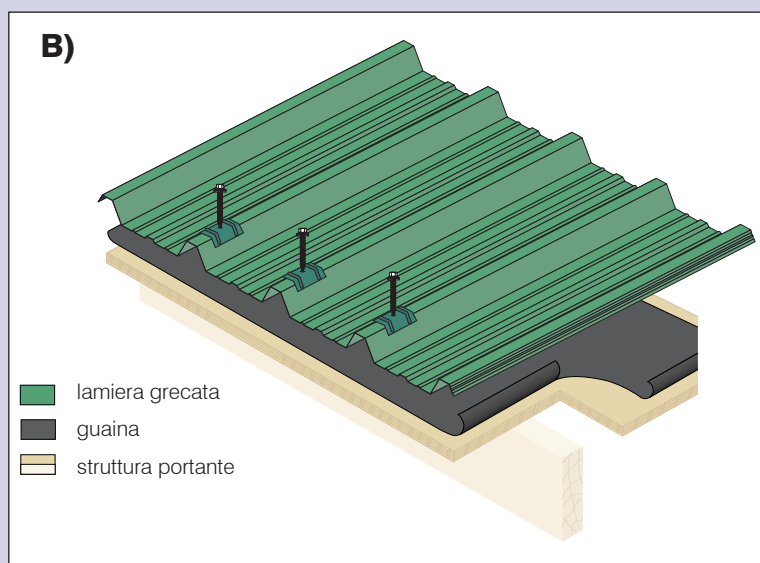

Copertura semplice realizzata mediante applicazione di lamiera grecata sull'orditura portante costituita da travi e tavolato in legno con interposta guaina impermeabilizzante.

Simple roofing made by applying corrugated sheets on the load-bearing framework consisting of wooden beams and planking with an interposed waterproofing sheath.





È disponibile un'ampia gamma di colori standard e speciali per ogni tipo di esigenza dell'edilizia civile ed industriale. I colori riportati in tabella fanno riferimento alla classificazione RAL, ma è possibile richiedere colori speciali (previo accordi sulle minime quantità).

A wide range of standard and special colors, available for all types of civil and industrial building requirements. The colors shown in the table refer to the RAL classification, but there are many other shades that can be supplied to the customer on request (subject to agreement on minimum quantities).



**COLORI STANDARD RAL:
STANDARD RAL COLORS:**



RAL 9002

Bianco Grigio
Grey White



RAL 3009

Rosso Siena
(ossido)
Oxide red



RAL 8019

Testa di Moro
Grey Brown

È utile sapere che, nelle preverniciature poliestere standard, i colori chiari hanno un basso fattore di deterioramento nel tempo e sono pertanto consigliati in zone geografiche con alti livelli di soleggiamento.

It is useful to know that, standard polyester preverniciature, light colors have a low deterioration factor over time and therefore recommended in geographical areas with high levels of sunshine.

**GAMMA COLORI SPECIALI PIÙ RICHIESTI.
MOST REQUESTED SPECIAL COLORS.**

**(colore simil RAL - RAL like colour)*



3000*
Rosso Fuoco
Flame Red



6021*
Verde Pallido
Pale Green



7006*
Grigio Beige
Beige Grey

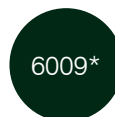

6009*
Verde Abete
Fir Green

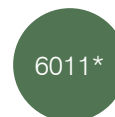

6011*
Verde Reseda
Reseda Green



5013*
Blu Cobalto
Cobalt Blue

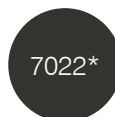

7022*
Grigio Ombra
Umbr Grey

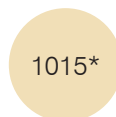

1015*
Avorio Chiaro
Light Ivory



9006*
Alluminio Brillante
White Aluminium



7012*
Grigio Basalto
Basalt Grey

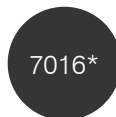

7016*
Grigio Antracite
Anthracite Grey

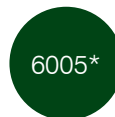

6005*
Verde Muschio
Moss Green



1014*
Avorio
Ivory



9010*
Bianco Puro
Pure White

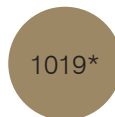

1019*
Beige Grigiastro
Grey Beige



5010*
Blu Genziana
Gentian Blue

TESSUTO ANTICONDENSA ANTI-CONDENSATION FELTS

Prodotto assorbente anticondensa, costituito da un tessuto-non-tessuto di colore grigio applicato alla superficie intradossale delle lastre grecate allo scopo di ridurre il fenomeno della condensa.

An anti-condensation non-woven product is applied in the bottom surface of corrugated sheets to reduce the build up of condensation.

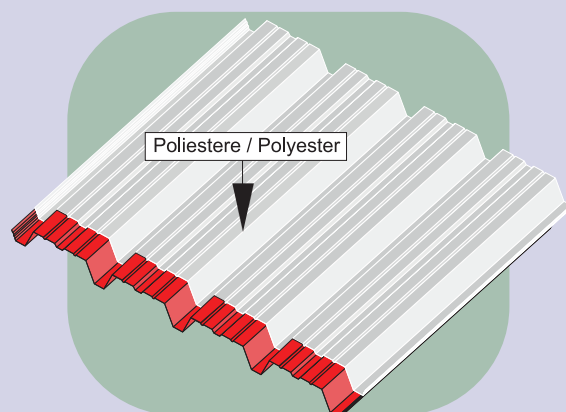

CARATTERISTICHE TECNICHE / TECHNICAL FEATURES	
Materiale / Material	Poliestere / Polyester

DISPONIBILE SUI SEGUENTI MODELLI - AVAILABLE ON THE FOLLOWING MODELS: R/W 1000, SILMA 6, SILMA 8, H20, H28, EUROSILMA		
Classe Reazione al fuoco / Fire reaction	A2-s1,d0	EN 13501-1
Peso / Weight	g/m ²	115 ± 10
Spessore (Tnt senza adesivo) Thickness (non woven without adhesive)	mm	0.65 ± 0.10
Colori / Colors	Bianco; grigio; beige / White; gray; beige	
Resistenza alla temperatura Temperature resistance	°C	200° C / 3'

MULTISTRATO ANTIRUMORE MULTILAYER ANTI-NOISE

Il sistema multistrato è basato su una struttura in polietilene reticolato espanso a cellule chiuse ad alta densità, dello spessore di 3 mm, applicato attraverso un sistema di accoppiamento in continuo sulla superficie interna della lastra.

Benefits:

- Riduzione del rumore prodotto dalla pioggia battente e dagli altri agenti atmosferici in misura superiore al tessuto anticondensa tradizionale.
- Riduzione dell'eventuale condensa all'intradosso delle coperture metalliche grazie al miglioramento dell'isolamento termico.

The multilayer system is based on a high density closed cell expanded cross-linked polyethylene structure of 3 mm thick, applied through a continuous coupling system on the internal surface of the sheet.

Benefits:

- Reduction of the noise produced by driving rain and other atmospheric agents to a greater extent than traditional anti-condensation fabric.
- Reduction of any condensation on the intrados of metal roofs thanks to the improvement of thermal insulation.

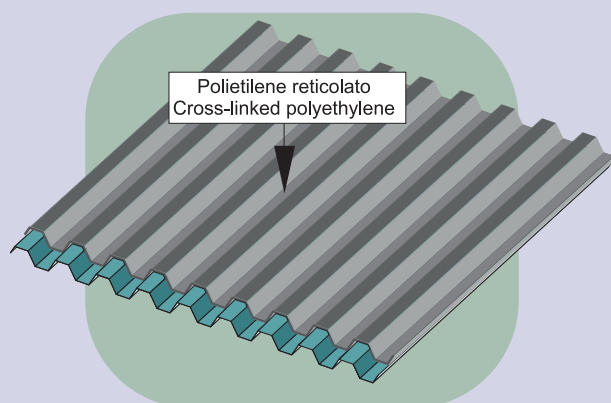

DISPONIBILE SUI SEGUENTI MODELLI - AVAILABLE ON THE FOLLOWING MODELS: H28		
Densità / Density	kg/m ³	30
Spessore (Tnt senza adesivo) Thickness (non woven without adhesive)	mm	3



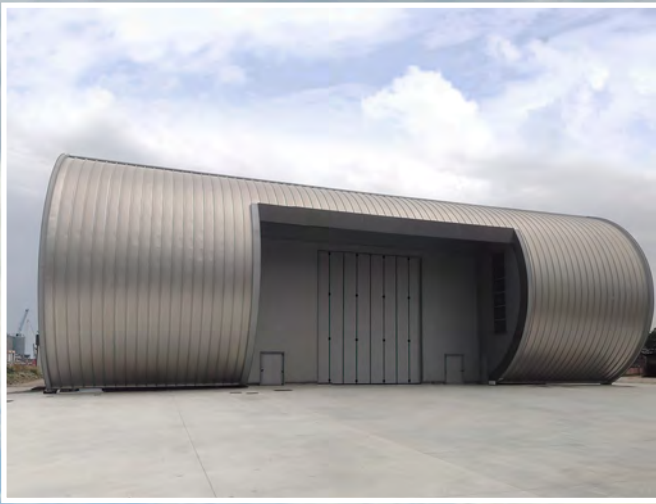

Drytec è lo speciale sistema di copertura a giunto drenante adatto per ogni copertura. La tecnologia racchiusa nel sormonto, l'assenza di fissaggi passanti e la qualità dei materiali impiegati hanno permesso a **Drytec** di superare rigidi test di laboratorio che ne garantiscono l'efficacia. Per questo **Drytec** sfida le condizioni estreme a cui può essere sottoposta la copertura. La continua attività di ricerca e sviluppo fa sì che questo speciale sistema sia completo di tutti i componenti di finitura e accessori, anche compatibili con i sistemi per la produzione di energia fotovoltaica. Il nostro staff, formato da tecnici, funzionari e operatori di mercato, dispone delle competenze necessarie per una consulenza completa, dalla progettazione alla messa in opera.

Drytec is a special joint drainage covering system suitable for any roof solution. The technology contained in the overlap, the absence of brace fasteners and the quality of the materials have enabled **Drytec** to overcome rigid laboratory tests that guarantee its effectiveness. Therefore, **Drytec** challenges extreme weather conditions with any covering system. Continuous research and development ensures that this special system is complete with all finishing components, accessories and various solutions for the production of photovoltaic energy. The staff is made up of engineers and market specialists who have the right skills needed to provide comprehensive advice, from the design phase to implementation.

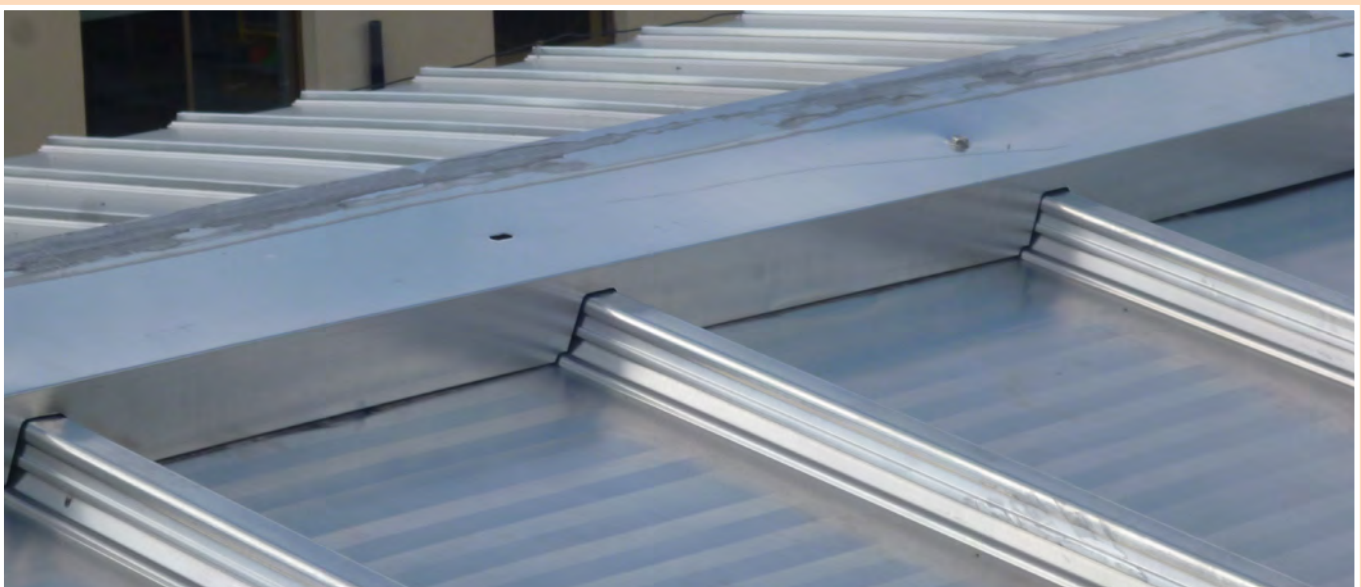



Le grecate Drytec sono prodotte in un unico elemento senza giunti di testa, e sono curvabili a seconda del raggio richiesto dal progetto. Il montaggio è rapido e semplice grazie al fissaggio a scatto che non prevede aggraffature meccaniche.

Drytec corrugated panels are produced in a single element without butt joints, they can be bent according to the radius required by the project. Assembly is quick and easy thanks to the snap fastening that does not require mechanical crimping.

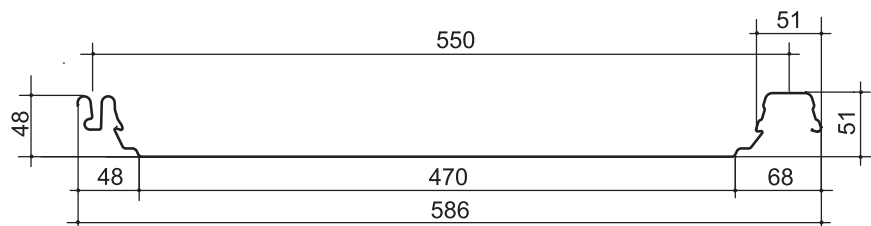

staffa **Dryblock** / **Dryblock** bracket

Nei disegni, A o B indicano il lato preverniciato desiderato.
In the drawings A or B show the wished prepainted side.

COMPORTAMENTO AL FUOCO / FIRE REACTION	
Reazione al fuoco / Fire reaction class	A1 - UNI EN 13501-1
Comportamento al fuoco dall'esterno / External fire performance	Roof - UNI EN 13501-5 - CWFT – UNI ENV 1187

Caratteristiche tecniche - Datasheet

Dimensioni: larghezza 550, lunghezza a richiesta da produzione in continuo.

Spessori: fino a mm 0,8 - anche non standard su richiesta.

Supporti: acciaio zincato preverniciato o plastificato; Aluzinc; acciaio inox; alluminio naturale, preverniciato o goffrato.

Trattamenti protettivi applicabili a richiesta: Preverniciatura con poliesteri, superpoliesteri (hd), pvdf, poliuretani pur/pa, con spessori compresi tra 15 µm a 55 µm. Disponibilità su richiesta di altri film e rivestimenti.

Dimensions: width 550, length upon request from continuous production process.

Thicknesses (S): up to mm 0,8 - also non-standard on request.

Supports: prepainted or plasticized galvanized steel; Aluzinc; stainless steel; natural, prepainted or embossed aluminum.

Protective treatments for external support available on request: Pre-painting with polyester, superpolyester (hd), pvdf, polyurethane pur/pa, with thicknesses ranging from 15 µm to 55 µm. Availability on request of other films and coatings.

CARATTERISTICHE MECCANICHE (Kg/cm2) / MECHANICAL PROPERTIES (Kg/cm2)		
Materiale / Material	Carico di Snervamento / Stress at Yield	Carico di Rottura / Stress at break
Alluminio 5754 H18 / Aluminium 5754 H18	2000	2300
Acciaio / Steel	2500	3300

CARATTERISTICHE GEOMETRICHE / GEOMETRICAL CHARACTERISTICS				
Spessore / Thickness (mm)	0,60	0,70	0,80	1,00
Jx (cm ⁴ /m) / Jx (cm ⁴ /m)	11,79	13,75	15,73	19,65
Wx (cm ³ /m) / Wx (cm ³ /m)	3,00	3,49	3,99	4,98
Jx (cm ⁴ /lastra) / Jx (cm ⁴ /sheet)	6,49	7,57	8,65	10,81
Wx (cm ³ /lastra) / Wx (cm ³ /sheet)	1,65	1,92	2,20	2,74



CRITERI DI CALCOLO / CALCULATION CRITERIA

Fattore di sicurezza di calcolo = 3 / Calculation safety factor = 3

$M_{max} = q \cdot l^2 / 10$ / $M_{max} = q \cdot l^2 / 10$

$f_{max} = 2,6 / 384 \cdot q \cdot l^4 / EJ$ / $f_{max} = 2,6 / 384 \cdot q \cdot l^4 / EJ$

TABELLE DI PORTATA PER CARICHI UNIFORMEMENTE DISTRIBUITI (daN/m²) /
SHEET CAPACITIES FOR UNIFORMLY DISTRIBUTED LOADS (daN/m²)

Materiale / Material	Spessore / Thickness (mm)	Interasse Appoggi (m) / Distance between supports (m)					
		1	1,2	1,4	1,6	1,8	2
Alluminio 5457 H18 / Aluminium 5754 H18	0,70	404	280	205	156	123	99
	0,80	462	320	234	179	141	113
	1,00	576	399	292	223	175	141
Acciaio / Steel	0,60	448	309	226	171	134	107
	0,80	596	411	300	228	178	143

La semplicità di montaggio delle staffe **Dryblock** consente una facile posa del sistema **Drytec**, garantendone la resistenza, anche sotto l'azione di forti venti.

*Installation The simplicity of the **Dryblock** bracket allows an easy installation of the entire **Drytec** system, guaranteeing a secure resistance of the system itself, even in strong winds.*

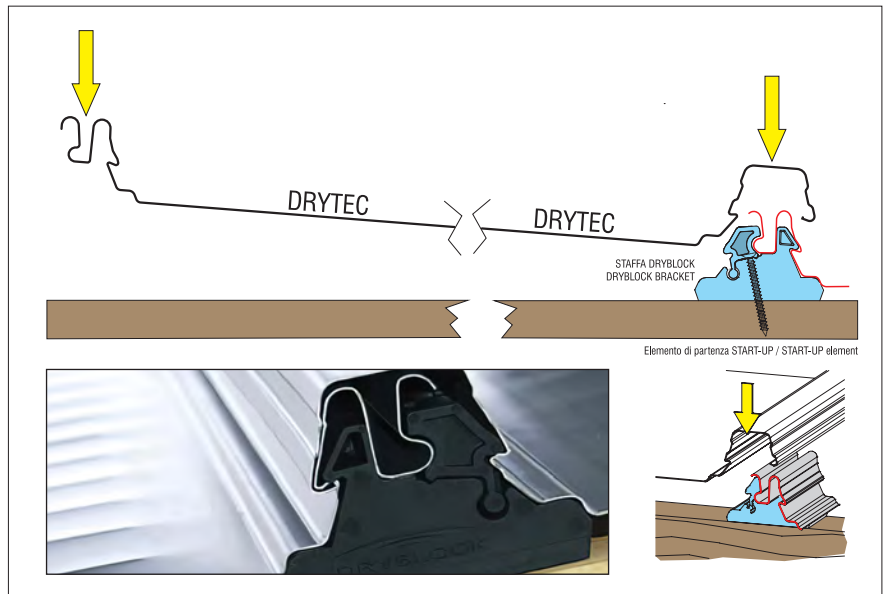
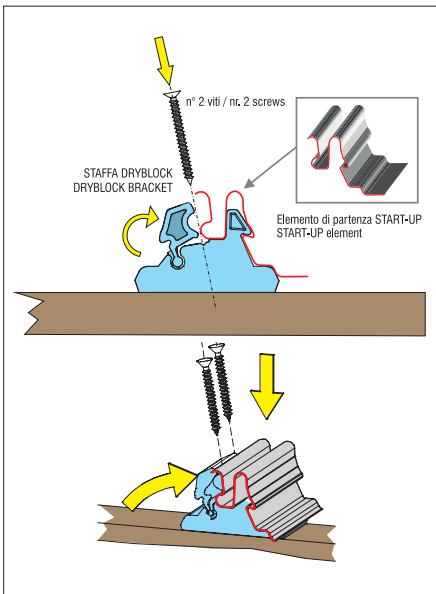

1) Posizionare correttamente la staffa **Dryblock** sulla struttura sottostante (legno o acciaio). Inserire l'elemento di partenza "start-up" nella staffa **Dryblock**. Inserire i fissaggi negli appositi fori. La staffa **Dryblock** si ancorerà allo "start-up".

2) Fissare le viti alla struttura in modo da fermare saldamente la staffa **Dryblock**, con annesso "start-up", alla struttura. Posizionare la lastra **Drytec** sormontando la greca all'elemento di partenza. Imprimere pressione alla lastra **Drytec** cosicché si vada ad ancorare all'elemento di partenza (bloccaggio a scatto).

1) Correctly position the **Dryblock** bracket on the underlying structure (wood or steel). Insert the "start-up" element in the **Dryblock** bracket. Insert the fasteners in the perforations provided. The **Dryblock** bracket will anchor itself to the "start-up".

2) Fasten the screws to the structure so as to stop the **Dryblock** bracket securely, with the "start-up" element, to the structure. Position the **Drytec** sheet by overlapping the rib to the starting element. Apply pressure to the **Drytec** sheet so that it anchors itself to the starting element (snap lock).

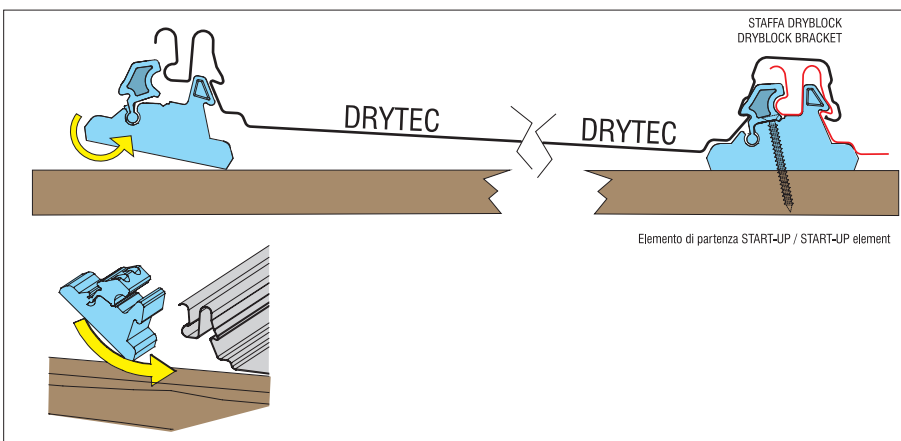

3) Posizionare la successiva staffa **Dryblock** nella parte inferiore del sormonto maschio della lastra **Drytec** con aggancio a scatto.

3) Place the next **Dryblock** bracket in the lower part of the male overlap of the **Drytec** sheet with snap connection.

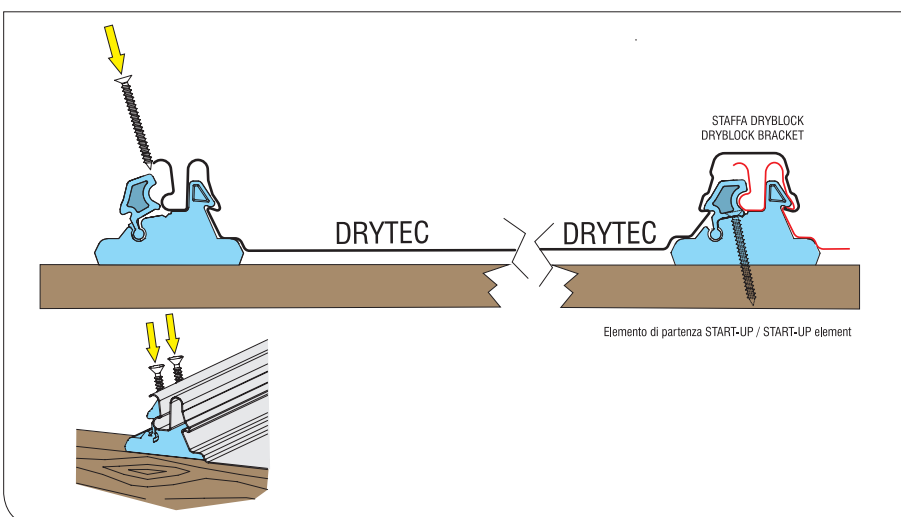

4) Fissare, con gli appositi fissaggi, la **Dryblock** alla struttura. Si sarà così fissata la prima lastra **Drytec**.

4) Fasten the **Dryblock** to the structure with the appropriate hardware. This is how the first **Drytec** sheet should be fastened.

5) Ripetere i passaggi 2, 3 e 4 per tutte le successive lastre fino a completamento della copertura **Drytec**.

5) Repeat steps 2, 3 and 4 for all the subsequent sheets until **Drytec** roof is complete.

**AUTOCENTINATURA DEL SISTEMA DRYTEC
DRYTEC SYSTEM SELF-ARCHING**

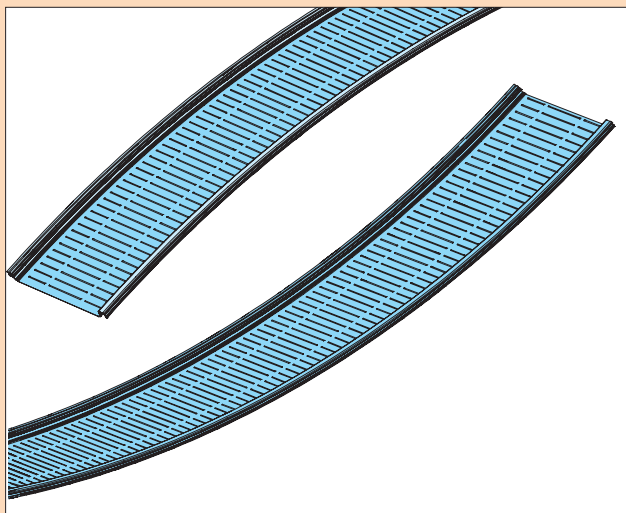

Le lastre **Drytec** sono autocentrinanti per raggi di curvatura superiori ai 22 m. È possibile la calandratura delle lastre a partire da un raggio minimo pari a 3 m.

*The **Drytec** sheets are automatically cambered for radiuses greater than 22 m. Calendaring processing is available starting with a minimum radius of 3 m.*



Per l'applicazione del fotovoltaico si prevede l'utilizzo della staffa **Multiblock** che consente l'installazione dei componenti aggiuntivi senza praticare fori.

*The **Multiblock** bracket allows additional components and devices (e.g. photovoltaic panels) to be installed without having to drill holes.*

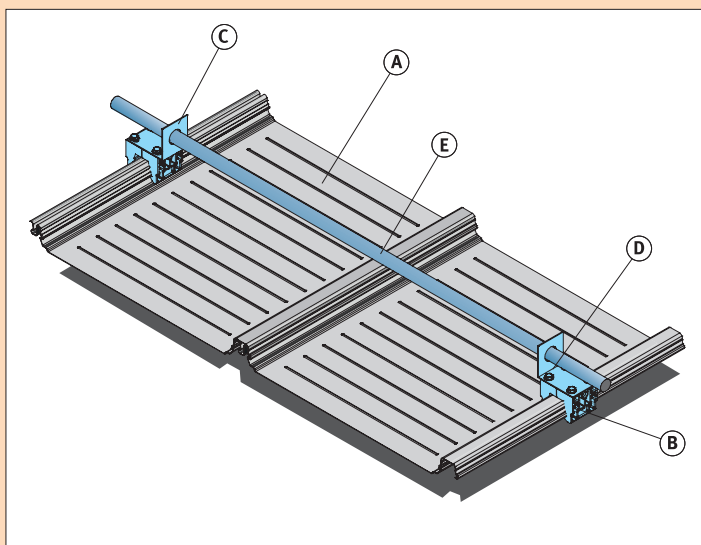

Il sistema **Drytec** è provvisto di una gamma completa di accessori. Gradini per falde inclinate, grigliati per pedonamento, fermaneve, sistemi di sicurezza anticaduta, staffe multiuso, ecc...

The Drytec system is equipped with a complete range of accessories. Steps for pitched slopes, pedestrian gratings, snow stops, fall protection systems, multipurpose brackets, etc...

SISTEMA FERMANEVE - SNOW STOP SYSTEM

- A. Lastra - Slab **Drytec**.
- B. Staffa - Bracket **Multiblock**.
- C. Staffa Fermaneve - Snow stop bracket.
- D. Viti in Acciaio Inox - Stainless steel screws M8.
- E. Barra Fermaneve - Snow stop bar Ø 25 [mm] **Drytec**.

Staffa **Multiblock** e profili in alluminio per impianto fotovoltaico.

Multiblock bracket and aluminum profiles for photovoltaic system.



Staffa **Multiblock** installata su sormonto.

Multiblock bracket installed on overlap.



Staffa **Multiblock** abbinata ad una linea vita.

Multiblock bracket combined with a lifeline.

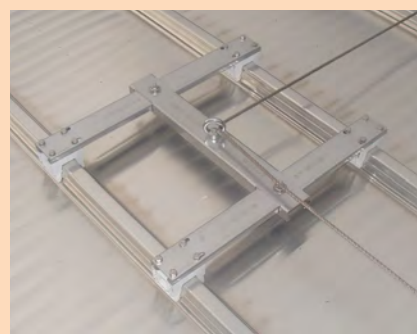



L'impiego delle lamiere grecate nelle costruzioni dei solai, a secco o con getto in cemento, ha rappresentato, fin dalla sua introduzione, una profonda innovazione nel panorama edile e architettonico, e ha reso possibile razionalizzare e accelerare i tempi di realizzazione, con un conseguente importante beneficio economico.

Greche più alte rispetto alle normali lamiere da copertura e rivestimento permettono una forte resistenza alle flessioni e garantiscono elevate portate. L'ampia gamma a catalogo include modelli con funzione di cassaforma a perdere, non collaboranti, a semplice contenimento del calcestruzzo oppure con aderenza migliorata, ideali su strutture prefabbricate (riportate nella sezione *Lamiera da Solaio CLS AM*). Sono inoltre disponibili versioni con greche di altezze e passi diversi, studiate in modo da adattarsi a spazi con luci più e meno ampie. Le lamiere grecate strutturali combinano elevate performance di isolamento e sicurezza con linee esteticamente armoniche e leggere.

The use of corrugated sheets in the construction of floors, dry or with concrete casting, has represented, since its introduction, a profound innovation in the building and architectural panorama, and has made it possible to rationalize and accelerate construction times, with a consequent important economic benefit.

Higher ribs than normal roofing and cladding sheets allow a strong resistance to bending and guarantee high capacities. The wide range in the catalog includes models with disposable formwork, non-collaborating, with simple containment of the concrete or with improved adhesion, ideal for prefabricated structures (shown in the floor metal sheets concrete slab section). Versions with ribs of different heights and pitches are also available, in order to adapt to spaces with more and less wide spans.

Structural corrugated sheets combine high insulation and safety performance with aesthetically harmonic and light lines.

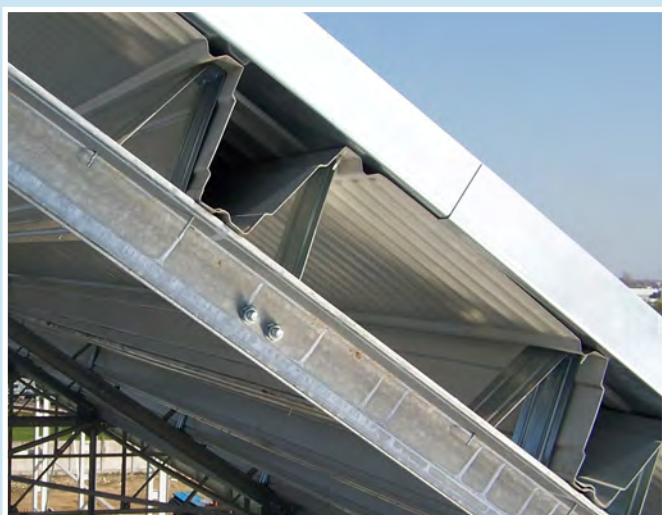

MODELLO MODEL	MATERIALE MATERIAL	APPLICAZIONI	
		Solaio a secco Slab	Solaio AM Slab concrete
S/C 2000	Acciaio Zincato, Acciaio zincato preverniciato / Prepainted steel, Galvanized steel	✓	
S/C 2000 AM	Acciaio Zincato / Galvanized steel		✓
R/C 400	Acciaio Zincato, Acciaio zincato preverniciato / Prepainted steel, Galvanized steel	✓	
R/C 400 AM	Acciaio Zincato / Galvanized steel		✓
E/S 4000	Acciaio Zincato, Acciaio zincato preverniciato / Prepainted steel, Galvanized steel	✓	
E/S 4000 AM	Acciaio Zincato / Galvanized steel		✓
LG 55	Acciaio Zincato, Acciaio zincato preverniciato / Prepainted steel, Galvanized steel	✓	
LG 75	Acciaio Zincato, Acciaio zincato preverniciato / Prepainted steel, Galvanized steel	✓	
TECNODEC 105	Acciaio Zincato, Acciaio zincato preverniciato / Prepainted steel, Galvanized steel	✓	
TECNODEC 150	Acciaio Zincato, Acciaio zincato preverniciato / Prepainted steel, Galvanized steel	✓	

S/C 2000 DECK / LAMIERA DA SOLAIO - SLAB CORRUGATED SHEET



CLASSE / CLASS



La gamma Deck nasce per soddisfare esigenze complesse in termini di copertura. S/C 2000 a 6 greche è utilizzabile anche per solai a secco. Garantisce rapidità di posa e una sezione di soletta molto contenuta ed è disponibile anche nella versione AM (aderenza migliorata).

The Deck range was created to meet complex needs in terms of coverage. S/C 2000 with 6 ribs can also be used for dry floors. It guarantees quick installation and a very contained slab section and is also available in the AM version (improved grip).

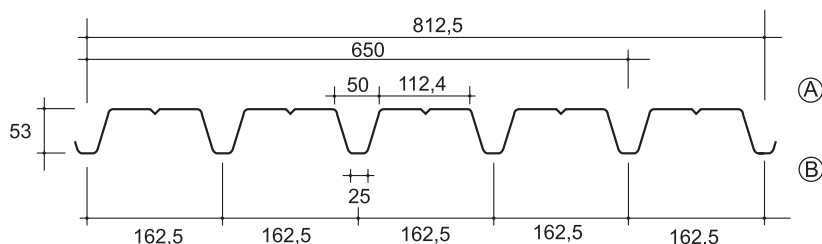

Nei disegni, A o B indicano il lato preverniciato desiderato.
In the drawings A or B show the wished pre-painted side.

Nome del prodotto Product name	Numero greche Number of ribs	Interasse greche Pitch	Altezza greca Rib height	Larghezza greca Rib width	Base greca Rib long base	Larghezza modulo Covering width	Numero greche di sormonto Rib overlap
	(nr)	(mm)	(mm)	(mm)	(mm)	(mm)	(nr)
S/C 2000	6	162,5	53	25	50	812,5	1

Caratteristiche tecniche - Datasheet

Dimensioni: larghezza 812,5 (mm), lunghezza a richiesta da produzione in continuo.

Spessori: fino a mm 1,5 - anche non standard su richiesta.

Alcune tipologie di acciaio, fornibili a richiesta previo accordo sui quantitativi minimi: S 235; S 250 GD+Z; S 260 NC; S 275; S 280 GD+Z; S 315 MC; S 315 NC; S 320 GD+Z (ed altri ancora).

Supporti: acciaio zincato preverniciato o plastificato;
Trattamenti protettivi applicabili a richiesta: Preverniciatura con poliesteri, superpoliesteri (hd) Disponibilità su richiesta di altri film e rivestimenti.

Dimensions: width 812,5 (mm), length upon request from continuous production process.

Thicknesses (S): up to mm 1,5 - also non-standard on request.

Some types of steel supplied upon request previous agreement on minimum quantities: S 235; S 250 GD+Z; S 260 NC; S 275; S 280 GD+Z; S 315 MC; S 315 NC; S 320 GD+Z (and others more).

Supports: pre-painted or plasticized galvanized steel;
Protective treatments for external support available on request: Pre-painting with polyester, superpolyester (hd). Availability on request of other films and coatings.

S/C 2000 DECK - ACCIAIO S 250 GD+Z / STEEL S 250 GD+Z CARATTERISTICHE STATICHE / STATIC CHARACTERISTICS													
spessore lamiera - sheet metal thickness	Peso weight (passo) 812,5 mm	PROPRIETA' DI MASSA LORDE: GROSS MASS PROPERTY:				PROPRIETA' DI MASSA EFFICACI: - EFFECTIVE MASS PROPERTIES:							
		A	J _{xG}	W _{e sup}	W _{e inf}	MOMENTO POSITIVO IN CAMPATA POSITIVE MOMENT ON SPAN				MOMENTO NEGATIVO SULL'APPOGGIO NEGATIVE MOMENT ON SUPPORT			
						A _{eff}	J _{xG eff}	W _{e sup eff}	W _{e inf eff}	A _{eff}	J _{xG eff}	W _{e sup eff}	W _{e inf eff}
						cm ² /m	cm ⁴ /m	cm ³ /m	cm ³ /m	cm ² /m	cm ⁴ /m	cm ³ /m	cm ³ /m
0,6	6,0	9,220	37,992	22,137	10,455	6,779	28,270	12,122	9,368	8,869	35,742	22,052	9,584
0,8	9,6	12,293	50,660	29,519	13,941	9,720	41,133	18,964	12,931	12,253	50,124	29,412	13,748
1,0	11,9	15,367	63,333	36,904	17,429	12,946	54,930	26,981	16,574	15,314	62,634	36,764	17,177
1,25	15,6	19,208	79,182	46,138	21,790	17,338	73,134	38,483	21,200	19,139	78,264	45,956	21,460
1,5	18,0	23,050	95,041	55,379	26,155	21,957	91,702	50,917	25,839	22,963	93,887	55,149	25,740

TABELLA DI PORTATA S/C 2000: ACCIAIO S 250 GD / LOAD TABLE S/C 2000: STEEL S 250 GD

I valori di portata in tabella non includono il peso proprio della lamiera grecata.
The capacity load shown in the table does not include the weight of the metal sheet itself.

TABELLA DI PORTATA S/C 2000 NORMALE: ACCIAIO S 250 GD / LOAD TABLE S/C 2000 NORMAL POSITION: STEEL S 250 GD																				
Appoggio esterno 100 mm; appoggio interno (non presente) / End support 100 mm; internal support (not present)																				
Coefficients di sicurezza sulle portate allo SLU (γ_q): 1,40 / Safety coefficient applied to SLU (γ_q): 1,40																				
PORTATA DEL PROFILO IN daN/m ² CON FRECCIA \leq L/180 max 20mm; L/200; L/250; L/300 / SHEET CAPACITY, daN /m ² WITH DEFLECTION \leq L/180 max 20mm; L/200; L/250; L/300 OF A SPAN																				
Spessore / thickness	(q) CARICO LIMITE LIMIT DESIGN DEFLECTION	 Distanza tra gli appoggi "L" in metri / Pitch "L" in metres between the supports																		
		freccia / deflection	1,50	1,75	2,00	2,25	2,50	2,75	3,00	3,25	3,50	3,75	4,00	4,25	4,50	4,75	5,00	5,25	5,50	5,75
0,60	q lim SLU	577	424	325	257	208	172	144	123	106	92	81	72	64	58	52	47	43	39	36
	q lim (L/180*)	577	424	323	227	165	124	96	75	60	47	36	28	23	18	15	12	-	-	-
	q lim (L/200)	577	424	290	204	149	112	86	68	54	44	36	30	26	22	19	16	-	-	-
	q lim (L/250)	551	347	232	163	119	89	69	54	43	35	29	24	20	17	15	13	-	-	-
	q lim (L/300)	459	289	194	136	99	74	57	45	36	29	24	20	17	14	12	11	-	-	-
0,80	q lim SLU	797	586	448	354	287	237	199	170	146	128	112	99	89	79	72	65	59	54	50
	q lim (L/180*)	797	586	448	330	240	181	139	109	88	68	53	41	33	27	22	18	-	-	-
	q lim (L/200)	797	586	423	297	216	163	125	98	79	64	53	44	37	32	27	23	20	-	-
	q lim (L/250)	797	505	338	237	173	130	100	79	63	51	42	35	30	25	22	19	16	-	-
	q lim (L/300)	668	421	282	198	144	108	83	66	53	43	35	29	25	21	18	16	14	-	-
1,00	q lim SLU	1142	839	642	507	411	340	285	243	210	183	161	142	127	114	103	93	85	78	71
	q lim (L/180*)	1142	839	642	507	370	278	214	169	135	105	81	64	51	41	33	27	23	-	-
	q lim (L/200)	1142	839	642	457	333	250	193	152	121	99	81	68	57	49	42	36	31	-	-
	q lim (L/250)	1142	777	521	366	267	200	154	121	97	79	65	54	46	39	33	29	25	-	-
	q lim (L/300)	1028	648	434	305	222	167	129	101	81	66	54	45	38	32	28	24	21	-	-
1,25	q lim SLU	1449	1064	815	644	521	431	362	309	266	232	204	180	161	144	130	118	108	99	91
	q lim (L/180*)	1449	1064	815	635	463	348	268	211	169	132	102	80	63	51	42	34	28	-	-
	q lim (L/200)	1449	1064	814	571	417	313	241	190	152	123	102	85	71	61	52	45	39	-	-
	q lim (L/250)	1449	972	651	457	333	250	193	152	121	99	81	68	57	49	42	36	31	-	-
	q lim (L/300)	1286	810	542	381	278	209	161	126	101	82	68	57	48	40	35	30	26	-	-
1,50	q lim SLU	1764	1296	992	784	635	525	441	376	324	282	248	220	196	176	159	144	131	120	110
	q lim (L/180*)	1764	1296	992	762	556	417	322	253	202	158	122	96	76	61	50	41	34	-	-
	q lim (L/200)	1764	1296	977	686	500	376	289	228	182	148	122	102	86	73	63	54	47	-	-
	q lim (L/250)	1764	1166	781	549	400	301	231	182	146	119	98	81	69	58	50	43	38	-	-
	q lim (L/300)	1543	972	651	457	333	250	193	152	121	99	81	68	57	49	42	36	31	-	-
LEGENDA / INDEX																				
Valori carico ammissibile uniformemente distribuito <i>Distributed load and resistance factor design</i>	>	Per la condizione di Stato Limite Ultimo (SLU) della lamiera / <i>Ultimate limit-state design of the corrugated sheet (SLU)</i>																		
	>	Per la condizione di Stato Limite di Esercizio (SLE) della lamiera ($F \leq$ L/180; L/200; L/250; L/300) / <i>Serviceability limit of the corrugated sheet (SLE) ($F \leq$ L/180; L/200; L/250; L/300)</i>																		
	>	Per la condizione di Stato Limite di Esercizio (SLE) della lamiera ($F \leq$ *solo max 20mm) / <i>Serviceability limit of the corrugated sheet (SLE) ($F \leq$ only max 20mm)</i>																		

I rapporti di prova pubblicati in questo catalogo vengono forniti a titolo puramente indicativo. I dati pubblicati sono stati calcolati secondo le Norme vigenti: NTC2018, Circolare esplicativa alle NTC2018, UNI EN 1993 (EC3). Per una corretta applicazione del prodotto sarà onere e cura del cliente e/o del progettista la redazione di calcoli appropriati con specifico riferimento al singolo impiego.

The test reports published in this catalogue are provided for indicative purposes only. The published data have been calculated according to the current regulations: NTC2018, Explanatory circular to NTC2018, UNI EN 1993 (EC3). For a correct application of the product, it will be responsibility and care of the customer and/or the designer to draw up appropriate calculations with specific reference to the individual use.

TABELLA DI PORTATA S/C 2000: ACCIAIO S 250 GD / LOAD TABLE S/C 2000: STEEL S 250 GD

I valori di portata in tabella non includono il peso proprio della lamiera grecata.
The capacity load shown in the table does not include the weight of the metal sheet itself.

TABELLA DI PORTATA S/C 2000 NORMALE: ACCIAIO S 250 GD / LOAD TABLE S/C 2000 NORMAL POSITION: STEEL S 250 GD																				
Appoggio esterno 100 mm; appoggio interno 100 mm / End support 100 mm; internal support 100 mm																				
Coefficients di sicurezza sulle portate allo SLU (γ_q): 1,40 / Safety coefficient applied to SLU (γ_q): 1,40																				
PORTATA DEL PROFILO IN daN/m ² CON FRECCIA \leq L/180 max 20mm; L/200; L/250; L/300 / SHEET CAPACITY, daN/m ² WITH DEFLECTION \leq L/180 max 20mm; L/200; L/250; L/300 OF A SPAN																				
Spessore / thickness	(q) CARICO LIMITE LIMIT DESIGN DEFLECTION																			
		Distanza tra gli appoggi "L" in metri / Pitch "L" in metres between the supports																		
mm	freccia / deflection	1,50	1,75	2,00	2,25	2,50	2,75	3,00	3,25	3,50	3,75	4,00	4,25	4,50	4,75	5,00	5,25	5,50	5,75	6,00
0,60	q lim SLU	474	367	293	239	199	168	144	125	109	95	83	74	66	59	53	48	44	40	37
	q lim (L/180*)	474	367	293	239	199	168	144	125	109	95	83	69	55	45	36	30	-	-	-
	q lim (L/200)	474	367	293	239	199	168	144	125	109	95	83	74	62	53	45	39	34	-	-
	q lim (L/250)	474	367	293	239	199	168	144	125	106	86	71	59	50	42	36	31	27	-	-
	q lim (L/300)	474	367	293	239	199	168	140	110	88	72	59	49	41	35	30	26	23	-	-
0,80	q lim SLU	712	549	436	355	295	249	212	181	156	136	119	106	94	85	76	69	63	58	53
	q lim (L/180*)	712	549	436	355	295	249	212	181	156	136	119	101	80	65	53	43	-	-	-
	q lim (L/200)	712	549	436	355	295	249	212	181	156	136	119	106	90	77	66	57	50	-	-
	q lim (L/250)	712	549	436	355	295	249	212	181	154	125	103	86	72	62	53	46	40	35	31
	q lim (L/300)	712	549	436	355	295	249	204	160	128	104	86	72	60	51	44	38	33	29	25
1,00	q lim SLU	994	764	605	492	407	340	285	243	210	183	161	142	127	114	103	93	85	78	71
	q lim (L/180*)	994	764	605	492	407	340	285	243	210	183	161	142	124	100	81	67	55	46	39
	q lim (L/200)	994	764	605	492	407	340	285	243	210	183	161	142	127	114	102	88	76	67	59
	q lim (L/250)	994	764	605	492	407	340	285	243	210	183	159	132	111	95	81	70	61	53	47
	q lim (L/300)	994	764	605	492	407	340	285	243	197	160	132	110	93	79	68	58	51	45	39
1,25	q lim SLU	1318	1007	795	644	521	431	362	309	266	232	204	180	161	144	130	118	108	99	91
	q lim (L/180*)	1318	1007	795	644	521	431	362	309	266	232	204	180	155	125	102	84	69	58	49
	q lim (L/200)	1318	1007	795	644	521	431	362	309	266	232	204	180	161	144	127	110	95	83	73
	q lim (L/250)	1318	1007	795	644	521	431	362	309	266	232	198	165	139	118	102	88	76	67	59
	q lim (L/300)	1318	1007	795	644	521	431	362	308	247	201	165	138	116	99	85	73	64	56	49
1,50	q lim SLU	1657	1262	992	784	635	525	441	376	324	282	248	220	196	176	159	144	131	120	110
	q lim (L/180*)	1657	1262	992	784	635	525	441	376	324	282	248	220	186	150	122	100	83	70	59
	q lim (L/200)	1657	1262	992	784	635	525	441	376	324	282	248	220	196	176	152	132	114	100	88
	q lim (L/250)	1657	1262	992	784	635	525	441	376	324	282	238	199	167	142	122	105	92	80	71
	q lim (L/300)	1657	1262	992	784	635	525	441	370	296	241	198	165	139	118	102	88	76	67	59
LEGENDA / INDEX																				
Valori carico ammissibile uniformemente distribuito Distributed load and resistance factor design	>	Per la condizione di Stato Limite Ultimo (SLU) della lamiera / <i>Ultimate limit-state design of the corrugated sheet (SLU)</i>																		
	>	Per la condizione di Stato Limite di Esercizio (SLE) della lamiera ($F \leq$ L/180; L/200; L/250; L/300) / <i>Serviceability limit of the corrugated sheet (SLE) ($F \leq$ L/180; L/200; L/250; L/300)</i>																		
	>	Per la condizione di Stato Limite di Esercizio (SLE) della lamiera ($F \leq$ *solo max 20mm) / <i>Serviceability limit of the corrugated sheet (SLE) ($F \leq$ only max 20mm)</i>																		

I rapporti di prova pubblicati in questo catalogo vengono forniti a titolo puramente indicativo. I dati pubblicati sono stati calcolati secondo le Norme vigenti: NTC2018, Circolare esplicativa alle NTC2018, UNI EN 1993 (EC3). Per una corretta applicazione del prodotto sarà onere e cura del cliente e/o del progettista la redazione di calcoli appropriati con specifico riferimento al singolo impiego.

The test reports published in this catalogue are provided for indicative purposes only. The published data have been calculated according to the current regulations: NTC2018, Explanatory circular to NTC2018, UNI EN 1993 (EC3). For a correct application of the product, it will be responsibility and care of the customer and/or the designer to draw up appropriate calculations with specific reference to the individual use.

TABELLA DI PORTATA S/C 2000: ACCIAIO S 250 GD / LOAD TABLE S/C 2000: STEEL S 250 GD

I valori di portata in tabella non includono il peso proprio della lamiera grecata.
The capacity load shown in the table does not include the weight of the metal sheet itself.

TABELLA DI PORTATA S/C 2000 NORMALE: ACCIAIO S 250 GD / LOAD TABLE S/C 2000 NORMAL POSITION: STEEL S 250 GD																				
Appoggio esterno 100 mm; appoggio interno 100 mm / End support 100 mm; internal support 100 mm																				
Coefficients di sicurezza sulle portate allo SLU (γ_q): 1,40 / Safety coefficient applied to SLU (γ_q): 1,40																				
PORTATA DEL PROFILO IN daN/m ² CON FRECCIA \leq L/180 max 20mm; L/200; L/250; L/300 / SHEET CAPACITY, daN/m ² WITH DEFLECTION \leq L/180 max 20mm; L/200; L/250; L/300 OF A SPAN																				
Spessore / thickness	(q) CARICO LIMITE LIMIT DESIGN DEFLECTION	 Distanza tra gli appoggi "L" in metri / Pitch "L" in metres between the supports																		
		freccia / deflection	1,50	1,75	2,00	2,25	2,50	2,75	3,00	3,25	3,50	3,75	4,00	4,25	4,50	4,75	5,00	5,25	5,50	5,75
0,60	q lim SLU	572	444	356	291	243	206	177	153	134	118	104	92	82	74	66	60	55	50	46
	q lim (L/180*)	572	444	356	291	243	206	177	144	115	90	70	55	43	35	28	23	19	16	14
	q lim (L/200)	572	444	356	291	243	206	165	130	104	84	70	58	49	42	36	31	27	23	21
	q lim (L/250)	572	444	356	291	228	171	132	104	83	68	56	46	39	33	28	25	21	19	16
	q lim (L/300)	572	444	356	260	190	143	110	86	69	56	46	39	33	28	24	21	18	16	14
0,80	q lim SLU	861	666	531	433	360	305	261	226	195	169	149	132	118	106	95	86	79	72	66
	q lim (L/180*)	861	666	531	433	360	305	261	210	168	131	101	79	63	51	41	34	28	24	20
	q lim (L/200)	861	666	531	433	360	305	240	189	151	123	101	84	71	60	52	45	39	34	30
	q lim (L/250)	861	666	531	433	331	249	192	151	121	98	81	67	57	48	41	36	31	27	24
	q lim (L/300)	861	666	531	379	276	208	160	126	101	82	67	56	47	40	35	30	26	23	20
1,00	q lim SLU	1206	929	738	601	499	421	357	304	262	228	201	178	159	142	128	117	106	97	89
	q lim (L/180*)	1206	929	738	601	499	421	357	304	258	202	156	122	97	78	64	52	44	36	31
	q lim (L/200)	1206	929	738	601	499	421	357	290	233	189	156	130	109	93	80	69	60	52	46
	q lim (L/250)	1206	929	738	601	499	383	295	232	186	151	125	104	88	74	64	55	48	42	37
	q lim (L/300)	1206	929	738	583	425	320	246	194	155	126	104	87	73	62	53	46	40	35	31
1,25	q lim SLU	1603	1229	973	789	652	539	453	386	333	290	255	226	201	181	163	148	135	123	113
	q lim (L/180*)	1603	1229	973	789	652	539	453	386	323	252	195	153	122	98	80	66	54	46	38
	q lim (L/200)	1603	1229	973	789	652	539	453	363	291	236	195	162	137	116	100	86	75	66	58
	q lim (L/250)	1603	1229	973	789	638	479	369	290	233	189	156	130	109	93	80	69	60	52	46
	q lim (L/300)	1603	1229	973	729	532	400	308	242	194	158	130	108	91	78	66	57	50	44	38
1,50	q lim SLU	2021	1543	1218	980	794	656	551	470	405	353	310	275	245	220	198	180	164	150	138
	q lim (L/180*)	2021	1543	1218	980	794	656	551	470	388	303	234	183	146	118	96	79	65	55	46
	q lim (L/200)	2021	1543	1218	980	794	656	551	436	349	284	234	195	164	140	120	103	90	79	69
	q lim (L/250)	2021	1543	1218	980	766	575	443	349	279	227	187	156	131	112	96	83	72	63	55
	q lim (L/300)	2021	1543	1218	876	638	480	369	291	233	189	156	130	109	93	80	69	60	52	46

LEGENDA / INDEX

Valori carico ammissibile uniformemente distribuito
Distributed load and resistance factor design

>
>
>

Per la condizione di Stato Limite Ultimo (SLU) della lamiera / *Ultimate limit-state design of the corrugated sheet (SLU)*
Per la condizione di Stato Limite di Esercizio (SLE) della lamiera ($F \leq L/180; L/200; L/250; L/300$) / *Serviceability limit of the corrugated sheet (SLE) ($F \leq L/180; L/200; L/250; L/300$)*
Per la condizione di Stato Limite di Esercizio (SLE) della lamiera ($F \leq$ *solo max 20mm) / *Serviceability limit of the corrugated sheet (SLE) ($F \leq$ only max 20mm)*

I rapporti di prova pubblicati in questo catalogo vengono forniti a titolo puramente indicativo. I dati pubblicati sono stati calcolati secondo le Norme vigenti: NTC2018, Circolare esplicativa alle NTC2018, UNI EN 1993 (EC3). Per una corretta applicazione del prodotto sarà onere e cura del cliente e/o del progettista la redazione di calcoli appropriati con specifico riferimento al singolo impiego.

The test reports published in this catalogue are provided for indicative purposes only. The published data have been calculated according to the current regulations: NTC2018, Explanatory circular to NTC2018, UNI EN 1993 (EC3). For a correct application of the product, it will be responsibility and care of the customer and/or the designer to draw up appropriate calculations with specific reference to the individual use.

S/C 2000 ROVESCIO / LAMIERA DA SOLAIO - SLAB CORRUGATED SHEET



CLASSE / CLASS

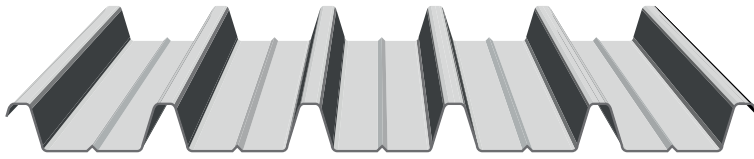

S/C 2000 a 6 greche, da copertura, è anche utilizzabile per solai a secco. Garantisce rapidità di posa e una sezione di soletta molto contenuta. Disponibile anche nella versione AM (aderenza migliorata).

S/C 2000 with 6 ribs, for roofing, can also be used for dry floors. It guarantees quick installation and a very contained section of the slab. Also available in the AM version (improved grip).

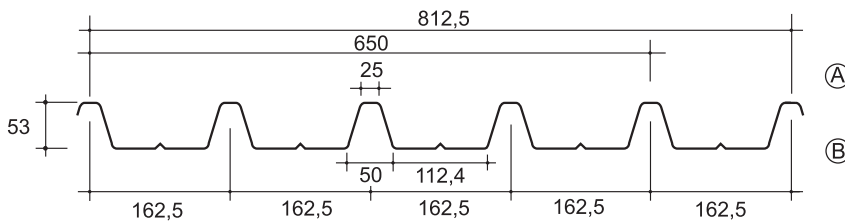

Nei disegni, A o B indicano il lato preverniciato desiderato.
In the drawings A or B show the wished prepainted side.

Nome del prodotto Product name	Numero greche Number of ribs	Interasse greche Pitch	Altezza greca Rib height	Larghezza greca Rib width	Base greca Rib long base	Larghezza modulo Covering width	Numero greche di sormonto Rib overlap
	(nr)	(mm)	(mm)	(mm)	(mm)	(mm)	(nr)
S/C 2000	6	162,5	53	25	50	812,5	1

Caratteristiche tecniche - Datasheet

Dimensioni: larghezza 812,5 (mm), lunghezza a richiesta da produzione in continuo.

Spessori: fino a mm 1,5 - anche non standard su richiesta.

Alcune tipologie di acciaio, fornibili a richiesta previo accordo sui quantitativi minimi: S 235; S 250 GD+Z; S 260 NC; S 275; S 280 GD+Z; S 315 MC; S 315 NC; S 320 GD+Z (ed altri ancora).

Supporti: acciaio zincato preverniciato o plastificato;
Trattamenti protettivi applicabili a richiesta: Preverniciatura con poliestere, superpoliestere (hd) Disponibilità su richiesta di altri film e rivestimenti.

Dimensions: width 812,5 (mm), length upon request from continuous production process.

Thicknesses (S): up to mm 1,5 - also non-standard on request.

Some types of steel supplied upon request previous agreement on minimum quantities: S 235; S 250 GD+Z; S 260 NC; S 275; S 280 GD+Z; S 315 MC; S 315 NC; S 320 GD+Z (and others more).

Supports: prepainted or plasticized galvanized steel;
Protective treatments for external support available on request: Pre-painting with polyester, superpolyester (hd). Availability on request of other films and coatings.

S/C 2000 ROVESCIO - ACCIAIO S 250 GD+Z / STEEL S 250 GD+Z CARATTERISTICHE STATICHE / STATIC CHARACTERISTICS													
spessore lamiera - sheet metal thickness	Peso weight (passo) 812,5 mm	PROPRIETA' DI MASSA LORDE: GROSS MASS PROPERTY:				PROPRIETA' DI MASSA EFFICACI: - EFFECTIVE MASS PROPERTIES:							
						MOMENTO POSITIVO IN CAMPATA POSITIVE MOMENT ON SPAN				MOMENTO NEGATIVO SULL'APPOGGIO NEGATIVE MOMENT ON SUPPORT			
		A	J _{xG}	W _{e sup}	W _{e inf}	A _{eff}	J _{xG eff}	W _{e sup eff}	W _{e inf eff}	A _{eff}	J _{xG eff}	W _{e sup eff}	W _{e inf eff}
		cm ² /m	cm ⁴ /m	cm ³ /m	cm ³ /m	cm ² /m	cm ⁴ /m	cm ³ /m	cm ³ /m	cm ² /m	cm ⁴ /m	cm ³ /m	cm ³ /m
0,6	6,0	9,220	37,992	10,455	22,137	8,869	35,742	9,584	22,052	6,779	28,270	9,368	12,122
0,8	9,6	12,293	50,660	13,941	29,519	12,253	50,124	13,748	29,412	9,720	41,133	12,931	18,964
1,0	11,9	15,367	63,333	17,429	36,904	15,314	62,634	17,177	36,764	12,946	54,930	16,574	26,981
1,25	15,6	19,208	79,182	21,790	46,138	19,139	78,264	21,460	45,956	17,338	73,134	21,200	38,483
1,5	18,0	23,050	95,041	26,155	55,379	22,963	93,887	25,740	55,149	21,957	91,702	25,839	50,917

TABELLA DI PORTATA S/C 2000: ACCIAIO S 250 GD / LOAD TABLE S/C 2000: STEEL S 250 GD

I valori di portata in tabella non includono il peso proprio della lamiera grecata.
The capacity load shown in the table does not include the weight of the metal sheet itself.

TABELLA DI PORTATA S/C 2000 ROVESCIO: ACCIAIO S 250 GD / LOAD TABLE S/C 2000 REVERSE POSITION: STEEL S 250 GD																				
Appoggio esterno 100 mm; appoggio interno (non presente) / End support 100 mm; internal support (not present)																				
Coefficienti di sicurezza sulle portate allo SLU (γ_q): 1,40 / Safety coefficient applied to SLU (γ_q): 1,40																				
PORTATA DEL PROFILO IN daN/m ² CON FRECCIA \leq L/180 max 20mm; L/200; L/250; L/300 / SHEET CAPACITY, daN/m ² WITH DEFLECTION \leq L/180 max 20mm; L/200; L/250; L/300 OF A SPAN																				
Spessore / thickness	(q) CARICO LIMITE LIMIT DESIGN DEFLECTION	 Distanza tra gli appoggi "L" in metri / Pitch "L" in metres between the supports																		
		freccia / deflection	1,50	1,75	2,00	2,25	2,50	2,75	3,00	3,25	3,50	3,75	4,00	4,25	4,50	4,75	5,00	5,25	5,50	5,75
0,60	q lim SLU	591	434	332	263	213	176	148	126	109	95	83	74	66	59	53	48	44	40	37
	q lim (L/180*)	591	434	332	263	209	157	121	95	76	59	46	36	29	23	19	15	-	-	-
	q lim (L/200)	591	434	332	258	188	141	109	86	69	56	46	38	32	27	24	20	18	-	-
	q lim (L/250)	591	434	294	206	150	113	87	68	55	45	37	31	26	22	19	16	14	-	-
	q lim (L/300)	580	365	245	172	125	94	73	57	46	37	31	26	21	18	16	14	12	-	-
0,80	q lim SLU	847	623	477	377	305	252	212	181	156	136	119	106	94	85	76	69	63	58	53
	q lim (L/180*)	847	623	477	377	293	220	170	133	107	83	64	51	40	32	26	22	18	-	-
	q lim (L/200)	847	623	477	362	264	198	153	120	96	78	64	54	45	38	33	28	25	22	-
	q lim (L/250)	847	615	412	289	211	158	122	96	77	63	52	43	36	31	26	23	20	17	-
	q lim (L/300)	814	513	343	241	176	132	102	80	64	52	43	36	30	26	22	19	17	14	-
1,00	q lim SLU	1142	839	642	507	411	340	285	243	210	183	161	142	127	114	103	93	85	78	71
	q lim (L/180*)	1142	839	642	507	370	278	214	169	135	105	81	64	51	41	33	27	23	19	-
	q lim (L/200)	1142	839	642	457	333	250	193	152	121	99	81	68	57	49	42	36	31	27	-
	q lim (L/250)	1142	777	521	366	267	200	154	121	97	79	65	54	46	39	33	29	25	22	-
	q lim (L/300)	1028	648	434	305	222	167	129	101	81	66	54	45	38	32	28	24	21	18	-
1,25	q lim SLU	1449	1064	815	644	521	431	362	309	266	232	204	180	161	144	130	118	108	99	91
	q lim (L/180*)	1449	1064	815	635	463	348	268	211	169	132	102	80	63	51	42	34	28	24	-
	q lim (L/200)	1449	1064	814	571	417	313	241	190	152	123	102	85	71	61	52	45	39	34	-
	q lim (L/250)	1449	972	651	457	333	250	193	152	121	99	81	68	57	49	42	36	31	27	-
	q lim (L/300)	1286	810	542	381	278	209	161	126	101	82	68	57	48	40	35	30	26	23	-
1,50	q lim SLU	1764	1296	992	784	635	525	441	376	324	282	248	220	196	176	159	144	131	120	110
	q lim (L/180*)	1764	1296	992	762	556	417	322	253	202	158	122	96	76	61	50	41	34	29	-
	q lim (L/200)	1764	1296	977	686	500	376	289	228	182	148	122	102	86	73	63	54	47	41	-
	q lim (L/250)	1764	1166	781	549	400	301	231	182	146	119	98	81	69	58	50	43	38	33	-
	q lim (L/300)	1543	972	651	457	333	250	193	152	121	99	81	68	57	49	42	36	31	27	-

LEGENDA / INDEX

Valori carico ammissibile uniformemente distribuito Distributed load and resistance factor design	>	Per la condizione di Stato Limite Ultimo (SLU) della lamiera / <i>Ultimate limit-state design of the corrugated sheet (SLU)</i>
	>	Per la condizione di Stato Limite di Esercizio (SLE) della lamiera ($F \leq$ L/180; L/200; L/250; L/300) / <i>Serviceability limit of the corrugated sheet (SLE) ($F \leq$ L/180; L/200; L/250; L/300)</i>
	>	Per la condizione di Stato Limite di Esercizio (SLE) della lamiera ($F \leq$ *solo max 20mm) / <i>Serviceability limit of the corrugated sheet (SLE) ($F \leq$ only max 20mm)</i>

I rapporti di prova pubblicati in questo catalogo vengono forniti a titolo puramente indicativo. I dati pubblicati sono stati calcolati secondo le Norme vigenti: NTC2018, Circolare esplicativa alle NTC2018, UNI EN 1993 (EC3). Per una corretta applicazione del prodotto sarà onere e cura del cliente e/o del progettista la redazione di calcoli appropriati con specifico riferimento al singolo impiego.

The test reports published in this catalogue are provided for indicative purposes only. The published data have been calculated according to the current regulations: NTC2018, Explanatory circular to NTC2018, UNI EN 1993 (EC3). For a correct application of the product, it will be responsibility and care of the customer and/or the designer to draw up appropriate calculations with specific reference to the individual use.

TABELLA DI PORTATA S/C 2000: ACCIAIO S 250 GD / LOAD TABLE S/C 2000: STEEL S 250 GD

I valori di portata in tabella non includono il peso proprio della lamiera grecata.
The capacity load shown in the table does not include the weight of the metal sheet itself.

TABELLA DI PORTATA S/C 2000 ROVESCIO: ACCIAIO S 250 GD / LOAD TABLE S/C 2000 REVERSE POSITION: STEEL S 250 GD																				
Appoggio esterno 100 mm; appoggio interno 100 mm / End support 100 mm; internal support 100 mm																				
Coefficienti di sicurezza sulle portate allo SLU (γ_q): 1,40 / Safety coefficient applied to SLU (γ_q): 1,40																				
PORTATA DEL PROFILO IN daN/m ² CON FRECCIA \leq L/180 max 20mm; L/200; L/250; L/300 / SHEET CAPACITY, daN/m ² WITH DEFLECTION \leq L/180 max 20mm; L/200; L/250; L/300 OF A SPAN																				
Spessore / thickness	(q) CARICO LIMITE LIMIT DESIGN DEFLECTION																			
		Distanza tra gli appoggi "L" in metri / Pitch "L" in metres between the supports																		
mm	freccia / deflection	1,50	1,75	2,00	2,25	2,50	2,75	3,00	3,25	3,50	3,75	4,00	4,25	4,50	4,75	5,00	5,25	5,50	5,75	6,00
0,60	q lim SLU	467	361	288	235	196	166	142	123	106	92	81	72	64	58	52	47	43	39	36
	q lim (L/180*)	467	361	288	235	196	166	142	123	106	92	81	72	64	56	46	38	31	26	22
	q lim (L/200)	467	361	288	235	196	166	142	123	106	92	81	72	64	58	52	47	43	38	33
	q lim (L/250)	467	361	288	235	196	166	142	123	106	92	81	72	63	53	46	40	34	30	27
	q lim (L/300)	467	361	288	235	196	166	142	123	106	91	75	62	52	45	38	33	29	25	22
0,80	q lim SLU	683	525	417	339	281	237	199	170	146	128	112	99	89	79	72	65	59	54	50
	q lim (L/180*)	683	525	417	339	281	237	199	170	146	128	112	99	89	79	64	53	44	37	31
	q lim (L/200)	683	525	417	339	281	237	199	170	146	128	112	99	89	79	72	65	59	53	47
	q lim (L/250)	683	525	417	339	281	237	199	170	146	128	112	99	88	75	64	56	48	42	37
	q lim (L/300)	683	525	417	339	281	237	199	170	146	127	105	87	73	62	54	46	40	35	31
1,00	q lim SLU	994	764	605	492	407	340	285	243	210	183	161	142	127	114	103	93	85	78	71
	q lim (L/180*)	994	764	605	492	407	340	285	243	210	183	161	142	124	100	81	67	55	46	39
	q lim (L/200)	994	764	605	492	407	340	285	243	210	183	161	142	127	114	102	88	76	67	59
	q lim (L/250)	994	764	605	492	407	340	285	243	210	183	159	132	111	95	81	70	61	53	47
	q lim (L/300)	994	764	605	492	407	340	285	243	197	160	132	110	93	79	68	58	51	45	39
1,25	q lim SLU	1318	1007	795	644	521	431	362	309	266	232	204	180	161	144	130	118	108	99	91
	q lim (L/180*)	1318	1007	795	644	521	431	362	309	266	232	204	180	155	125	102	84	69	58	49
	q lim (L/200)	1318	1007	795	644	521	431	362	309	266	232	204	180	161	144	127	110	95	83	73
	q lim (L/250)	1318	1007	795	644	521	431	362	309	266	232	198	165	139	118	102	88	76	67	59
	q lim (L/300)	1318	1007	795	644	521	431	362	308	247	201	165	138	116	99	85	73	64	56	49
1,50	q lim SLU	1657	1262	992	784	635	525	441	376	324	282	248	220	196	176	159	144	131	120	110
	q lim (L/180*)	1657	1262	992	784	635	525	441	376	324	282	248	220	186	150	122	100	83	70	59
	q lim (L/200)	1657	1262	992	784	635	525	441	376	324	282	248	220	196	176	152	132	114	100	88
	q lim (L/250)	1657	1262	992	784	635	525	441	376	324	282	238	199	167	142	122	105	92	80	71
	q lim (L/300)	1657	1262	992	784	635	525	441	370	296	241	198	165	139	118	102	88	76	67	59

LEGENDA / INDEX

Valori carico ammissibile uniformemente distribuito Distributed load and resistance factor design	>	Per la condizione di Stato Limite Ultimo (SLU) della lamiera / <i>Ultimate limit-state design of the corrugated sheet (SLU)</i>
	>	Per la condizione di Stato Limite di Esercizio (SLE) della lamiera ($F \leq$ L/180; L/200; L/250; L/300) / <i>Serviceability limit of the corrugated sheet (SLE) ($F \leq$ L/180; L/200; L/250; L/300)</i>
	>	Per la condizione di Stato Limite di Esercizio (SLE) della lamiera ($F \leq$ *solo max 20mm) / <i>Serviceability limit of the corrugated sheet (SLE) ($F \leq$ only max 20mm)</i>

I rapporti di prova pubblicati in questo catalogo vengono forniti a titolo puramente indicativo. I dati pubblicati sono stati calcolati secondo le Norme vigenti: NTC2018, Circolare esplicativa alle NTC2018, UNI EN 1993 (EC3). Per una corretta applicazione del prodotto sarà onere e cura del cliente e/o del progettista la redazione di calcoli appropriati con specifico riferimento al singolo impiego.

The test reports published in this catalogue are provided for indicative purposes only. The published data have been calculated according to the current regulations: NTC2018, Explanatory circular to NTC2018, UNI EN 1993 (EC3). For a correct application of the product, it will be responsibility and care of the customer and/or the designer to draw up appropriate calculations with specific reference to the individual use.

TABELLA DI PORTATA S/C 2000: ACCIAIO S 250 GD / LOAD TABLE S/C 2000: STEEL S 250 GD

I valori di portata in tabella non includono il peso proprio della lamiera grecata.
The capacity load shown in the table does not include the weight of the metal sheet itself.

TABELLA DI PORTATA S/C 2000 ROVESCIO: ACCIAIO S 250 GD / LOAD TABLE S/C 2000 REVERSE POSITION: STEEL S 250 GD																				
Appoggio esterno 100 mm; appoggio interno 100 mm / End support 100 mm; internal support 100 mm																				
Coefficienti di sicurezza sulle portate allo SLU (γ_q): 1,40 / Safety coefficient applied to SLU (γ_q): 1,40																				
PORTATA DEL PROFILO IN daN/m ² CON FRECCIA \leq L/180 max 20mm; L/200; L/250; L/300 / SHEET CAPACITY, daN /m ² WITH DEFLECTION \leq L/180 max 20mm; L/200; L/250; L/300 OF A SPAN																				
Spessore / thickness	(q) CARICO LIMITE LIMIT DESIGN DEFLECTION	 Distanza tra gli appoggi "L" in metri / Pitch "L" in metres between the supports																		
		freccia / deflection	1,50	1,75	2,00	2,25	2,50	2,75	3,00	3,25	3,50	3,75	4,00	4,25	4,50	4,75	5,00	5,25	5,50	5,75
0,60	q lim SLU	564	438	350	286	239	202	174	151	132	115	102	90	80	72	65	59	54	49	45
	q lim (L/180*)	564	438	350	286	239	202	174	151	132	114	88	69	55	44	36	30	25	21	17
	q lim (L/200)	564	438	350	286	239	202	174	151	131	107	88	73	62	52	45	39	34	30	26
	q lim (L/250)	564	438	350	286	239	202	167	131	105	85	70	59	49	42	36	31	27	24	21
	q lim (L/300)	564	438	350	286	239	180	139	109	87	71	59	49	41	35	30	26	23	20	17
0,80	q lim SLU	827	638	508	414	344	290	249	212	183	159	140	124	111	99	90	81	74	68	62
	q lim (L/180*)	827	638	508	414	344	290	249	212	183	159	123	97	77	62	50	42	34	29	24
	q lim (L/200)	827	638	508	414	344	290	249	212	183	150	123	103	87	74	63	55	47	42	37
	q lim (L/250)	827	638	508	414	344	290	234	184	147	120	99	82	69	59	50	44	38	33	29
	q lim (L/300)	827	638	508	414	337	253	195	153	123	100	82	69	58	49	42	36	32	28	24
1,00	q lim SLU	1206	929	738	601	499	421	357	304	262	228	201	178	159	142	128	117	106	97	89
	q lim (L/180*)	1206	929	738	601	499	421	357	304	258	202	156	122	97	78	64	52	44	36	31
	q lim (L/200)	1206	929	738	601	499	421	357	290	233	189	156	130	109	93	80	69	60	52	46
	q lim (L/250)	1206	929	738	601	499	383	295	232	186	151	125	104	88	74	64	55	48	42	37
	q lim (L/300)	1206	929	738	583	425	320	246	194	155	126	104	87	73	62	53	46	40	35	31
1,25	q lim SLU	1603	1229	973	789	652	539	453	386	333	290	255	226	201	181	163	148	135	123	113
	q lim (L/180*)	1603	1229	973	789	652	539	453	386	323	252	195	153	122	98	80	66	54	46	38
	q lim (L/200)	1603	1229	973	789	652	539	453	363	291	236	195	162	137	116	100	86	75	66	58
	q lim (L/250)	1603	1229	973	789	638	479	369	290	233	189	156	130	109	93	80	69	60	52	46
	q lim (L/300)	1603	1229	973	729	532	400	308	242	194	158	130	108	91	78	66	57	50	44	38
1,50	q lim SLU	2021	1543	1218	980	794	656	551	470	405	353	310	275	245	220	198	180	164	150	138
	q lim (L/180*)	2021	1543	1218	980	794	656	551	470	388	303	234	183	146	118	96	79	65	55	46
	q lim (L/200)	2021	1543	1218	980	794	656	551	436	349	284	234	195	164	140	120	103	90	79	69
	q lim (L/250)	2021	1543	1218	980	766	575	443	349	279	227	187	156	131	112	96	83	72	63	55
	q lim (L/300)	2021	1543	1218	876	638	480	369	291	233	189	156	130	109	93	80	69	60	52	46
LEGENDA / INDEX																				
Valori carico ammissibile uniformemente distribuito <i>Distributed load and resistance factor design</i>	>	Per la condizione di Stato Limite Ultimo (SLU) della lamiera / <i>Ultimate limit-state design of the corrugated sheet (SLU)</i>																		
	>	Per la condizione di Stato Limite di Esercizio (SLE) della lamiera ($F \leq$ L/180; L/200; L/250; L/300) / <i>Serviceability limit of the corrugated sheet (SLE) ($F \leq$ L/180; L/200; L/250; L/300)</i>																		
	>	Per la condizione di Stato Limite di Esercizio (SLE) della lamiera ($F \leq$ *solo max 20mm) / <i>Serviceability limit of the corrugated sheet (SLE) ($F \leq$ only max 20mm)</i>																		

LAMIERE DA SOLAIO
SLAB CORRUGATED SHEETS

I rapporti di prova pubblicati in questo catalogo vengono forniti a titolo puramente indicativo. I dati pubblicati sono stati calcolati secondo le Norme vigenti: NTC2018, Circolare esplicativa alle NTC2018, UNI EN 1993 (EC3). Per una corretta applicazione del prodotto sarà onere e cura del cliente e/o del progettista la redazione di calcoli appropriati con specifico riferimento al singolo impiego.

The test reports published in this catalogue are provided for indicative purposes only. The published data have been calculated according to the current regulations: NTC2018, Explanatory circular to NTC2018, UNI EN 1993 (EC3). For a correct application of the product, it will be responsibility and care of the customer and/or the designer to draw up appropriate calculations with specific reference to the individual use.

R/C 400 / LAMIERA DA SOLAIO - SLAB CORRUGATED SHEET



CLASSE / CLASS

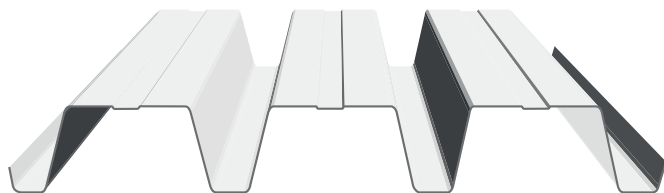

R/C 400 Deck è una lamiera grecata da solaio con greca alta e passo stretto, ideale per solai di edifici storici, grazie alla sua sezione contenuta. Disponibile anche in versione AM utilizzata come casseratura (cassaforma) a perdere, per gettata in calcestruzzo armato.

R/C 400 Deck is a corrugated metal sheet for floor with high ribs and narrow pitches ideal for floors of historic buildings thanks to its small section. Also available in the AM version used as disposable formwork for casting in reinforced concrete.

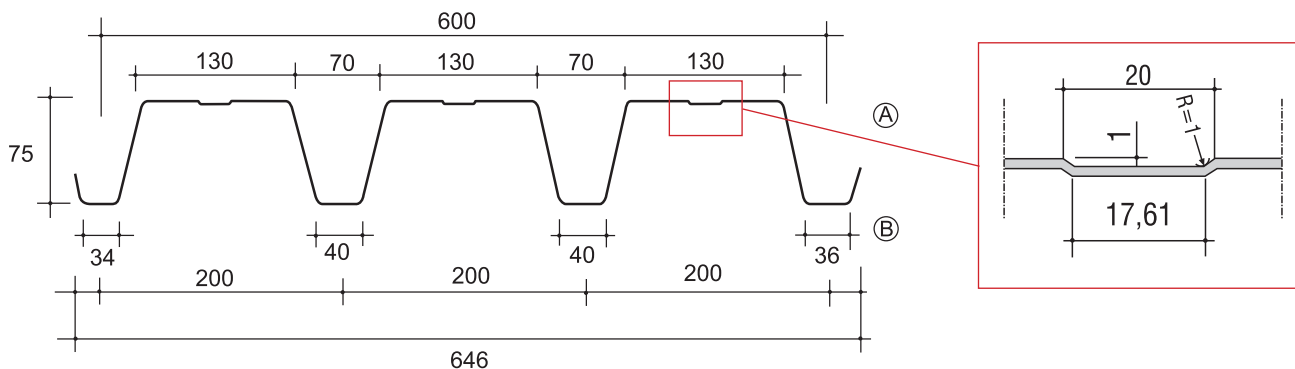

Nei disegni, A o B indicano il lato preverniciato desiderato.
In the drawings A or B show the wished pre-painted side.

Nome del prodotto Product name	Numero greche Number of ribs	Interasse greche Pitch	Altezza greca Rib height	Larghezza greca Rib width	Base greca Rib long base	Larghezza modulo Covering width	Numero greche di sormonto Rib overlap
	(nr)	(mm)	(mm)	(mm)	(mm)	(mm)	(nr)
R/C 400	4	200	75	40	70	600	1

Caratteristiche tecniche - Datasheet

Dimensioni: larghezza 600 (mm), lunghezza a richiesta da produzione in continuo.

Spessori: fino a mm 1,5 - anche non standard su richiesta.

Alcune tipologie di acciaio, fornibili a richiesta previo accordo sui quantitativi minimi: S 235; S 250 GD+Z; S 260 NC; S 275; S 280 GD+Z; S 315 MC; S 315 NC; S 320 GD+Z (ed altri ancora).

Supporti: acciaio zincato preverniciato o plastificato;
Trattamenti protettivi applicabili a richiesta: Preverniciatura con poliestere, superpoliestere (hd) Disponibilità su richiesta di altri film e rivestimenti.

Dimensions: width 600 (mm), length upon request from continuous production process.

Thicknesses (S): up to mm 1,5 - also non-standard on request.

Some types of steel supplied upon request previous agreement on minimum quantities: S 235; S 250 GD+Z; S 260 NC; S 275; S 280 GD+Z; S 315 MC; S 315 NC; S 320 GD+Z (and others more).

Supports: pre-painted or plasticized galvanized steel;
Protective treatments for external support available on request: Pre-painting with polyester, superpolyester (hd). Availability on request of other films and coatings.

R/C 400 DECK - ACCIAIO S 250 GD+Z / STEEL S 250 GD+Z CARATTERISTICHE STATICHE / STATIC CHARACTERISTICS													
spessore lamiera - sheet metal thickness	Peso weight (passo) 600 mm	PROPRIETA' DI MASSA LORDE: GROSS MASS PROPERTY:				PROPRIETA' DI MASSA EFFICACI: - EFFECTIVE MASS PROPERTIES:							
						MOMENTO POSITIVO IN CAMPATA POSITIVE MOMENT ON SPAN				MOMENTO NEGATIVO SULL'APPOGGIO NEGATIVE MOMENT ON SUPPORT			
		A	J _{xG}	W _{e sup}	W _{e inf}	A _{eff}	J _{xG eff}	W _{e sup eff}	W _{e inf eff}	A _{eff}	J _{xG eff}	W _{e sup eff}	W _{e inf eff}
		[kg/m ²]	cm ² /m	cm ⁴ /m	cm ³ /m	cm ² /m	cm ⁴ /m	cm ³ /m	cm ³ /m	cm ² /m	cm ⁴ /m	cm ³ /m	cm ³ /m
0,6	8,1	9,638	78,495	29,795	16,682	7,211	56,319	16,025	14,722	8,214	61,078	29,047	11,662
0,8	10,5	12,851	104,665	39,728	22,243	10,176	81,602	24,569	20,305	12,253	95,817	38,991	19,624
1,0	13,1	16,064	130,840	49,664	27,806	13,368	108,770	34,413	26,026	15,964	128,609	49,370	27,161
1,25	16,4	20,080	163,567	62,086	34,761	17,633	144,650	48,282	33,299	20,020	162,226	61,910	34,372
1,5	19,4	24,096	196,304	74,512	41,718	22,093	181,547	63,256	40,615	24,020	194,619	74,291	41,230

TABELLA DI PORTATA R/C 400: ACCIAIO S 250 GD / LOAD TABLE R/C 400: STEEL S 250 GD

I valori di portata in tabella non includono il peso proprio della lamiera grecata.
The capacity load shown in the table does not include the weight of the metal sheet itself.

TABELLA DI PORTATA R/C 400 DECK: ACCIAIO S 250 GD / LOAD TABLE R/C 400 DECK: STEEL S 250 GD																				
Appoggio esterno 100 mm; appoggio interno (non presente) / End support 100 mm; internal support (not present)																				
Coefficienti di sicurezza sulle portate allo SLU (γ_q): 1,40 / Safety coefficient applied to SLU (γ_q): 1,40																				
PORTATA DEL PROFILO IN daN/m ² CON FRECCIA \leq L/180 max 20mm; L/200; L/250; L/300 / SHEET CAPACITY, daN/m ² WITH DEFLECTION \leq L/180 max 20mm; L/200; L/250; L/300 OF A SPAN																				
Spessore / thickness	(q) CARICO LIMITE LIMIT DESIGN DEFLECTION																			
		Distanza tra gli appoggi "L" in metri / Pitch "L" in metres between the supports																		
mm	freccia / deflection	1,50	1,75	2,00	2,25	2,50	2,75	3,00	3,25	3,50	3,75	4,00	4,25	4,50	4,75	5,00	5,25	5,50	5,75	6,00
0,60	q lim SLU	503	431	378	336	302	270	227	193	167	145	128	113	101	90	82	74	67	62	57
	q lim (L/180*)	503	431	378	336	302	247	191	150	120	94	72	57	45	36	30	24	20	-	-
	q lim (L/200)	503	431	378	336	296	223	171	135	108	88	72	60	51	43	37	32	28	24	-
	q lim (L/250)	503	431	378	325	237	178	137	108	86	70	58	48	41	35	30	26	22	19	-
	q lim (L/300)	503	431	378	271	198	148	114	90	72	59	48	40	34	29	25	21	19	16	-
0,80	q lim SLU	855	733	642	556	451	372	313	267	230	200	176	156	139	125	113	102	93	85	78
	q lim (L/180*)	855	733	642	556	451	358	276	217	174	136	105	82	65	53	43	35	29	25	-
	q lim (L/200)	855	733	642	556	429	323	248	195	156	127	105	87	74	63	54	46	40	35	-
	q lim (L/250)	855	733	642	471	343	258	199	156	125	102	84	70	59	50	43	37	32	28	-
	q lim (L/300)	855	733	559	393	286	215	166	130	104	85	70	58	49	42	36	31	27	24	-
1,00	q lim SLU	1291	1107	902	713	578	477	401	342	295	257	226	200	178	160	144	131	119	109	100
	q lim (L/180*)	1291	1107	902	713	578	477	368	289	232	181	140	110	87	70	57	47	39	33	-
	q lim (L/200)	1291	1107	902	713	572	430	331	260	209	170	140	116	98	83	72	62	54	47	-
	q lim (L/250)	1291	1107	894	628	458	344	265	208	167	136	112	93	78	67	57	49	43	38	-
	q lim (L/300)	1291	1107	745	523	381	287	221	174	139	113	93	78	65	56	48	41	36	31	-
1,25	q lim SLU	2017	1684	1289	1019	825	682	573	488	421	367	322	286	255	229	206	187	170	156	143
	q lim (L/180*)	2017	1684	1289	1019	825	682	553	435	348	272	210	165	131	106	86	71	59	49	-
	q lim (L/200)	2017	1684	1289	1019	825	647	498	392	314	255	210	175	148	125	108	93	81	71	-
	q lim (L/250)	2017	1684	1289	944	688	517	398	313	251	204	168	140	118	100	86	74	65	57	-
	q lim (L/300)	2017	1673	1120	787	574	431	332	261	209	170	140	117	98	84	72	62	54	47	-
1,50	q lim SLU	2787	2047	1567	1239	1003	829	697	594	512	446	392	347	310	278	251	227	207	190	174
	q lim (L/180*)	2787	2047	1567	1239	1003	829	664	522	418	326	252	198	157	127	103	85	71	59	-
	q lim (L/200)	2787	2047	1567	1239	1003	776	598	470	376	306	252	210	177	151	129	112	97	85	-
	q lim (L/250)	2787	2047	1567	1133	826	621	478	376	301	245	202	168	142	120	103	89	78	68	-
	q lim (L/300)	2787	2007	1345	944	688	517	398	313	251	204	168	140	118	100	86	74	65	57	-
LEGENDA / INDEX																				
Valori carico ammissibile uniformemente distribuito Distributed load and resistance factor design	>	Per la condizione di Stato Limite Ultimo (SLU) della lamiera / <i>Ultimate limit-state design of the corrugated sheet (SLU)</i>																		
	>	Per la condizione di Stato Limite di Esercizio (SLE) della lamiera ($F \leq$ L/180; L/200; L/250; L/300) / <i>Serviceability limit of the corrugated sheet (SLE) ($F \leq$ L/180; L/200; L/250; L/300)</i>																		
	>	Per la condizione di Stato Limite di Esercizio (SLE) della lamiera ($F \leq$ *solo max 20mm) / <i>Serviceability limit of the corrugated sheet (SLE) ($F \leq$ only max 20mm)</i>																		

LAMIERE DA SOLAIO
SLAB CORRUGATED SHEETS

I rapporti di prova pubblicati in questo catalogo vengono forniti a titolo puramente indicativo. I dati pubblicati sono stati calcolati secondo le Norme vigenti: NTC2018, Circolare esplicativa alle NTC2018, UNI EN 1993 (EC3). Per una corretta applicazione del prodotto sarà onere e cura del cliente e/o del progettista la redazione di calcoli appropriati con specifico riferimento al singolo impiego.

The test reports published in this catalogue are provided for indicative purposes only. The published data have been calculated according to the current regulations: NTC2018, Explanatory circular to NTC2018, UNI EN 1993 (EC3). For a correct application of the product, it will be responsibility and care of the customer and/or the designer to draw up appropriate calculations with specific reference to the individual use.

TABELLA DI PORTATA R/C 400: ACCIAIO S 250 GD / LOAD TABLE R/C 400: STEEL S 250 GD

I valori di portata in tabella non includono il peso proprio della lamiera grecata.
The capacity load shown in the table does not include the weight of the metal sheet itself.

TABELLA DI PORTATA R/C 400 DECK: ACCIAIO S 250 GD / LOAD TABLE R/C 400 DECK: STEEL S 250 GD																				
Appoggio esterno 100 mm; appoggio interno 100 mm / End support 100 mm; internal support 100 mm																				
Coefficients di sicurezza sulle portate allo SLU (γ_q): 1,40 / Safety coefficient applied to SLU (γ_q): 1,40																				
PORTATA DEL PROFILO IN daN/m ² CON FRECCIA \leq L/180 max 20mm; L/200; L/250; L/300 / SHEET CAPACITY, daN /m ² WITH DEFLECTION \leq L/180 max 20mm; L/200; L/250; L/300 OF A SPAN																				
Spessore / thickness	(q) CARICO LIMITE LIMIT DESIGN DEFLECTION	 Distanza tra gli appoggi "L" in metri / Pitch "L" in metres between the supports																		
		freccia / deflection	1,50	1,75	2,00	2,25	2,50	2,75	3,00	3,25	3,50	3,75	4,00	4,25	4,50	4,75	5,00	5,25	5,50	5,75
0,60	q lim SLU	492	386	312	257	216	184	159	139	122	108	96	87	78	71	65	59	53	49	45
	q lim (L/180*)	492	386	312	257	216	184	159	139	122	108	96	87	78	71	65	59	49	41	35
	q lim (L/200)	492	386	312	257	216	184	159	139	122	108	96	87	78	71	65	59	53	49	45
	q lim (L/250)	492	386	312	257	216	184	159	139	122	108	96	87	78	71	65	59	53	47	42
	q lim (L/300)	492	386	312	257	216	184	159	139	122	108	96	87	78	70	60	52	45	40	35
0,80	q lim SLU	818	643	520	429	361	307	265	231	204	181	161	145	131	119	108	99	90	82	76
	q lim (L/180*)	818	643	520	429	361	307	265	231	204	181	161	145	131	119	105	86	71	60	50
	q lim (L/200)	818	643	520	429	361	307	265	231	204	181	161	145	131	119	108	99	90	82	76
	q lim (L/250)	818	643	520	429	361	307	265	231	204	181	161	145	131	119	105	90	79	69	61
	q lim (L/300)	818	643	520	429	361	307	265	231	204	181	161	142	120	102	87	75	66	57	50
1,00	q lim SLU	1161	911	735	606	509	433	373	325	286	254	226	203	183	167	151	137	125	114	105
	q lim (L/180*)	1161	911	735	606	509	433	373	325	286	254	226	203	183	167	140	115	95	80	67
	q lim (L/200)	1161	911	735	606	509	433	373	325	286	254	226	203	183	167	151	137	125	114	101
	q lim (L/250)	1161	911	735	606	509	433	373	325	286	254	226	203	183	163	140	121	105	92	81
	q lim (L/300)	1161	911	735	606	509	433	373	325	286	254	226	189	159	136	116	100	87	76	67
1,25	q lim SLU	1662	1299	1044	859	719	611	526	457	402	355	317	284	255	229	206	187	170	156	143
	q lim (L/180*)	1662	1299	1044	859	719	611	526	457	402	355	317	284	255	229	206	173	143	120	101
	q lim (L/200)	1662	1299	1044	859	719	611	526	457	402	355	317	284	255	229	206	187	170	156	143
	q lim (L/250)	1662	1299	1044	859	719	611	526	457	402	355	317	284	255	229	206	181	158	138	121
	q lim (L/300)	1662	1299	1044	859	719	611	526	457	402	355	317	284	240	204	175	151	131	115	101
1,50	q lim SLU	2124	1653	1324	1085	906	768	660	573	502	444	392	347	310	278	251	227	207	190	174
	q lim (L/180*)	2124	1653	1324	1085	906	768	660	573	502	444	392	347	310	278	251	207	172	144	121
	q lim (L/200)	2124	1653	1324	1085	906	768	660	573	502	444	392	347	310	278	251	227	207	190	174
	q lim (L/250)	2124	1653	1324	1085	906	768	660	573	502	444	392	347	310	278	251	218	189	166	146
	q lim (L/300)	2124	1653	1324	1085	906	768	660	573	502	444	392	342	288	245	210	181	158	138	121

LEGENDA / INDEX

Valori carico ammissibile uniformemente distribuito Distributed load and resistance factor design	>	Per la condizione di Stato Limite Ultimo (SLU) della lamiera / <i>Ultimate limit-state design of the corrugated sheet (SLU)</i>
	>	Per la condizione di Stato Limite di Esercizio (SLE) della lamiera ($F \leq$ L/180; L/200; L/250; L/300) / <i>Serviceability limit of the corrugated sheet (SLE) ($F \leq$ L/180; L/200; L/250; L/300)</i>
	>	Per la condizione di Stato Limite di Esercizio (SLE) della lamiera ($F \leq$ *solo max 20mm) / <i>Serviceability limit of the corrugated sheet (SLE) ($F \leq$ only max 20mm)</i>

I rapporti di prova pubblicati in questo catalogo vengono forniti a titolo puramente indicativo. I dati pubblicati sono stati calcolati secondo le Norme vigenti: NTC2018, Circolare esplicativa alle NTC2018, UNI EN 1993 (EC3). Per una corretta applicazione del prodotto sarà onere e cura del cliente e/o del progettista la redazione di calcoli appropriati con specifico riferimento al singolo impiego.

The test reports published in this catalogue are provided for indicative purposes only. The published data have been calculated according to the current regulations: NTC2018, Explanatory circular to NTC2018, UNI EN 1993 (EC3). For a correct application of the product, it will be responsibility and care of the customer and/or the designer to draw up appropriate calculations with specific reference to the individual use.

TABELLA DI PORTATA R/C 400: ACCIAIO S 250 GD / LOAD TABLE R/C 400: STEEL S 250 GD

I valori di portata in tabella non includono il peso proprio della lamiera grecata.
The capacity load shown in the table does not include the weight of the metal sheet itself.

TABELLA DI PORTATA R/C 400 DECK: ACCIAIO S 250 GD / LOAD TABLE R/C 400 DECK: STEEL S 250 GD																				
Appoggio esterno 100 mm; appoggio interno 100 mm / End support 100 mm; internal support 100 mm																				
Coefficienti di sicurezza sulle portate allo SLU (γ_q): 1,40 / Safety coefficient applied to SLU (γ_q): 1,40																				
PORTATA DEL PROFILO IN daN/m ² CON FRECCIA \leq L/180 max 20mm; L/200; L/250; L/300 / SHEET CAPACITY, daN /m ² WITH DEFLECTION \leq L/180 max 20mm; L/200; L/250; L/300 OF A SPAN																				
Spessore / thickness	(q) CARICO LIMITE LIMIT DESIGN DEFLECTION																			
		Distanza tra gli appoggi "L" in metri / Pitch "L" in metres between the supports																		
mm	freccia / deflection	1,50	1,75	2,00	2,25	2,50	2,75	3,00	3,25	3,50	3,75	4,00	4,25	4,50	4,75	5,00	5,25	5,50	5,75	6,00
0,60	q lim SLU	588	464	376	311	262	223	193	169	148	132	118	106	96	87	79	73	67	61	56
	q lim (L/180*)	588	464	376	311	262	223	193	169	148	132	118	106	86	70	57	47	39	32	27
	q lim (L/200)	588	464	376	311	262	223	193	169	148	132	118	106	96	83	71	61	53	47	41
	q lim (L/250)	588	464	376	311	262	223	193	169	148	132	111	92	78	66	57	49	43	37	33
	q lim (L/300)	588	464	376	311	262	223	193	169	138	112	92	77	65	55	47	41	36	31	27
0,80	q lim SLU	977	771	625	518	436	373	322	281	248	220	197	177	160	146	133	122	112	103	95
	q lim (L/180*)	977	771	625	518	436	373	322	281	248	220	197	157	125	101	82	68	56	47	40
	q lim (L/200)	977	771	625	518	436	373	322	281	248	220	197	167	141	120	103	89	77	68	59
	q lim (L/250)	977	771	625	518	436	373	322	281	240	195	161	134	113	96	82	71	62	54	48
	q lim (L/300)	977	771	625	518	436	373	317	249	200	162	134	112	94	80	69	59	51	45	40
1,00	q lim SLU	1390	1094	886	732	616	525	454	396	349	309	276	248	225	204	186	171	156	142	131
	q lim (L/180*)	1390	1094	886	732	616	525	454	396	349	309	268	210	167	135	110	90	75	63	53
	q lim (L/200)	1390	1094	886	732	616	525	454	396	349	309	268	223	188	160	137	118	103	90	79
	q lim (L/250)	1390	1094	886	732	616	525	454	396	319	260	214	178	150	128	110	95	82	72	63
	q lim (L/300)	1390	1094	886	732	616	525	423	332	266	216	178	149	125	106	91	79	69	60	53
1,25	q lim SLU	1993	1563	1261	1040	872	743	640	558	490	435	388	348	314	285	258	234	213	195	179
	q lim (L/180*)	1993	1563	1261	1040	872	743	640	558	490	435	388	316	251	202	165	136	113	94	79
	q lim (L/200)	1993	1563	1261	1040	872	743	640	558	490	435	388	335	283	240	206	178	155	135	119
	q lim (L/250)	1993	1563	1261	1040	872	743	640	558	480	391	322	268	226	192	165	142	124	108	95
	q lim (L/300)	1993	1563	1261	1040	872	743	636	500	400	325	268	224	188	160	137	119	103	90	79
1,50	q lim SLU	2555	1995	1603	1317	1102	936	805	700	614	544	484	434	387	347	313	284	259	237	218
	q lim (L/180*)	2555	1995	1603	1317	1102	936	805	700	614	544	483	379	301	243	198	163	135	113	95
	q lim (L/200)	2555	1995	1603	1317	1102	936	805	700	614	544	483	403	339	288	247	214	186	163	143
	q lim (L/250)	2555	1995	1603	1317	1102	936	805	700	577	469	386	322	271	231	198	171	149	130	114
	q lim (L/300)	2555	1995	1603	1317	1102	936	763	600	480	391	322	268	226	192	165	142	124	108	95

LEGENDA / INDEX

Valori carico ammissibile uniformemente distribuito Distributed load and resistance factor design	>	Per la condizione di Stato Limite Ultimo (SLU) della lamiera / <i>Ultimate limit-state design of the corrugated sheet (SLU)</i>
	>	Per la condizione di Stato Limite di Esercizio (SLE) della lamiera ($F \leq$ L/180; L/200; L/250; L/300) / <i>Serviceability limit of the corrugated sheet (SLE) ($F \leq$ L/180; L/200; L/250; L/300)</i>
	>	Per la condizione di Stato Limite di Esercizio (SLE) della lamiera ($F \leq$ *solo max 20mm) / <i>Serviceability limit of the corrugated sheet (SLE) ($F \leq$ only max 20mm)</i>

I rapporti di prova pubblicati in questo catalogo vengono forniti a titolo puramente indicativo. I dati pubblicati sono stati calcolati secondo le Norme vigenti: NTC2018, Circolare esplicativa alle NTC2018, UNI EN 1993 (EC3). Per una corretta applicazione del prodotto sarà onere e cura del cliente e/o del progettista la redazione di calcoli appropriati con specifico riferimento al singolo impiego.

The test reports published in this catalogue are provided for indicative purposes only. The published data have been calculated according to the current regulations: NTC2018, Explanatory circular to NTC2018, UNI EN 1993 (EC3). For a correct application of the product, it will be responsibility and care of the customer and/or the designer to draw up appropriate calculations with specific reference to the individual use.

E/S 4000 / LAMIERA DA SOLAIO - SLAB CORRUGATED SHEET



CLASSE / CLASS



Lamiera da solaio a secco, dai minimi ingombri, che coniuga leggerezza, praticità e rapidità di posa. Presenta un profilo quadro, ideale per solai a secco caratterizzati da spazi contenuti. E' disponibile anche nella versione AM per solai collaboranti.

Dry slab metal sheet, with minimal dimensions, which combines lightness, practicality and quick installation. It has a square profile, ideal for dry floors characterized by limited spaces. It is also available in the AM version for collaborating floors.

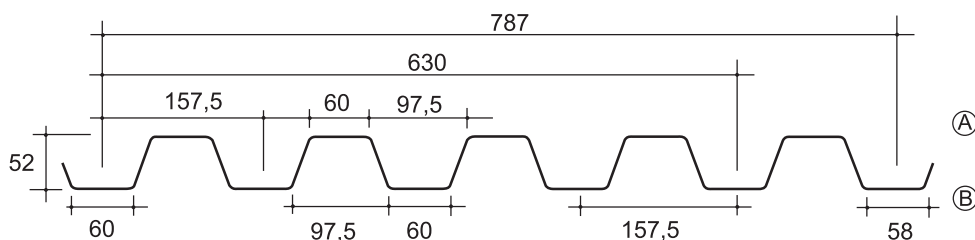

Nei disegni, A o B indicano il lato preverniciato desiderato.
In the drawings A or B show the wished pre-painted side.

Nome del prodotto Product name	Numero greche Number of ribs (nr)	Interasse greche Pitch (mm)	Altezza greca Rib height (mm)	Larghezza greca Rib width (mm)	Base greca Rib long base (mm)	Larghezza modulo Covering width (mm)	Numero greche di sormonto Rib overlap (nr)
E/S 4000	6	157,5	52	60	97,5	787	1

Caratteristiche tecniche - Datasheet

Dimensioni: larghezza 787,5 (mm), lunghezza a richiesta da produzione in continuo.

Spessori: fino a mm 1,5 - anche non standard su richiesta.

Alcune tipologie di acciaio, fornibili a richiesta previo accordo sui quantitativi minimi: S 235; S 250 GD+Z; S 260 NC; S 275; S 280 GD+Z; S 315 MC; S 315 NC; S 320 GD+Z (ed altri ancora).

Supporti: acciaio zincato preverniciato o plastificato;
Trattamenti protettivi applicabili a richiesta: Preverniciatura con poliestere, superpoliestere (hd) Disponibilità su richiesta di altri film e rivestimenti.

Dimensions: width 787,5 (mm), length upon request from continuous production process.

Thicknesses (S): up to mm 1,5 - also non-standard on request.

Some types of steel supplied upon request previous agreement on minimum quantities: S 235; S 250 GD+Z; S 260 NC; S 275; S 280 GD+Z; S 315 MC; S 315 NC; S 320 GD+Z (and others more).

Supports: pre-painted or plasticized galvanized steel;
Protective treatments for external support available on request: Pre-painting with polyester, superpolyester (hd). Availability on request of other films and coatings.

E/S 4000 - ACCIAIO S 250 GD+Z / STEEL S 250 GD+Z CARATTERISTICHE STATICHE / STATIC CHARACTERISTICS													
spessore lamiera - sheet metal thickness	Peso weight (passo) 787 mm	PROPRIETA' DI MASSA LORDE: GROSS MASS PROPERTY:				PROPRIETA' DI MASSA EFFICACI: - EFFECTIVE MASS PROPERTIES:							
						MOMENTO POSITIVO IN CAMPATA POSITIVE MOMENT ON SPAN				MOMENTO NEGATIVO SULL'APPOGGIO NEGATIVE MOMENT ON SUPPORT			
		A	J _{xG}	W _{e sup}	W _{e inf}	A _{eff}	J _{xG eff}	W _{e sup eff}	W _{e inf eff}	A _{eff}	J _{xG eff}	W _{e sup eff}	W _{e inf eff}
		[kg/m ²]	cm ⁴ /m	cm ³ /m	cm ³ /m	cm ² /m	cm ⁴ /m	cm ³ /m	cm ³ /m	cm ² /m	cm ⁴ /m	cm ³ /m	cm ³ /m
0,6	7,4	8,855	42,134	15,900	15,900	7,685	32,670	10,700	14,541	7,674	32,563	14,523	10,649
0,8	9,9	11,806	56,183	21,201	21,201	10,647	47,154	16,047	19,968	10,631	47,018	19,947	15,977
1,0	12,3	14,758	70,236	26,504	26,504	13,752	62,652	22,030	25,509	13,731	62,485	25,485	21,939
1,25	15,4	18,447	87,809	33,136	33,136	17,781	82,953	30,172	32,522	17,754	82,749	32,495	30,052
1,5	18,5	22,137	105,392	39,771	39,771	21,912	103,797	38,771	39,575	21,878	103,553	39,544	38,620

TABELLA DI PORTATA E/S 4000: ACCIAIO S 250 GD / LOAD TABLE E/S 4000: STEEL S 250 GD

I valori di portata in tabella non includono il peso proprio della lamiera grecata.
The capacity load shown in the table does not include the weight of the metal sheet itself.

TABELLA DI PORTATA E/S 4000 NORMALE: ACCIAIO S 250 GD / LOAD TABLE E/S 4000 NORMAL POSITION: STEEL S 250 GD																				
Appoggio esterno 100 mm; appoggio interno (non presente) / End support 100 mm; internal support (not present)																				
Coefficienti di sicurezza sulle portate allo SLU (γ_q): 1,40 / Safety coefficient applied to SLU (γ_q): 1,40																				
PORTATA DEL PROFILO IN daN/m ² CON FRECCIA \leq L/180 max 20mm; L/200; L/250; L/300 / SHEET CAPACITY, daN/m ² WITH DEFLECTION \leq L/180 max 20mm; L/200; L/250; L/300 OF A SPAN																				
Spessore / thickness	(q) CARICO LIMITE LIMIT DESIGN DEFLECTION																			
		Distanza tra gli appoggi "L" in metri / Pitch "L" in metres between the supports																		
mm	freccia / deflection	1,50	1,75	2,00	2,25	2,50	2,75	3,00	3,25	3,50	3,75	4,00	4,25	4,50	4,75	5,00	5,25	5,50	5,75	6,00
0,60	q lim SLU	617	529	462	411	361	298	251	214	184	160	141	125	111	100	90	82	75	68	63
	q lim (L/180*)	617	529	462	338	246	185	143	112	90	70	54	42	34	27	22	18	15	-	-
	q lim (L/200)	617	529	433	304	222	167	128	101	81	66	54	45	38	32	28	24	21	18	-
	q lim (L/250)	617	517	346	243	177	133	103	81	65	53	43	36	30	26	22	19	17	15	-
	q lim (L/300)	617	431	289	203	148	111	86	67	54	44	36	30	25	22	18	16	14	12	-
0,80	q lim SLU	1052	902	758	599	485	401	337	287	247	216	189	168	150	134	121	110	100	92	84
	q lim (L/180*)	1052	902	641	451	328	247	190	149	120	93	72	57	45	36	30	24	20	17	-
	q lim (L/200)	1052	862	577	405	296	222	171	135	108	88	72	60	51	43	37	32	28	24	-
	q lim (L/250)	1052	689	462	324	236	178	137	108	86	70	58	48	41	34	30	26	22	19	-
	q lim (L/300)	912	574	385	270	197	148	114	90	72	58	48	40	34	29	25	21	19	16	-
1,00	q lim SLU	1594	1247	954	754	611	505	424	361	312	271	239	211	189	169	153	139	126	115	106
	q lim (L/180*)	1594	1197	802	563	411	308	238	187	150	117	90	71	56	45	37	30	25	21	-
	q lim (L/200)	1594	1077	722	507	370	278	214	168	135	109	90	75	63	54	46	40	35	30	-
	q lim (L/250)	1369	862	577	405	296	222	171	135	108	88	72	60	51	43	37	32	28	24	-
	q lim (L/300)	1140	718	481	338	246	185	143	112	90	73	60	50	42	36	31	27	23	20	-
1,25	q lim SLU	2141	1573	1204	952	771	637	535	456	393	343	301	267	238	213	193	175	159	146	134
	q lim (L/180*)	2141	1496	1003	704	513	386	297	234	187	146	113	88	70	57	46	38	32	26	-
	q lim (L/200)	2139	1347	902	634	462	347	267	210	168	137	113	94	79	67	58	50	43	38	-
	q lim (L/250)	1711	1077	722	507	370	278	214	168	135	110	90	75	63	54	46	40	35	30	-
	q lim (L/300)	1426	898	602	422	308	231	178	140	112	91	75	63	53	45	38	33	29	25	-
1,50	q lim SLU	2593	1905	1459	1153	934	772	648	552	476	415	365	323	288	259	233	212	193	176	162
	q lim (L/180*)	2593	1796	1203	845	616	463	357	280	225	175	135	106	85	68	55	46	38	32	-
	q lim (L/200)	2567	1616	1083	761	554	417	321	252	202	164	135	113	95	81	69	60	52	46	-
	q lim (L/250)	2054	1293	866	608	444	333	257	202	162	131	108	90	76	65	55	48	42	36	-
	q lim (L/300)	1711	1078	722	507	370	278	214	168	135	110	90	75	63	54	46	40	35	30	-
LEGENDA / INDEX																				
Valori carico ammissibile uniformemente distribuito <i>Distributed load and resistance factor design</i>	>	Per la condizione di Stato Limite Ultimo (SLU) della lamiera / <i>Ultimate limit-state design of the corrugated sheet (SLU)</i>																		
	>	Per la condizione di Stato Limite di Esercizio (SLE) della lamiera ($F \leq L/180; L/200; L/250; L/300$) / <i>Serviceability limit of the corrugated sheet (SLE) ($F \leq L/180; L/200; L/250; L/300$)</i>																		
	>	Per la condizione di Stato Limite di Esercizio (SLE) della lamiera ($F \leq$ *solo max 20mm) / <i>Serviceability limit of the corrugated sheet (SLE) ($F \leq$ only max 20mm)</i>																		

LAMIERE DA SOLAIO
SLAB CORRUGATED SHEETS

I rapporti di prova pubblicati in questo catalogo vengono forniti a titolo puramente indicativo. I dati pubblicati sono stati calcolati secondo le Norme vigenti: NTC2018, Circolare esplicativa alle NTC2018, UNI EN 1993 (EC3). Per una corretta applicazione del prodotto sarà onere e cura del cliente e/o del progettista la redazione di calcoli appropriati con specifico riferimento al singolo impiego.

The test reports published in this catalogue are provided for indicative purposes only. The published data have been calculated according to the current regulations: NTC2018, Explanatory circular to NTC2018, UNI EN 1993 (EC3). For a correct application of the product, it will be responsibility and care of the customer and/or the designer to draw up appropriate calculations with specific reference to the individual use.

TABELLA DI PORTATA E/S 4000: ACCIAIO S 250 GD / LOAD TABLE E/S 4000: STEEL S 250 GD

I valori di portata in tabella non includono il peso proprio della lamiera grecata.
The capacity load shown in the table does not include the weight of the metal sheet itself.

TABELLA DI PORTATA E/S 4000 NORMALE: ACCIAIO S 250 GD / LOAD TABLE E/S 4000 NORMAL POSITION: STEEL S 250 GD																				
Appoggio esterno 100 mm; appoggio interno 100 mm / End support 100 mm; internal support 100 mm																				
Coefficients di sicurezza sulle portate allo SLU (γ_q): 1,40 / Safety coefficient applied to SLU (γ_q): 1,40																				
PORTATA DEL PROFILO IN daN/m ² CON FRECCIA \leq L/180 max 20mm; L/200; L/250; L/300 / SHEET CAPACITY, daN/m ² WITH DEFLECTION \leq L/180 max 20mm; L/200; L/250; L/300 OF A SPAN																				
Spessore / thickness	(q) CARICO LIMITE LIMIT DESIGN DEFLECTION																			
		Distanza tra gli appoggi "L" in metri / Pitch "L" in metres between the supports																		
mm	freccia / deflection	1,50	1,75	2,00	2,25	2,50	2,75	3,00	3,25	3,50	3,75	4,00	4,25	4,50	4,75	5,00	5,25	5,50	5,75	6,00
0,60	q lim SLU	646	510	413	342	288	246	213	186	164	146	130	117	106	96	88	81	74	68	63
	q lim (L/180*)	646	510	413	342	288	246	213	186	164	146	130	104	82	66	54	44	37	31	26
	q lim (L/200)	646	510	413	342	288	246	213	186	164	146	130	110	93	79	68	58	51	44	39
	q lim (L/250)	646	510	413	342	288	246	213	186	158	128	106	88	74	63	54	47	41	36	31
	q lim (L/300)	646	510	413	342	288	246	209	164	131	107	88	73	62	53	45	39	34	30	26
0,80	q lim SLU	952	746	601	495	415	353	304	265	233	206	184	165	149	134	121	110	100	92	84
	q lim (L/180*)	952	746	601	495	415	353	304	265	233	206	176	138	110	88	72	59	49	41	35
	q lim (L/200)	952	746	601	495	415	353	304	265	233	206	176	147	124	105	90	78	68	59	52
	q lim (L/250)	952	746	601	495	415	353	304	262	210	171	141	117	99	84	72	62	54	47	42
	q lim (L/300)	952	746	601	495	415	353	278	219	175	142	117	98	82	70	60	52	45	39	35
1,00	q lim SLU	1279	996	799	655	547	464	399	346	304	269	239	211	189	169	153	139	126	115	106
	q lim (L/180*)	1279	996	799	655	547	464	399	346	304	269	220	173	137	111	90	74	62	52	43
	q lim (L/200)	1279	996	799	655	547	464	399	346	304	267	220	183	154	131	113	97	85	74	65
	q lim (L/250)	1279	996	799	655	547	464	399	328	263	214	176	147	124	105	90	78	68	59	52
	q lim (L/300)	1279	996	799	655	547	451	348	273	219	178	147	122	103	88	75	65	56	49	43
1,25	q lim SLU	1711	1325	1058	864	720	609	522	452	393	343	301	267	238	213	193	175	159	146	134
	q lim (L/180*)	1711	1325	1058	864	720	609	522	452	393	343	275	216	172	138	113	93	77	64	54
	q lim (L/200)	1711	1325	1058	864	720	609	522	452	393	334	275	229	193	164	141	122	106	93	81
	q lim (L/250)	1711	1325	1058	864	720	609	521	410	328	267	220	183	154	131	113	97	85	74	65
	q lim (L/300)	1711	1325	1058	864	720	564	435	342	274	222	183	153	129	109	94	81	71	62	54
1,50	q lim SLU	2164	1669	1328	1082	899	759	648	552	476	415	365	323	288	259	233	212	193	176	162
	q lim (L/180*)	2164	1669	1328	1082	899	759	648	552	476	415	330	259	206	166	135	111	92	77	65
	q lim (L/200)	2164	1669	1328	1082	899	759	648	552	476	401	330	275	232	197	169	146	127	111	98
	q lim (L/250)	2164	1669	1328	1082	899	759	626	492	394	320	264	220	185	158	135	117	102	89	78
	q lim (L/300)	2164	1669	1328	1082	899	677	522	410	328	267	220	183	155	131	113	97	85	74	65

LEGENDA / INDEX

Valori carico ammissibile uniformemente distribuito <i>Distributed load and resistance factor design</i>	>	Per la condizione di Stato Limite Ultimo (SLU) della lamiera / <i>Ultimate limit-state design of the corrugated sheet (SLU)</i>
	>	Per la condizione di Stato Limite di Esercizio (SLE) della lamiera ($F \leq$ L/180; L/200; L/250; L/300) / <i>Serviceability limit of the corrugated sheet (SLE) ($F \leq$ L/180; L/200; L/250; L/300)</i>
	>	Per la condizione di Stato Limite di Esercizio (SLE) della lamiera ($F \leq$ *solo max 20mm) / <i>Serviceability limit of the corrugated sheet (SLE) ($F \leq$ only max 20mm)</i>

I rapporti di prova pubblicati in questo catalogo vengono forniti a titolo puramente indicativo. I dati pubblicati sono stati calcolati secondo le Norme vigenti: NTC2018, Circolare esplicativa alle NTC2018, UNI EN 1993 (EC3). Per una corretta applicazione del prodotto sarà onere e cura del cliente e/o del progettista la redazione di calcoli appropriati con specifico riferimento al singolo impiego.

The test reports published in this catalogue are provided for indicative purposes only. The published data have been calculated according to the current regulations: NTC2018, Explanatory circular to NTC2018, UNI EN 1993 (EC3). For a correct application of the product, it will be responsibility and care of the customer and/or the designer to draw up appropriate calculations with specific reference to the individual use.

TABELLA DI PORTATA E/S 4000: ACCIAIO S 250 GD / LOAD TABLE E/S 4000: STEEL S 250 GD

I valori di portata in tabella non includono il peso proprio della lamiera grecata.
The capacity load shown in the table does not include the weight of the metal sheet itself.

TABELLA DI PORTATA E/S 4000 NORMALE: ACCIAIO S 250 GD / LOAD TABLE E/S 4000 NORMAL POSITION: STEEL S 250 GD																				
Appoggio esterno 100 mm; appoggio interno 100 mm / End support 100 mm; internal support 100 mm																				
Coefficients di sicurezza sulle portate allo SLU (γ_q): 1,40 / Safety coefficient applied to SLU (γ_q): 1,40																				
PORTATA DEL PROFILO IN daN/m ² CON FRECCIA $\leq L/180$ max 20mm; L/200; L/250; L/300 / SHEET CAPACITY, daN /m ² WITH DEFLECTION $\leq L/180$ max 20mm; L/200; L/250; L/300 OF A SPAN																				
Spessore / thickness	(q) CARICO LIMITE LIMIT DESIGN DEFLECTION	 Distanza tra gli appoggi "L" in metri / Pitch "L" in metres between the supports																		
		freccia / deflection	1,50	1,75	2,00	2,25	2,50	2,75	3,00	3,25	3,50	3,75	4,00	4,25	4,50	4,75	5,00	5,25	5,50	5,75
0,60	q lim SLU	770	610	496	412	348	298	258	226	199	177	159	143	129	118	108	99	91	84	78
	q lim (L/180*)	770	610	496	412	348	298	258	215	172	134	104	81	65	52	42	35	29	24	20
	q lim (L/200)	770	610	496	412	348	298	246	193	155	126	104	86	73	62	53	46	40	35	31
	q lim (L/250)	770	610	496	412	340	255	197	155	124	101	83	69	58	50	42	37	32	28	25
	q lim (L/300)	770	610	496	388	283	213	164	129	103	84	69	58	49	41	35	31	27	23	20
0,80	q lim SLU	1140	896	724	598	503	428	370	322	284	252	225	202	182	166	151	137	125	115	105
	q lim (L/180*)	1140	896	724	598	503	428	364	286	229	179	138	108	86	69	57	47	39	32	27
	q lim (L/200)	1140	896	724	598	503	425	328	258	206	168	138	115	97	83	71	61	53	47	41
	q lim (L/250)	1140	896	724	598	453	340	262	206	165	134	111	92	78	66	57	49	43	37	33
	q lim (L/300)	1140	896	724	518	377	283	218	172	138	112	92	77	65	55	47	41	35	31	27
1,00	q lim SLU	1537	1202	966	795	665	565	487	423	372	329	293	263	236	211	191	173	158	144	133
	q lim (L/180*)	1537	1202	966	795	665	565	455	358	286	224	173	136	108	87	71	58	48	40	34
	q lim (L/200)	1537	1202	966	795	665	532	409	322	258	210	173	144	121	103	88	76	66	58	51
	q lim (L/250)	1537	1202	966	776	566	425	328	258	206	168	138	115	97	83	71	61	53	47	41
	q lim (L/300)	1537	1202	921	647	472	354	273	215	172	140	115	96	81	69	59	51	44	39	34
1,25	q lim SLU	2064	1604	1284	1052	877	744	638	554	485	428	376	333	297	267	241	218	199	182	167
	q lim (L/180*)	2064	1604	1284	1052	877	738	569	447	358	280	216	169	135	109	88	73	60	51	43
	q lim (L/200)	2064	1604	1284	1052	877	665	512	403	322	262	216	180	152	129	111	96	83	73	64
	q lim (L/250)	2064	1604	1284	971	708	532	410	322	258	210	173	144	121	103	88	76	66	58	51
	q lim (L/300)	2064	1604	1152	809	590	443	341	268	215	175	144	120	101	86	74	64	55	48	43
1,50	q lim SLU	2618	2026	1616	1319	1098	928	795	689	595	519	456	404	360	323	292	265	241	221	203
	q lim (L/180*)	2618	2026	1616	1319	1098	886	683	537	430	336	259	203	162	130	106	87	73	61	51
	q lim (L/200)	2618	2026	1616	1319	1062	798	614	483	387	315	259	216	182	155	133	115	100	87	77
	q lim (L/250)	2618	2026	1616	1165	849	638	492	387	310	252	207	173	146	124	106	92	80	70	61
	q lim (L/300)	2618	2026	1382	971	708	532	410	322	258	210	173	144	121	103	88	76	66	58	51
LEGENDA / INDEX																				
Valori carico ammissibile uniformemente distribuito Distributed load and resistance factor design	>	Per la condizione di Stato Limite Ultimo (SLU) della lamiera / <i>Ultimate limit-state design of the corrugated sheet (SLU)</i>																		
	>	Per la condizione di Stato Limite di Esercizio (SLE) della lamiera ($F \leq L/180; L/200; L/250; L/300$) / <i>Serviceability limit of the corrugated sheet (SLE) ($F \leq L/180; L/200; L/250; L/300$)</i>																		
	>	Per la condizione di Stato Limite di Esercizio (SLE) della lamiera ($F \leq$ *solo max 20mm) / <i>Serviceability limit of the corrugated sheet (SLE) ($F \leq$ only max 20mm)</i>																		

LAMIERE DA SOLAIO
SLAB CORRUGATED SHEETS

I rapporti di prova pubblicati in questo catalogo vengono forniti a titolo puramente indicativo. I dati pubblicati sono stati calcolati secondo le Norme vigenti: NTC2018, Circolare esplicativa alle NTC2018, UNI EN 1993 (EC3). Per una corretta applicazione del prodotto sarà onere e cura del cliente e/o del progettista la redazione di calcoli appropriati con specifico riferimento al singolo impiego.

The test reports published in this catalogue are provided for indicative purposes only. The published data have been calculated according to the current regulations: NTC2018, Explanatory circular to NTC2018, UNI EN 1993 (EC3). For a correct application of the product, it will be responsibility and care of the customer and/or the designer to draw up appropriate calculations with specific reference to the individual use.

LG 55 600/750 LAMIERA DA SOLAIO - SLAB CORRUGATED SHEET



CLASSE / CLASS



Lamiera da solaio a secco, dai minimi ingombri, che coniuga leggerezza, praticità e rapidità di posa. Presenta un profilo quadro, ideale per solai caratterizzati da spazi contenuti. E' disponibile anche nella versione AM per solai collaboranti.

Dry slab metal sheet, with minimal dimensions, which combines lightness, practicality and quick installation. It has a square profile, ideal for slabs characterized by limited spaces. It is also available in the AM version for collaborative slabs.

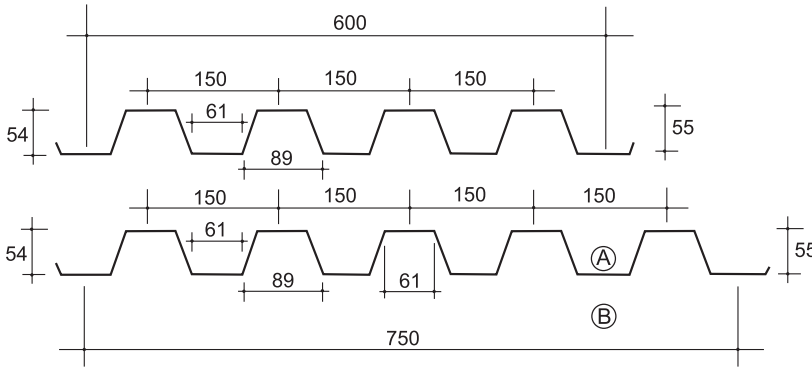

Nei disegni, A o B indicano il lato preverniciato desiderato.
In the drawings A or B show the wished prepainted side.

Nome del prodotto Product name	Numero greche Number of ribs (nr)	Interasse greche Pitch (mm)	Altezza greca Rib height (mm)	Larghezza greca Rib width (mm)	Base greca Rib long base (mm)	Larghezza modulo Covering width (mm)	Numero greche di sormonto Rib overlap (nr)
LG 55	4/5	150	55	61	61	600/750	1

Caratteristiche tecniche - Datasheet

Dimensioni: larghezza 600 / 750 (mm), lunghezza a richiesta da produzione in continuo.

Spessori: fino a mm 1,5 - anche non standard su richiesta.

Alcune tipologie di acciaio, fornibili a richiesta previo accordo sui quantitativi minimi: S 235; S 250 GD+Z; S 260 NC; S 275; S 280 GD+Z; S 315 MC; S 315 NC; S 320 GD+Z (ed altri ancora).

Supporti: acciaio zincato preverniciato o plastificato;
Trattamenti protettivi applicabili a richiesta: Preverniciatura con poliestere, superpoliestere (hd) Disponibilità su richiesta di altri film e rivestimenti.

Dimensions: width 600 / 750 (mm), length upon request from continuous production process.

Thicknesses (S): up to mm 1,5 - also non-standard on request.

Some types of steel supplied upon request previous agreement on minimum quantities: S 235; S 250 GD+Z; S 260 NC; S 275; S 280 GD+Z; S 315 MC; S 315 NC; S 320 GD+Z (and others more).

Supports: prepainted or plasticized galvanized steel;
Protective treatments for external support available on request: Pre-painting with polyester, superpolyester (hd). Availability on request of other films and coatings.

LG 55 - ACCIAIO S 250 GD+Z / STEEL S 250 GD+Z CARATTERISTICHE STATICHE / STATIC CHARACTERISTICS													
spessore lamiera - sheet metal thickness	Peso weight (passo) 750 mm	PROPRIETA' DI MASSA LORDE: GROSS MASS PROPERTY:				PROPRIETA' DI MASSA EFFICACI: - EFFECTIVE MASS PROPERTIES:							
						MOMENTO POSITIVO IN CAMPATA POSITIVE MOMENT ON SPAN				MOMENTO NEGATIVO SULL'APPOGGIO NEGATIVE MOMENT ON SUPPORT			
		A	J _{xG}	W _{e sup}	W _{e inf}	A _{eff}	J _{xG eff}	W _{e sup eff}	W _{e inf eff}	A _{eff}	J _{xG eff}	W _{e sup eff}	W _{e inf eff}
		[kg/m ²]	cm ² /m	cm ⁴ /m	cm ³ /m	cm ² /m	cm ⁴ /m	cm ³ /m	cm ³ /m	cm ² /m	cm ⁴ /m	cm ³ /m	cm ³ /m
0,6	7,3	9,420	48,355	17,584	17,584	8,144	37,195	11,694	16,038	8,144	37,195	16,038	11,694
0,8	9,8	12,560	64,479	23,447	23,447	11,283	53,727	17,551	22,031	11,283	53,727	22,031	17,551
1,0	12,2	15,701	80,607	29,311	29,311	14,576	71,445	24,119	28,152	14,576	71,445	28,152	24,119
1,25	15,3	19,626	100,774	36,645	36,645	18,855	94,703	33,085	35,906	18,855	94,703	35,906	33,085
1,5	18,4	23,551	120,952	43,983	43,983	23,250	118,650	42,595	43,710	23,250	118,650	43,710	42,595

TABELLA DI PORTATA LG 55: ACCIAIO S 250 GD / LOAD TABLE LG 55: STEEL S 250 GD

I valori di portata in tabella non includono il peso proprio della lamiera grecata.
The capacity load shown in the table does not include the weight of the metal sheet itself.

TABELLA DI PORTATA LG 55 NORMALE: ACCIAIO S 250 GD / LOAD TABLE LG 55 NORMAL POSITION: STEEL S 250 GD																				
Appoggio esterno 100 mm; appoggio interno (non presente) / End support 100 mm; internal support (not present)																				
Coefficienti di sicurezza sulle portate allo SLU (γ_a): 1,40 / Safety coefficient applied to SLU (γ_a): 1,40																				
PORTATA DEL PROFILO IN daN/m ² CON FRECCIA \leq L/180 max 20mm; L/200; L/250; L/300 / SHEET CAPACITY, daN / m ² WITH DEFLECTION \leq L/180 max 20mm; L/200; L/250; L/300 OF A SPAN																				
Spessore / thickness	(q) CARICO LIMITE LIMIT DESIGN DEFLECTION	 Distanza tra gli appoggi "L" in metri / Pitch "L" in metres between the supports																		
		1,50	1,75	2,00	2,25	2,50	2,75	3,00	3,25	3,50	3,75	4,00	4,25	4,50	4,75	5,00	5,25	5,50	5,75	6,00
mm	freccia / deflection	1,50	1,75	2,00	2,25	2,50	2,75	3,00	3,25	3,50	3,75	4,00	4,25	4,50	4,75	5,00	5,25	5,50	5,75	6,00
0,60	q lim SLU	668	572	501	445	399	330	277	236	204	177	156	138	123	111	100	90	82	75	69
	q lim (L/180*)	668	572	501	388	283	212	164	129	103	80	62	49	39	31	25	21	17	15	-
	q lim (L/200)	668	572	497	349	254	191	147	116	93	75	62	52	44	37	32	27	24	21	-
	q lim (L/250)	668	572	397	279	204	153	118	93	74	60	50	41	35	30	25	22	19	17	-
	q lim (L/300)	668	494	331	233	170	127	98	77	62	50	41	35	29	25	21	18	16	14	-
0,80	q lim SLU	1139	976	838	662	536	443	372	317	274	238	209	186	165	149	134	122	111	101	93
	q lim (L/180*)	1139	976	736	517	377	283	218	172	137	107	83	65	52	42	34	28	23	19	-
	q lim (L/200)	1139	976	663	465	339	255	196	154	124	101	83	69	58	49	42	37	32	28	-
	q lim (L/250)	1139	791	530	372	271	204	157	124	99	80	66	55	47	40	34	29	25	22	-
	q lim (L/300)	1047	659	442	310	226	170	131	103	82	67	55	46	39	33	28	24	21	19	-
1,00	q lim SLU	1725	1378	1055	834	675	558	469	400	344	300	264	234	208	187	169	153	139	128	117
	q lim (L/180*)	1725	1374	920	646	471	354	273	214	172	134	104	81	65	52	42	35	29	24	-
	q lim (L/200)	1725	1236	828	582	424	319	245	193	155	126	104	86	73	62	53	46	40	35	-
	q lim (L/250)	1571	989	663	465	339	255	196	154	124	101	83	69	58	49	42	37	32	28	-
	q lim (L/300)	1309	824	552	388	283	212	164	129	103	84	69	58	48	41	35	31	27	23	-
1,25	q lim SLU	2366	1738	1331	1052	852	704	592	504	435	379	333	295	263	236	213	193	176	161	148
	q lim (L/180*)	2366	1717	1151	808	589	443	341	268	215	168	129	102	81	65	53	44	36	30	-
	q lim (L/200)	2366	1546	1035	727	530	398	307	241	193	157	129	108	91	77	66	57	50	44	-
	q lim (L/250)	1964	1237	828	582	424	319	245	193	155	126	104	86	73	62	53	46	40	35	-
	q lim (L/300)	1636	1030	690	485	353	266	205	161	129	105	86	72	61	52	44	38	33	29	-
1,50	q lim SLU	2866	2105	1612	1274	1032	853	716	610	526	459	403	357	318	286	258	234	213	195	179
	q lim (L/180*)	2866	2061	1381	970	707	531	409	322	258	201	155	122	97	78	64	52	43	36	-
	q lim (L/200)	2866	1855	1243	873	636	478	368	290	232	189	155	130	109	93	80	69	60	52	-
	q lim (L/250)	2357	1484	994	698	509	382	295	232	186	151	124	104	87	74	64	55	48	42	-
	q lim (L/300)	1964	1237	829	582	424	319	245	193	155	126	104	86	73	62	53	46	40	35	-
LEGENDA / INDEX																				
Valori carico ammissibile uniformemente distribuito <i>Distributed load and resistance factor design</i>	>	Per la condizione di Stato Limite Ultimo (SLU) della lamiera / <i>Ultimate limit-state design of the corrugated sheet (SLU)</i>																		
	>	Per la condizione di Stato Limite di Esercizio (SLE) della lamiera ($F \leq$ L/180; L/200; L/250; L/300) / <i>Serviceability limit of the corrugated sheet (SLE) ($F \leq$ L/180; L/200; L/250; L/300)</i>																		
	>	Per la condizione di Stato Limite di Esercizio (SLE) della lamiera ($F \leq$ *solo max 20mm) / <i>Serviceability limit of the corrugated sheet (SLE) ($F \leq$ only max 20mm)</i>																		

LAMIERE DA SOLAIO
SLAB CORRUGATED SHEETS

I rapporti di prova pubblicati in questo catalogo vengono forniti a titolo puramente indicativo. I dati pubblicati sono stati calcolati secondo le Norme vigenti: NTC2018, Circolare esplicativa alle NTC2018, UNI EN 1993 (EC3). Per una corretta applicazione del prodotto sarà onere e cura del cliente e/o del progettista la redazione di calcoli appropriati con specifico riferimento al singolo impiego.

The test reports published in this catalogue are provided for indicative purposes only. The published data have been calculated according to the current regulations: NTC2018, Explanatory circular to NTC2018, UNI EN 1993 (EC3). For a correct application of the product, it will be responsibility and care of the customer and/or the designer to draw up appropriate calculations with specific reference to the individual use.

TABELLA DI PORTATA LG 55: ACCIAIO S 250 GD / LOAD TABLE LG 55: STEEL S 250 GD

I valori di portata in tabella non includono il peso proprio della lamiera grecata.
The capacity load shown in the table does not include the weight of the metal sheet itself.

TABELLA DI PORTATA LG 55 NORMALE: ACCIAIO S 250 GD / LOAD TABLE LG 55 NORMAL POSITION: STEEL S 250 GD																				
Appoggio esterno 100 mm; appoggio interno 100 mm / End support 100 mm; internal support 100 mm																				
Coefficients di sicurezza sulle portate allo SLU (γ_q): 1,40 / Safety coefficient applied to SLU (γ_q): 1,40																				
PORTATA DEL PROFILO IN daN/m ² CON FRECCIA $\leq L/180$ max 20mm; L/200; L/250; L/300 / SHEET CAPACITY, daN/m ² WITH DEFLECTION $\leq L/180$ max 20mm; L/200; L/250; L/300 OF A SPAN																				
Spessore / thickness	(q) CARICO LIMITE LIMIT DESIGN DEFLECTION	 Distanza tra gli appoggi "L" in metri / Pitch "L" in metres between the supports																		
		mm	freccia / deflection	1,50	1,75	2,00	2,25	2,50	2,75	3,00	3,25	3,50	3,75	4,00	4,25	4,50	4,75	5,00	5,25	5,50
0,60	q lim SLU	706	558	453	375	316	270	234	204	180	160	143	129	117	106	97	89	82	75	69
	q lim (L/180*)	706	558	453	375	316	270	234	204	180	160	143	119	95	76	62	51	42	35	30
	q lim (L/200)	706	558	453	375	316	270	234	204	180	160	143	126	106	90	78	67	58	51	45
	q lim (L/250)	706	558	453	375	316	270	234	204	180	147	121	101	85	72	62	54	47	41	36
	q lim (L/300)	706	558	453	375	316	270	234	188	151	123	101	84	71	60	52	45	39	34	30
0,80	q lim SLU	1043	817	659	543	455	388	334	291	256	227	202	182	164	149	134	122	111	101	93
	q lim (L/180*)	1043	817	659	543	455	388	334	291	256	227	202	158	126	102	83	68	56	47	40
	q lim (L/200)	1043	817	659	543	455	388	334	291	256	227	202	168	142	121	103	89	78	68	60
	q lim (L/250)	1043	817	659	543	455	388	334	291	241	196	162	135	113	96	83	71	62	54	48
	q lim (L/300)	1043	817	659	543	455	388	319	251	201	163	135	112	95	80	69	60	52	45	40
1,00	q lim SLU	1402	1093	877	719	601	510	439	381	334	296	263	234	208	187	169	153	139	128	117
	q lim (L/180*)	1402	1093	877	719	601	510	439	381	334	296	252	198	158	127	103	85	71	59	50
	q lim (L/200)	1402	1093	877	719	601	510	439	381	334	296	252	210	177	151	129	112	97	85	75
	q lim (L/250)	1402	1093	877	719	601	510	439	376	301	245	202	168	142	121	103	89	78	68	60
	q lim (L/300)	1402	1093	877	719	601	510	399	314	251	204	168	140	118	100	86	74	65	57	50
1,25	q lim SLU	1877	1455	1162	950	791	670	574	498	435	379	333	295	263	236	213	193	176	161	148
	q lim (L/180*)	1877	1455	1162	950	791	670	574	498	435	379	316	248	197	159	129	106	88	74	62
	q lim (L/200)	1877	1455	1162	950	791	670	574	498	435	379	316	263	222	188	162	140	121	106	94
	q lim (L/250)	1877	1455	1162	950	791	670	574	471	377	306	252	210	177	151	129	112	97	85	75
	q lim (L/300)	1877	1455	1162	950	791	647	499	392	314	255	210	175	148	126	108	93	81	71	62
1,50	q lim SLU	2375	1833	1459	1189	988	834	714	610	526	459	403	357	318	286	258	234	213	195	179
	q lim (L/180*)	2375	1833	1459	1189	988	834	714	610	526	459	379	297	236	190	155	128	106	89	75
	q lim (L/200)	2375	1833	1459	1189	988	834	714	610	526	459	379	316	266	226	194	168	146	128	112
	q lim (L/250)	2375	1833	1459	1189	988	834	714	565	452	368	303	253	213	181	155	134	117	102	90
	q lim (L/300)	2375	1833	1459	1189	988	777	599	471	377	306	253	211	177	151	129	112	97	85	75

LEGENDA / INDEX

Valori carico ammissibile uniformemente distribuito Distributed load and resistance factor design	>	Per la condizione di Stato Limite Ultimo (SLU) della lamiera / <i>Ultimate limit-state design of the corrugated sheet (SLU)</i>
	>	Per la condizione di Stato Limite di Esercizio (SLE) della lamiera ($F \leq L/180; L/200; L/250; L/300$) / <i>Serviceability limit of the corrugated sheet (SLE) ($F \leq L/180; L/200; L/250; L/300$)</i>
	>	Per la condizione di Stato Limite di Esercizio (SLE) della lamiera ($F \leq$ *solo max 20mm) / <i>Serviceability limit of the corrugated sheet (SLE) ($F \leq$ only max 20mm)</i>

I rapporti di prova pubblicati in questo catalogo vengono forniti a titolo puramente indicativo. I dati pubblicati sono stati calcolati secondo le Norme vigenti: NTC2018, Circolare esplicativa alle NTC2018, UNI EN 1993 (EC3). Per una corretta applicazione del prodotto sarà onere e cura del cliente e/o del progettista la redazione di calcoli appropriati con specifico riferimento al singolo impiego.

The test reports published in this catalogue are provided for indicative purposes only. The published data have been calculated according to the current regulations: NTC2018, Explanatory circular to NTC2018, UNI EN 1993 (EC3). For a correct application of the product, it will be responsibility and care of the customer and/or the designer to draw up appropriate calculations with specific reference to the individual use.

TABELLA DI PORTATA LG 55: ACCIAIO S 250 GD / LOAD TABLE LG 55: STEEL S 250 GD

I valori di portata in tabella non includono il peso proprio della lamiera grecata.
The capacity load shown in the table does not include the weight of the metal sheet itself.

TABELLA DI PORTATA LG 55 NORMALE: ACCIAIO S 250 GD / LOAD TABLE LG 55 NORMAL POSITION: STEEL S 250 GD																				
Appoggio esterno 100 mm; appoggio interno 100 mm / End support 100 mm; internal support 100 mm																				
Coefficients di sicurezza sulle portate allo SLU (γ_q): 1,40 / Safety coefficient applied to SLU (γ_q): 1,40																				
PORTATA DEL PROFILO IN daN/m ² CON FRECCIA $\leq L/180$ max 20mm; L/200; L/250; L/300 / SHEET CAPACITY, daN /m ² WITH DEFLECTION $\leq L/180$ max 20mm; L/200; L/250; L/300 OF A SPAN																				
Spessore / thickness	(q) CARICO LIMITE LIMIT DESIGN DEFLECTION	 Distanza tra gli appoggi "L" in metri / Pitch "L" in metres between the supports																		
		1,50	1,75	2,00	2,25	2,50	2,75	3,00	3,25	3,50	3,75	4,00	4,25	4,50	4,75	5,00	5,25	5,50	5,75	6,00
0,60	freccia / deflection																			
	q lim SLU	834	667	543	451	381	327	283	248	219	195	174	157	142	129	118	109	100	92	86
	q lim (L/180*)	834	667	543	451	381	327	283	246	197	154	119	93	74	60	49	40	33	28	23
	q lim (L/200)	834	667	543	451	381	327	282	222	178	144	119	99	84	71	61	53	46	40	35
	q lim (L/250)	834	667	543	451	381	293	226	177	142	115	95	79	67	57	49	42	37	32	28
q lim (L/300)	834	667	543	445	325	244	188	148	118	96	79	66	56	47	41	35	30	27	23	
0,80	q lim SLU	1248	982	794	656	552	471	406	354	312	277	247	222	201	182	166	152	138	127	116
	q lim (L/180*)	1248	982	794	656	552	471	406	328	263	205	159	124	99	80	65	53	44	37	31
	q lim (L/200)	1248	982	794	656	552	471	376	296	237	192	159	132	111	95	81	70	61	53	47
	q lim (L/250)	1248	982	794	656	520	390	301	237	189	154	127	106	89	76	65	56	49	43	38
	q lim (L/300)	1248	982	794	594	433	325	251	197	158	128	106	88	74	63	54	47	41	36	31
1,00	q lim SLU	1684	1318	1060	872	731	621	535	465	409	362	323	289	260	234	211	191	174	160	147
	q lim (L/180*)	1684	1318	1060	872	731	621	522	411	329	257	198	156	124	100	81	67	55	46	39
	q lim (L/200)	1684	1318	1060	872	731	610	470	370	296	241	198	165	139	118	102	88	76	67	59
	q lim (L/250)	1684	1318	1060	872	650	488	376	296	237	192	159	132	111	95	81	70	61	53	47
	q lim (L/300)	1684	1318	1057	743	541	407	313	246	197	160	132	110	93	79	68	58	51	44	39
1,25	q lim SLU	2263	1760	1410	1155	964	817	702	609	534	472	416	368	329	295	266	241	220	201	185
	q lim (L/180*)	2263	1760	1410	1155	964	817	653	513	411	321	248	194	155	125	102	84	69	58	49
	q lim (L/200)	2263	1760	1410	1155	964	763	587	462	370	301	248	207	174	148	127	110	95	83	73
	q lim (L/250)	2263	1760	1410	1114	812	610	470	370	296	241	198	165	139	118	102	88	76	67	59
	q lim (L/300)	2263	1760	1322	928	677	508	392	308	247	201	165	138	116	99	85	73	64	56	49
1,50	q lim SLU	2872	2224	1775	1450	1207	1021	875	758	658	573	504	446	398	357	322	292	266	244	224
	q lim (L/180*)	2872	2224	1775	1450	1207	1017	783	616	493	385	297	233	186	150	122	100	83	70	59
	q lim (L/200)	2872	2224	1775	1450	1207	915	705	555	444	361	297	248	209	178	152	132	114	100	88
	q lim (L/250)	2872	2224	1775	1337	975	732	564	444	355	289	238	198	167	142	122	105	92	80	71
	q lim (L/300)	2872	2224	1587	1114	812	610	470	370	296	241	198	165	139	118	102	88	76	67	59

LEGENDA / INDEX

Valori carico ammissibile uniformemente distribuito
Distributed load and resistance factor design

>
>
>

Per la condizione di Stato Limite Ultimo (SLU) della lamiera / *Ultimate limit-state design of the corrugated sheet (SLU)*
Per la condizione di Stato Limite di Esercizio (SLE) della lamiera ($F \leq L/180; L/200; L/250; L/300$) / *Serviceability limit of the corrugated sheet (SLE) ($F \leq L/180; L/200; L/250; L/300$)*
Per la condizione di Stato Limite di Esercizio (SLE) della lamiera ($F \leq$ *solo max 20mm) / *Serviceability limit of the corrugated sheet (SLE) ($F \leq$ only max 20mm)*

I rapporti di prova pubblicati in questo catalogo vengono forniti a titolo puramente indicativo. I dati pubblicati sono stati calcolati secondo le Norme vigenti: NTC2018, Circolare esplicativa alle NTC2018, UNI EN 1993 (EC3). Per una corretta applicazione del prodotto sarà onere e cura del cliente e/o del progettista la redazione di calcoli appropriati con specifico riferimento al singolo impiego.

The test reports published in this catalogue are provided for indicative purposes only. The published data have been calculated according to the current regulations: NTC2018, Explanatory circular to NTC2018, UNI EN 1993 (EC3). For a correct application of the product, it will be responsibility and care of the customer and/or the designer to draw up appropriate calculations with specific reference to the individual use.

LG 75 LAMIERA DA SOLAIO - SLAB CORRUGATED SHEET



CLASSE / CLASS



PRODOTTI CERTIFICATI EPD
Criteri Ambientali Minimi (CAM)

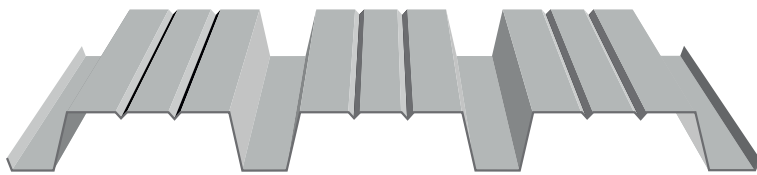

Lamiera grecata per coperture su medie luci, che consente di razionalizzare e ridurre il numero degli elementi che compongono la struttura della copertura. E' disponibile anche nella versione AM per solai collaboranti.

Corrugated metal sheet for roofs of medium spans which makes possible to rationalize and reduce the number of elements that make up the roof structure. It is also available in the AM version for collaborating floors.

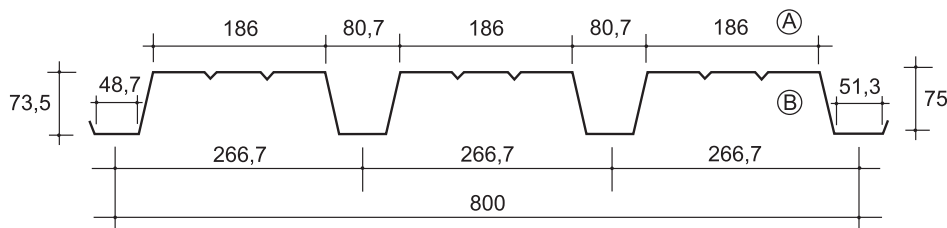

Nei disegni, A o B indicano il lato preverniciato desiderato.
In the drawings A or B show the wished pre-painted side.

Nome del prodotto Product name	Numero greche Number of ribs (nr)	Interasse greche Pitch (mm)	Altezza greca Rib height (mm)	Larghezza greca Rib width (mm)	Base greca Rib long base (mm)	Larghezza modulo Covering width (mm)	Numero greche di sormonto Rib overlap (nr)
LG 75	2	266,7	75	51,3	186	800	1

Caratteristiche tecniche - Datasheet

Dimensioni: larghezza 800 (mm), lunghezza a richiesta da produzione in continuo.

Spessori: fino a mm 1,5 - anche non standard su richiesta.

Alcune tipologie di acciaio, fornibili a richiesta previo accordo sui quantitativi minimi: S 235; S 250 GD+Z; S 260 NC; S 275; S 280 GD+Z; S 315 MC; S 315 NC; S 320 GD+Z (ed altri ancora).

Supporti: acciaio zincato preverniciato o plastificato;
Trattamenti protettivi applicabili a richiesta: Preverniciatura con poliestere, superpoliestere (hd) Disponibilità su richiesta di altri film e rivestimenti.

Dimensions: width 800 (mm), length upon request from continuous production process.

Thicknesses (S): up to mm 1,5 - also non-standard on request.

Some types of steel supplied upon request previous agreement on minimum quantities: S 235; S 250 GD+Z; S 260 NC; S 275; S 280 GD+Z; S 315 MC; S 315 NC; S 320 GD+Z (and others more).

Supports: pre-painted or plasticized galvanized steel;
Protective treatments for external support available on request: Pre-painting with polyester, superpolyester (hd). Availability on request of other films and coatings.

LG 75 - ACCIAIO S 250 GD+Z / STEEL S 250 GD+Z CARATTERISTICHE STATICHE / STATIC CHARACTERISTICS													
spessore lamiera - sheet metal thickness	Peso weight (passo) 800 mm	PROPRIETA' DI MASSA LORDE: GROSS MASS PROPERTY:				PROPRIETA' DI MASSA EFFICACI: - EFFECTIVE MASS PROPERTIES:							
						MOMENTO POSITIVO IN CAMPATA POSITIVE MOMENT ON SPAN				MOMENTO NEGATIVO SULL'APPOGGIO NEGATIVE MOMENT ON SUPPORT			
		A	J _{xG}	W _{e sup}	W _{e inf}	A _{eff}	J _{xG eff}	W _{e sup eff}	W _{e inf eff}	A _{eff}	J _{xG eff}	W _{e sup eff}	W _{e inf eff}
		cm ² /m	cm ⁴ /m	cm ³ /m	cm ³ /m	cm ² /m	cm ⁴ /m	cm ³ /m	cm ³ /m	cm ² /m	cm ⁴ /m	cm ³ /m	cm ³ /m
0,6	8,0	8,957	77,138	31,928	15,173	6,056	52,421	14,702	13,324	7,460	53,455	30,942	9,260
0,8	10,4	11,943	102,856	42,572	20,231	8,634	76,536	22,952	18,375	10,955	85,245	41,282	15,684
1,0	13,0	14,929	128,577	53,218	25,291	11,455	102,592	32,650	23,542	14,583	119,413	52,025	22,943
1,25	16,3	18,661	160,736	66,529	31,616	15,078	135,329	45,343	29,970	18,531	157,339	66,102	30,732
1,5	19,3	22,393	192,904	79,843	37,944	18,061	162,075	54,199	35,940	22,393	192,904	79,843	37,944

TABELLA DI PORTATA LG 75: ACCIAIO S 250 GD / LOAD TABLE LG 75: STEEL S 250 GD

I valori di portata in tabella non includono il peso proprio della lamiera grecata.
The capacity load shown in the table does not include the weight of the metal sheet itself.

TABELLA DI PORTATA LG 75 NORMALE: ACCIAIO S 250 GD / LOAD TABLE LG 75 NORMAL POSITION: STEEL S 250 GD																				
Appoggio esterno 100 mm; appoggio interno (non presente) / End support 100 mm; internal support (not present)																				
Coefficienti di sicurezza sulle portate allo SLU (γ_a): 1,40 / Safety coefficient applied to SLU (γ_a): 1,40																				
PORTATA DEL PROFILO IN daN/m ² CON FRECCIA \leq L/180 max 20mm; L/200; L/250; L/300 / SHEET CAPACITY, daN /m ² WITH DEFLECTION \leq L/180 max 20mm; L/200; L/250; L/300 OF A SPAN																				
Spessore / thickness	(q) CARICO LIMITE LIMIT DESIGN DEFLECTION	 Distanza tra gli appoggi "L" in metri / Pitch "L" in metres between the supports																		
		1,50	1,75	2,00	2,25	2,50	2,75	3,00	3,25	3,50	3,75	4,00	4,25	4,50	4,75	5,00	5,25	5,50	5,75	6,00
mm	freccia / deflection	1,50	1,75	2,00	2,25	2,50	2,75	3,00	3,25	3,50	3,75	4,00	4,25	4,50	4,75	5,00	5,25	5,50	5,75	6,00
0,60	q lim SLU	379	324	284	252	227	206	189	175	151	131	115	102	91	82	74	67	61	56	51
	q lim (L/180*)	379	324	284	252	227	206	177	139	112	87	67	53	42	34	28	23	19	16	-
	q lim (L/200)	379	324	284	252	227	206	160	126	101	82	67	56	47	40	34	30	26	23	-
	q lim (L/250)	379	324	284	252	221	166	128	100	80	65	54	45	38	32	28	24	21	18	-
	q lim (L/300)	379	324	284	252	184	138	106	84	67	54	45	37	32	27	23	20	17	15	-
0,80	q lim SLU	643	551	482	429	386	337	283	241	208	181	159	141	126	113	102	92	84	77	71
	q lim (L/180*)	643	551	482	429	386	336	259	204	163	127	98	77	61	49	40	33	28	23	-
	q lim (L/200)	643	551	482	429	386	303	233	183	147	119	98	82	69	59	50	43	38	33	-
	q lim (L/250)	643	551	482	429	322	242	186	147	117	95	79	66	55	47	40	35	30	26	-
	q lim (L/300)	643	551	482	368	268	202	155	122	98	80	66	55	46	39	34	29	25	22	-
1,00	q lim SLU	971	832	728	645	522	432	363	309	267	232	204	181	161	145	131	118	108	99	91
	q lim (L/180*)	971	832	728	645	522	432	347	273	219	171	132	103	82	66	54	44	37	31	-
	q lim (L/200)	971	832	728	645	522	406	312	246	197	160	132	110	93	79	67	58	51	44	-
	q lim (L/250)	971	832	728	592	432	324	250	197	157	128	105	88	74	63	54	47	41	35	-
	q lim (L/300)	971	832	703	494	360	270	208	164	131	107	88	73	62	52	45	39	34	30	-
1,25	q lim SLU	1467	1257	1039	821	665	550	462	394	339	296	260	230	205	184	166	151	137	126	115
	q lim (L/180*)	1467	1257	1039	821	665	550	458	360	288	225	174	136	109	87	71	59	49	41	-
	q lim (L/200)	1467	1257	1039	821	665	535	412	324	259	211	174	145	122	104	89	77	67	59	-
	q lim (L/250)	1467	1257	1039	781	570	428	330	259	208	169	139	116	98	83	71	62	53	47	-
	q lim (L/300)	1467	1257	927	651	475	357	275	216	173	141	116	97	81	69	59	51	45	39	-
1,50	q lim SLU	2056	1628	1246	985	798	659	554	472	407	354	312	276	246	221	199	181	165	151	138
	q lim (L/180*)	2056	1628	1246	985	798	659	548	431	345	269	208	163	130	105	85	70	58	49	-
	q lim (L/200)	2056	1628	1246	985	798	641	493	388	311	253	208	174	146	124	107	92	80	70	-
	q lim (L/250)	2056	1628	1246	936	682	512	395	310	249	202	167	139	117	99	85	74	64	56	-
	q lim (L/300)	2056	1628	1110	780	568	427	329	259	207	168	139	116	97	83	71	61	53	47	-
LEGENDA / INDEX																				
Valori carico ammissibile uniformemente distribuito <i>Distributed load and resistance factor design</i>	>	Per la condizione di Stato Limite Ultimo (SLU) della lamiera / <i>Ultimate limit-state design of the corrugated sheet (SLU)</i>																		
	>	Per la condizione di Stato Limite di Esercizio (SLE) della lamiera ($F \leq L/180; L/200; L/250; L/300$) / <i>Serviceability limit of the corrugated sheet (SLE) ($F \leq L/180; L/200; L/250; L/300$)</i>																		
	>	Per la condizione di Stato Limite di Esercizio (SLE) della lamiera ($F \leq$ *solo max 20mm) / <i>Serviceability limit of the corrugated sheet (SLE) ($F \leq$ only max 20mm)</i>																		

LAMIERE DA SOLAIO
SLAB CORRUGATED SHEETS

I rapporti di prova pubblicati in questo catalogo vengono forniti a titolo puramente indicativo. I dati pubblicati sono stati calcolati secondo le Norme vigenti: NTC2018, Circolare esplicativa alle NTC2018, UNI EN 1993 (EC3). Per una corretta applicazione del prodotto sarà onere e cura del cliente e/o del progettista la redazione di calcoli appropriati con specifico riferimento al singolo impiego.

The test reports published in this catalogue are provided for indicative purposes only. The published data have been calculated according to the current regulations: NTC2018, Explanatory circular to NTC2018, UNI EN 1993 (EC3). For a correct application of the product, it will be responsibility and care of the customer and/or the designer to draw up appropriate calculations with specific reference to the individual use.

TABELLA DI PORTATA LG 75: ACCIAIO S 250 GD / LOAD TABLE LG 75: STEEL S 250 GD

I valori di portata in tabella non includono il peso proprio della lamiera grecata.
The capacity load shown in the table does not include the weight of the metal sheet itself.

TABELLA DI PORTATA LG 75 NORMALE: ACCIAIO S 250 GD / LOAD TABLE LG 75 NORMAL POSITION: STEEL S 250 GD																				
Appoggio esterno 100 mm; appoggio interno 100 mm / End support 100 mm; internal support 100 mm																				
Coefficients di sicurezza sulle portate allo SLU (γ_q): 1,40 / Safety coefficient applied to SLU (γ_q): 1,40																				
PORTATA DEL PROFILO IN daN/m ² CON FRECCIA \leq L/180 max 20mm; L/200; L/250; L/300 / SHEET CAPACITY, daN / m ² WITH DEFLECTION \leq L/180 max 20mm; L/200; L/250; L/300 OF A SPAN																				
Spessore / thickness	(q) CARICO LIMITE LIMIT DESIGN DEFLECTION																			
		Distanza tra gli appoggi "L" in metri / Pitch "L" in metres between the supports																		
mm	freccia / deflection	1,50	1,75	2,00	2,25	2,50	2,75	3,00	3,25	3,50	3,75	4,00	4,25	4,50	4,75	5,00	5,25	5,50	5,75	6,00
0,60	q lim SLU	381	300	243	200	169	144	124	108	95	85	76	68	61	56	51	47	42	39	36
	q lim (L/180*)	381	300	243	200	169	144	124	108	95	85	76	68	61	56	51	47	42	38	32
	q lim (L/200)	381	300	243	200	169	144	124	108	95	85	76	68	61	56	51	47	42	39	36
	q lim (L/250)	381	300	243	200	169	144	124	108	95	85	76	68	61	56	51	47	42	39	36
	q lim (L/300)	381	300	243	200	169	144	124	108	95	85	76	68	61	56	51	47	42	37	32
0,80	q lim SLU	635	501	405	335	282	241	208	182	160	142	127	114	103	94	86	78	72	66	60
	q lim (L/180*)	635	501	405	335	282	241	208	182	160	142	127	114	103	94	86	78	67	56	47
	q lim (L/200)	635	501	405	335	282	241	208	182	160	142	127	114	103	94	86	78	72	66	60
	q lim (L/250)	635	501	405	335	282	241	208	182	160	142	127	114	103	94	86	78	72	65	57
	q lim (L/300)	635	501	405	335	282	241	208	182	160	142	127	114	103	94	82	71	61	54	47
1,00	q lim SLU	930	733	593	491	413	353	305	266	234	208	186	167	151	137	125	115	105	96	88
	q lim (L/180*)	930	733	593	491	413	353	305	266	234	208	186	167	151	137	125	108	90	75	63
	q lim (L/200)	930	733	593	491	413	353	305	266	234	208	186	167	151	137	125	115	105	96	88
	q lim (L/250)	930	733	593	491	413	353	305	266	234	208	186	167	151	137	125	114	99	87	76
	q lim (L/300)	930	733	593	491	413	353	305	266	234	208	186	167	150	128	110	95	82	72	63
1,25	q lim SLU	1299	1020	823	679	571	486	419	366	321	285	254	229	206	187	170	155	141	129	118
	q lim (L/180*)	1299	1020	823	679	571	486	419	366	321	285	254	229	206	187	170	143	119	99	84
	q lim (L/200)	1299	1020	823	679	571	486	419	366	321	285	254	229	206	187	170	155	141	129	118
	q lim (L/250)	1299	1020	823	679	571	486	419	366	321	285	254	229	206	187	170	150	130	114	100
	q lim (L/300)	1299	1020	823	679	571	486	419	366	321	285	254	229	198	169	145	125	109	95	84
1,50	q lim SLU	1677	1312	1056	869	728	619	533	464	407	361	321	288	260	233	210	191	174	159	146
	q lim (L/180*)	1677	1312	1056	869	728	619	533	464	407	361	321	288	260	233	208	171	142	119	100
	q lim (L/200)	1677	1312	1056	869	728	619	533	464	407	361	321	288	260	233	210	191	174	159	146
	q lim (L/250)	1677	1312	1056	869	728	619	533	464	407	361	321	288	260	233	208	180	156	137	120
	q lim (L/300)	1677	1312	1056	869	728	619	533	464	407	361	321	282	238	202	173	150	130	114	100
LEGENDA / INDEX																				
Valori carico ammissibile uniformemente distribuito <i>Distributed load and resistance factor design</i>	>	Per la condizione di Stato Limite Ultimo (SLU) della lamiera / <i>Ultimate limit-state design of the corrugated sheet (SLU)</i>																		
	>	Per la condizione di Stato Limite di Esercizio (SLE) della lamiera ($F \leq$ L/180; L/200; L/250; L/300) / <i>Serviceability limit of the corrugated sheet (SLE) ($F \leq$ L/180; L/200; L/250; L/300)</i>																		
	>	Per la condizione di Stato Limite di Esercizio (SLE) della lamiera ($F \leq$ *solo max 20mm) / <i>Serviceability limit of the corrugated sheet (SLE) ($F \leq$ only max 20mm)</i>																		

I rapporti di prova pubblicati in questo catalogo vengono forniti a titolo puramente indicativo. I dati pubblicati sono stati calcolati secondo le Norme vigenti: NTC2018, Circolare esplicativa alle NTC2018, UNI EN 1993 (EC3). Per una corretta applicazione del prodotto sarà onere e cura del cliente e/o del progettista la redazione di calcoli appropriati con specifico riferimento al singolo impiego.

The test reports published in this catalogue are provided for indicative purposes only. The published data have been calculated according to the current regulations: NTC2018, Explanatory circular to NTC2018, UNI EN 1993 (EC3). For a correct application of the product, it will be responsibility and care of the customer and/or the designer to draw up appropriate calculations with specific reference to the individual use.

TABELLA DI PORTATA LG 75: ACCIAIO S 250 GD / LOAD TABLE LG 75: STEEL S 250 GD

I valori di portata in tabella non includono il peso proprio della lamiera grecata.
The capacity load shown in the table does not include the weight of the metal sheet itself.

TABELLA DI PORTATA LG 75 NORMALE: ACCIAIO S 250 GD / LOAD TABLE LG 75 NORMAL POSITION: STEEL S 250 GD																				
Appoggio esterno 100 mm; appoggio interno 100 mm / End support 100 mm; internal support 100 mm																				
Coefficients di sicurezza sulle portate allo SLU (γ_q): 1,40 / Safety coefficient applied to SLU (γ_q): 1,40																				
PORTATA DEL PROFILO IN daN/m ² CON FRECCIA $\leq L/180$ max 20mm; L/200; L/250; L/300 / SHEET CAPACITY, daN /m ² WITH DEFLECTION $\leq L/180$ max 20mm; L/200; L/250; L/300 OF A SPAN																				
Spessore / thickness	(q) CARICO LIMITE LIMIT DESIGN DEFLECTION	 Distanza tra gli appoggi "L" in metri / Pitch "L" in metres between the supports																		
		freccia / deflection	1,50	1,75	2,00	2,25	2,50	2,75	3,00	3,25	3,50	3,75	4,00	4,25	4,50	4,75	5,00	5,25	5,50	5,75
0,60	q lim SLU	455	359	292	242	204	174	151	132	116	103	92	83	75	68	62	57	53	49	45
	q lim (L/180*)	455	359	292	242	204	174	151	132	116	103	92	83	75	65	53	43	36	30	25
	q lim (L/200)	455	359	292	242	204	174	151	132	116	103	92	83	75	68	62	57	50	43	38
	q lim (L/250)	455	359	292	242	204	174	151	132	116	103	92	83	72	62	53	46	40	35	31
	q lim (L/300)	455	359	292	242	204	174	151	132	116	103	86	72	60	51	44	38	33	29	25
0,80	q lim SLU	758	600	487	404	341	292	252	221	195	173	155	139	126	115	105	96	88	82	76
	q lim (L/180*)	758	600	487	404	341	292	252	221	195	173	155	139	118	95	77	63	53	44	37
	q lim (L/200)	758	600	487	404	341	292	252	221	195	173	155	139	126	112	96	83	72	63	56
	q lim (L/250)	758	600	487	404	341	292	252	221	195	173	151	126	106	90	77	67	58	51	45
	q lim (L/300)	758	600	487	404	341	292	252	221	187	152	125	105	88	75	64	56	48	42	37
1,00	q lim SLU	1110	878	713	591	499	427	369	323	285	253	227	204	185	168	153	141	129	119	110
	q lim (L/180*)	1110	878	713	591	499	427	369	323	285	253	227	198	158	127	103	85	71	59	50
	q lim (L/200)	1110	878	713	591	499	427	369	323	285	253	227	204	177	151	129	112	97	85	75
	q lim (L/250)	1110	878	713	591	499	427	369	323	285	245	202	168	142	121	103	89	78	68	60
	q lim (L/300)	1110	878	713	591	499	427	369	314	251	204	168	140	118	100	86	74	65	57	50
1,25	q lim SLU	1553	1224	991	820	690	589	509	445	392	348	311	279	253	230	209	192	176	161	148
	q lim (L/180*)	1553	1224	991	820	690	589	509	445	392	348	311	261	208	167	136	112	93	78	66
	q lim (L/200)	1553	1224	991	820	690	589	509	445	392	348	311	277	234	199	170	147	128	112	99
	q lim (L/250)	1553	1224	991	820	690	589	509	445	392	323	266	222	187	159	136	118	102	90	79
	q lim (L/300)	1553	1224	991	820	690	589	509	414	331	269	222	185	156	133	114	98	85	75	66
1,50	q lim SLU	2010	1578	1274	1051	883	752	648	565	497	441	393	353	319	290	263	239	217	199	183
	q lim (L/180*)	2010	1578	1274	1051	883	752	648	565	497	441	393	313	249	200	163	134	112	93	79
	q lim (L/200)	2010	1578	1274	1051	883	752	648	565	497	441	393	332	280	238	204	176	153	134	118
	q lim (L/250)	2010	1578	1274	1051	883	752	648	565	476	387	319	266	224	190	163	141	123	107	94
	q lim (L/300)	2010	1578	1274	1051	883	752	630	495	397	323	266	222	187	159	136	118	102	89	79
LEGENDA / INDEX																				
Valori carico ammissibile uniformemente distribuito Distributed load and resistance factor design	>	Per la condizione di Stato Limite Ultimo (SLU) della lamiera / <i>Ultimate limit-state design of the corrugated sheet (SLU)</i>																		
	>	Per la condizione di Stato Limite di Esercizio (SLE) della lamiera ($F \leq L/180; L/200; L/250; L/300$) / <i>Serviceability limit of the corrugated sheet (SLE) ($F \leq L/180; L/200; L/250; L/300$)</i>																		
	>	Per la condizione di Stato Limite di Esercizio (SLE) della lamiera ($F \leq$ *solo max 20mm) / <i>Serviceability limit of the corrugated sheet (SLE) ($F \leq$ only max 20mm)</i>																		

I rapporti di prova pubblicati in questo catalogo vengono forniti a titolo puramente indicativo. I dati pubblicati sono stati calcolati secondo le Norme vigenti: NTC2018, Circolare esplicativa alle NTC2018, UNI EN 1993 (EC3). Per una corretta applicazione del prodotto sarà onere e cura del cliente e/o del progettista la redazione di calcoli appropriati con specifico riferimento al singolo impiego.

The test reports published in this catalogue are provided for indicative purposes only. The published data have been calculated according to the current regulations: NTC2018, Explanatory circular to NTC2018, UNI EN 1993 (EC3). For a correct application of the product, it will be responsibility and care of the customer and/or the designer to draw up appropriate calculations with specific reference to the individual use.

TECNODEC 105 / LAMIERA DA SOLAIO - SLAB CORRUGATED SHEET



CLASSE / CLASS



THE INTERNATIONAL EPD® SYSTEM
PRODOTTI CERTIFICATI EPD
Criteri Ambientali Minimi (CAM)

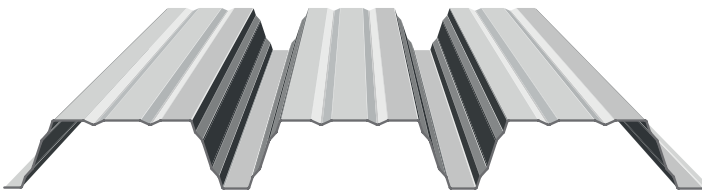

Lamiera grecata per coperture su grandi luci. I profili Tecnodec sono il completamento ideale per i fabbricati della logistica nella grande distribuzione organizzata.

Corrugated metal sheet for roofs of large spans. Tecnodec profiles are the ideal completion for logistics buildings in the large organized distribution sector.

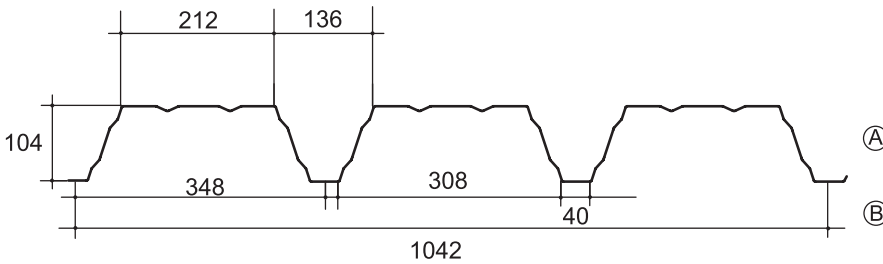

Nei disegni, A o B indicano il lato preverniciato desiderato.
In the drawings A or B show the wished prepainted side.

Nome del prodotto Product name	Numero greche Number of ribs	Interasse greche Pitch	Altezza greca Rib height	Larghezza greca Rib width	Base greca Rib long base	Larghezza modulo Covering width	Numero greche di sormonto Rib overlap
	(nr)	(mm)	(mm)	(mm)	(mm)	(mm)	(nr)
TECNODEC 105	2	348	104	40	212	1042	1

Caratteristiche tecniche - Datasheet

Dimensioni: larghezza 1042 (mm), lunghezza a richiesta da produzione in continuo.

Spessori: fino a mm 1,5 - anche non standard su richiesta.

Alcune tipologie di acciaio, fornibili a richiesta previo accordo sui quantitativi minimi: S 235; S 250 GD+Z; S 260 NC; S 275; S 280 GD+Z; S 315 MC; S 315 NC; S 320 GD+Z (ed altri ancora).

Supporti: acciaio zincato preverniciato o plastificato;

Trattamenti protettivi applicabili a richiesta: Preverniciatura con poliestere, superpoliestere (hd) Disponibilità su richiesta di altri film e rivestimenti.

Dimensions: width 1042 (mm), length upon request from continuous production process.

Thicknesses (S): up to mm 1,5 - also non-standard on request.

Some types of steel supplied upon request previous agreement on minimum quantities: S 235; S 250 GD+Z; S 260 NC; S 275; S 280 GD+Z; S 315 MC; S 315 NC; S 320 GD+Z (and others more).

Supports: prepainted or plasticized galvanized steel;

Protective treatments for external support available on request: Pre-painting with polyester, superpolyester (hd). Availability on request of other films and coatings.

TECNODEC 105 - ACCIAIO S 250 GD+Z / STEEL S 250 GD+Z CARATTERISTICHE STATICHE / STATIC CHARACTERISTICS													
spessore lamiera - sheet metal thickness	Peso weight [kg/m ²]	PROPRIETA' DI MASSA LORDE: GROSS MASS PROPERTY:				PROPRIETA' DI MASSA EFFICACI: - EFFECTIVE MASS PROPERTIES:							
		A	J _{xG}	W _{e sup}	W _{e inf}	MOMENTO POSITIVO IN CAMPATA POSITIVE MOMENT ON SPAN				MOMENTO NEGATIVO SULL'APPOGGIO NEGATIVE MOMENT ON SUPPORT			
						A _{eff}	J _{xG eff}	W _{e sup eff}	W _{e inf eff}	A _{eff}	J _{xG eff}	W _{e sup eff}	W _{e inf eff}
						cm ² /m	cm ⁴ /m	cm ³ /m	cm ³ /m	cm ² /m	cm ⁴ /m	cm ³ /m	cm ³ /m
0,75	8,4	10,485	153,829	45,925	21,818	8,257	123,733	29,261	20,049	8,585	115,598	46,276	14,629
0,8	9,0	11,184	164,086	48,987	23,273	8,946	134,366	32,270	21,546	9,362	128,038	49,374	16,401
0,88	9,9	12,302	180,497	53,887	25,601	10,079	151,751	37,318	23,960	10,643	148,639	54,325	19,395
1,0	11,2	13,980	205,114	61,236	29,092	11,846	178,585	45,403	27,616	12,645	180,964	61,750	24,227
1,25	14,0	17,474	256,405	76,549	36,367	14,980	225,570	57,975	34,654	16,946	247,180	76,729	34,433
1,5	16,8	20,969	307,705	91,864	43,643	17,974	270,306	69,417	41,547	20,969	307,705	91,864	43,643

TABELLA DI PORTATA TECNODEC 105: ACCIAIO S 250 GD / LOAD TABLE TECNODEC 105: STEEL S 250 GD

I valori di portata in tabella non includono il peso proprio della lamiera grecata.
The capacity load shown in the table does not include the weight of the metal sheet itself.

TABELLA DI PORTATA TECNODEC 105 NORMALE: ACCIAIO S 250 GD / LOAD TABLE TECNODEC 105 NORMAL POSITION: STEEL S 250 GD																				
Appoggio esterno 100 mm; appoggio interno (non presente) / End support 100 mm; internal support (not present)																				
Coefficienti di sicurezza sulle portate allo SLU (γ_q): 1,40 / Safety coefficient applied to SLU (γ_q): 1,40																				
PORTATA DEL PROFILO IN daN/m ² CON FRECCIA \leq L/200; L/250; L/300; L/350 / SHEET CAPACITY, daN/m ² WITH DEFLECTION \leq L/200; L/250; L/300; L/350 OF A SPAN																				
Spessore / thickness	(q) CARICO LIMITE LIMIT DESIGN DEFLECTION																			
		Distanza tra gli appoggi "L" in metri / Pitch "L" in metres between the supports																		
mm	freccia / deflection	2,60	2,80	3,00	3,20	3,40	3,60	3,80	4,00	4,20	4,40	4,60	4,80	5,00	5,20	5,40	5,60	5,80	6,00	6,20
0,75	q lim SLU	233	216	202	189	178	168	160	152	144	138	131	121	111	103	95	89	83	77	72
	q lim (L/200)	233	216	202	189	178	168	160	152	137	119	104	92	81	72	65	58	52	47	43
	q lim (L/250)	233	216	202	189	178	168	148	127	110	96	84	74	65	58	52	46	42	38	34
	q lim (L/300)	233	216	202	189	173	145	124	106	92	80	70	61	54	48	43	39	35	31	28
	q lim (L/350)	233	216	202	177	148	125	106	91	78	68	60	53	46	41	37	33	30	27	24
0,80	q lim SLU	263	244	228	213	201	190	180	171	163	154	141	130	120	111	102	95	89	83	78
	q lim (L/200)	263	244	228	213	201	190	180	171	149	130	113	100	88	79	70	63	57	51	46
	q lim (L/250)	263	244	228	213	201	189	161	138	119	104	91	80	71	63	56	50	45	41	37
	q lim (L/300)	263	244	228	213	187	158	134	115	99	86	76	67	59	52	47	42	38	34	31
	q lim (L/350)	263	244	228	193	161	135	115	99	85	74	65	57	50	45	40	36	32	29	26
0,88	q lim SLU	313	291	271	254	239	226	214	203	188	172	157	144	133	123	114	106	99	92	86
	q lim (L/200)	313	291	271	254	239	226	214	195	168	146	128	113	100	89	79	71	64	58	52
	q lim (L/250)	313	291	271	254	239	214	182	156	135	117	103	90	80	71	63	57	51	46	42
	q lim (L/300)	313	291	271	254	212	178	152	130	112	98	85	75	67	59	53	47	43	39	35
	q lim (L/350)	313	291	264	218	181	153	130	111	96	84	73	64	57	51	45	41	37	33	30
1,00	q lim SLU	396	368	343	322	303	286	265	239	217	198	181	166	153	142	131	122	114	106	100
	q lim (L/200)	396	368	343	322	303	286	265	229	198	172	151	133	117	104	93	84	75	68	62
	q lim (L/250)	396	368	343	322	299	252	214	184	159	138	121	106	94	84	75	67	60	54	49
	q lim (L/300)	396	368	343	299	249	210	178	153	132	115	101	88	78	70	62	56	50	45	41
	q lim (L/350)	396	368	311	256	213	180	153	131	113	98	86	76	67	60	53	48	43	39	35
1,25	q lim SLU	599	556	519	469	416	371	333	300	272	248	227	209	192	178	165	153	143	134	125
	q lim (L/200)	599	556	519	469	416	371	333	290	250	218	190	168	148	132	118	106	95	86	78
	q lim (L/250)	599	556	519	453	377	318	270	232	200	174	152	134	119	105	94	84	76	69	62
	q lim (L/300)	599	556	458	377	315	265	225	193	167	145	127	112	99	88	79	70	63	57	52
	q lim (L/350)	599	483	392	323	270	227	193	166	143	124	109	96	85	75	67	60	54	49	44
1,50	q lim SLU	839	735	640	563	498	445	399	360	327	298	272	250	230	213	198	184	171	160	150
	q lim (L/200)	839	735	640	563	498	445	399	347	300	261	228	201	178	158	141	127	114	103	93
	q lim (L/250)	839	735	640	542	452	381	324	278	240	209	183	161	142	126	113	101	91	82	75
	q lim (L/300)	839	675	549	452	377	317	270	231	200	174	152	134	119	105	94	84	76	69	62
	q lim (L/350)	722	578	470	387	323	272	231	198	171	149	130	115	102	90	81	72	65	59	53
LEGENDA / INDEX																				
Valori carico ammissibile uniformemente distribuito Distributed load and resistance factor design	>	Per la condizione di Stato Limite Ultimo (SLU) della lamiera / <i>Ultimate limit-state design of the corrugated sheet (SLU)</i>																		
	>	Per la condizione di Stato Limite di Esercizio (SLE) della lamiera ($F \leq$ L/200; L/250; L/300; L/350) / <i>Serviceability limit of the corrugated sheet (SLE) ($F \leq$ L/200; L/250; L/300; L/350)</i>																		

LAMIERE DA SOLAIO
SLAB CORRUGATED SHEETS

I rapporti di prova pubblicati in questo catalogo vengono forniti a titolo puramente indicativo. I dati pubblicati sono stati calcolati secondo le Norme vigenti: NTC2018, Circolare esplicativa alle NTC2018, UNI EN 1993 (EC3). Per una corretta applicazione del prodotto sarà onere e cura del cliente e/o del progettista la redazione di calcoli appropriati con specifico riferimento al singolo impiego.

The test reports published in this catalogue are provided for indicative purposes only. The published data have been calculated according to the current regulations: NTC2018, Explanatory circular to NTC2018, UNI EN 1993 (EC3). For a correct application of the product, it will be responsibility and care of the customer and/or the designer to draw up appropriate calculations with specific reference to the individual use.

TABELLA PORTATA TECNODEC 105: ACCIAIO S 250 GD / LOAD TABLE TECNODEC 105: STEEL S 250 GD

I valori di portata in tabella non includono il peso proprio della lamiera grecata.
The capacity load shown in the table does not include the weight of the metal sheet itself.

TABELLA DI PORTATA TECNODEC 105 NORMALE: ACCIAIO S 250 GD / LOAD TABLE TECNODEC 105 NORMAL POSITION: STEEL S 250 GD																				
Appoggio esterno 100 mm; appoggio interno 100 mm / End support 100 mm; internal support 100 mm																				
Coefficienti di sicurezza sulle portate allo SLU (γ_q): 1,40 / Safety coefficient applied to SLU (γ_q): 1,40																				
PORTATA DEL PROFILO IN daN/m ² CON FRECCIA \leq L/200; L/250; L/300; L/350 / SHEET CAPACITY, daN/m ² WITH DEFLECTION \leq L/200; L/250; L/300; L/350 OF A SPAN																				
Spessore / thickness	(q) CARICO LIMITE LIMIT DESIGN DEFLECTION																			
		Distanza tra gli appoggi "L" in metri / Pitch "L" in metres between the supports																		
mm	freccia / deflection	2,60	2,80	3,00	3,20	3,40	3,60	3,80	4,00	4,20	4,40	4,60	4,80	5,00	5,20	5,40	5,60	5,80	6,00	6,20
0,75	q lim SLU	212	189	169	153	138	126	115	106	97	90	84	78	73	68	64	60	56	53	50
	q lim (L/200)	212	189	169	153	138	126	115	106	97	90	84	78	73	68	64	60	56	53	50
	q lim (L/250)	212	189	169	153	138	126	115	106	97	90	84	78	73	68	64	60	56	53	50
	q lim (L/300)	212	189	169	153	138	126	115	106	97	90	84	78	73	68	64	60	56	53	50
	q lim (L/350)	212	189	169	153	138	126	115	106	97	90	84	78	73	68	64	60	56	53	50
0,80	q lim SLU	238	212	190	171	155	141	129	118	109	101	94	87	81	76	71	67	63	59	56
	q lim (L/200)	238	212	190	171	155	141	129	118	109	101	94	87	81	76	71	67	63	59	56
	q lim (L/250)	238	212	190	171	155	141	129	118	109	101	94	87	81	76	71	67	63	59	56
	q lim (L/300)	238	212	190	171	155	141	129	118	109	101	94	87	81	76	71	67	63	59	56
	q lim (L/350)	238	212	190	171	155	141	129	118	109	101	94	87	81	76	71	67	63	59	56
0,88	q lim SLU	281	250	224	202	183	166	152	140	129	119	111	103	96	90	84	79	74	70	66
	q lim (L/200)	281	250	224	202	183	166	152	140	129	119	111	103	96	90	84	79	74	70	66
	q lim (L/250)	281	250	224	202	183	166	152	140	129	119	111	103	96	90	84	79	74	70	66
	q lim (L/300)	281	250	224	202	183	166	152	140	129	119	111	103	96	90	84	79	74	70	66
	q lim (L/350)	281	250	224	202	183	166	152	140	129	119	111	103	96	90	84	79	74	70	66
1,00	q lim SLU	350	311	279	252	228	208	190	175	161	149	138	128	120	112	105	98	93	87	82
	q lim (L/200)	350	311	279	252	228	208	190	175	161	149	138	128	120	112	105	98	93	87	82
	q lim (L/250)	350	311	279	252	228	208	190	175	161	149	138	128	120	112	105	98	93	87	82
	q lim (L/300)	350	311	279	252	228	208	190	175	161	149	138	128	120	112	105	98	93	87	82
	q lim (L/350)	350	311	279	252	228	208	190	175	161	149	138	128	120	112	105	98	93	87	82
1,25	q lim SLU	504	448	402	362	328	298	273	251	231	213	198	184	172	160	150	141	133	125	118
	q lim (L/200)	504	448	402	362	328	298	273	251	231	213	198	184	172	160	150	141	133	125	118
	q lim (L/250)	504	448	402	362	328	298	273	251	231	213	198	184	172	160	150	141	133	125	118
	q lim (L/300)	504	448	402	362	328	298	273	251	231	213	198	184	172	160	150	141	133	125	118
	q lim (L/350)	504	448	402	362	328	298	273	251	231	213	198	184	172	160	150	141	132	120	108
1,50	q lim SLU	659	586	524	472	427	388	355	325	300	277	256	238	222	207	194	182	171	161	152
	q lim (L/200)	659	586	524	472	427	388	355	325	300	277	256	238	222	207	194	182	171	161	152
	q lim (L/250)	659	586	524	472	427	388	355	325	300	277	256	238	222	207	194	182	171	161	152
	q lim (L/300)	659	586	524	472	427	388	355	325	300	277	256	238	222	207	194	182	171	161	152
	q lim (L/350)	659	586	524	472	427	388	355	325	300	277	256	238	222	207	194	176	159	143	130

LEGENDA / INDEX

Valori carico ammissibile uniformemente distribuito <i>Distributed load and resistance factor design</i>	>	Per la condizione di Stato Limite Ultimo (SLU) della lamiera / <i>Ultimate limit-state design of the corrugated sheet (SLU)</i>
	>	Per la condizione di Stato Limite di Esercizio (SLE) della lamiera ($F \leq$ L/200; L/250; L/200; L/350) / <i>Serviceability limit of the corrugated sheet (SLE) ($F \leq$ L/200; L/250; L/300; L/350)</i>

I rapporti di prova pubblicati in questo catalogo vengono forniti a titolo puramente indicativo. I dati pubblicati sono stati calcolati secondo le Norme vigenti: NTC2018, Circolare esplicativa alle NTC2018, UNI EN 1993 (EC3). Per una corretta applicazione del prodotto sarà onere e cura del cliente e/o del progettista la redazione di calcoli appropriati con specifico riferimento al singolo impiego.

The test reports published in this catalogue are provided for indicative purposes only. The published data have been calculated according to the current regulations: NTC2018, Explanatory circular to NTC2018, UNI EN 1993 (EC3). For a correct application of the product, it will be responsibility and care of the customer and/or the designer to draw up appropriate calculations with specific reference to the individual use.

TABELLA PORTATA TECNODEC 105: ACCIAIO S 250 GD / LOAD TABLE TECNODEC 105: STEEL S 250 GD

I valori di portata in tabella non includono il peso proprio della lamiera grecata.
The capacity load shown in the table does not include the weight of the metal sheet itself.

TABELLA DI PORTATA TECNODEC 105 NORMALE (DECK): ACCIAIO S 250 GD / LOAD TABLE TECNODEC 105 NORMAL POSITION: STEEL S 250 GD																				
Appoggio esterno 100 mm; appoggio interno 100 mm / End support 100 mm; internal support 100 mm																				
Coefficienti di sicurezza sulle portate allo SLU (γ_q): 1,40 / Safety coefficient applied to SLU (γ_q): 1,40																				
PORTATA DEL PROFILO IN daN/m ² CON FRECCIA \leq L/200; L/250; L/300; L/350 / SHEET CAPACITY, daN/m ² WITH DEFLECTION \leq L/200; L/250; L/300; L/350 OF A SPAN																				
Spessore / thickness	(q) CARICO LIMITE LIMIT DESIGN DEFLECTION																			
		Distanza tra gli appoggi "L" in metri / Pitch "L" in metres between the supports																		
mm	freccia / deflection	2,60	2,80	3,00	3,20	3,40	3,60	3,80	4,00	4,20	4,40	4,60	4,80	5,00	5,20	5,40	5,60	5,80	6,00	6,20
0,75	q lim SLU	254	227	203	184	167	152	139	128	118	109	101	94	88	82	77	73	68	64	61
	q lim (L/200)	254	227	203	184	167	152	139	128	118	109	101	94	88	82	77	73	68	64	61
	q lim (L/250)	254	227	203	184	167	152	139	128	118	109	101	94	88	82	77	73	68	64	61
	q lim (L/300)	254	227	203	184	167	152	139	128	118	109	101	94	88	82	77	73	67	60	54
	q lim (L/350)	254	227	203	184	167	152	139	128	118	109	101	94	88	79	71	63	57	52	47
0,80	q lim SLU	285	254	228	206	187	170	156	143	132	122	114	106	99	92	87	81	77	72	68
	q lim (L/200)	285	254	228	206	187	170	156	143	132	122	114	106	99	92	87	81	77	72	68
	q lim (L/250)	285	254	228	206	187	170	156	143	132	122	114	106	99	92	87	81	77	72	68
	q lim (L/300)	285	254	228	206	187	170	156	143	132	122	114	106	99	92	87	80	72	65	59
	q lim (L/350)	285	254	228	206	187	170	156	143	132	122	114	106	97	86	77	69	62	56	51
0,88	q lim SLU	336	300	269	243	220	201	184	169	156	144	134	125	117	109	102	96	90	85	81
	q lim (L/200)	336	300	269	243	220	201	184	169	156	144	134	125	117	109	102	96	90	85	81
	q lim (L/250)	336	300	269	243	220	201	184	169	156	144	134	125	117	109	102	96	90	85	80
	q lim (L/300)	336	300	269	243	220	201	184	169	156	144	134	125	117	109	101	91	82	74	67
	q lim (L/350)	336	300	269	243	220	201	184	169	156	144	134	123	109	97	87	78	70	63	57
1,00	q lim SLU	419	374	335	303	275	251	230	211	195	180	167	156	145	136	128	120	113	106	101
	q lim (L/200)	419	374	335	303	275	251	230	211	195	180	167	156	145	136	128	120	113	106	101
	q lim (L/250)	419	374	335	303	275	251	230	211	195	180	167	156	145	136	128	120	113	104	94
	q lim (L/300)	419	374	335	303	275	251	230	211	195	180	167	156	145	133	119	107	96	87	79
	q lim (L/350)	419	374	335	303	275	251	230	211	195	180	165	145	129	114	102	91	82	74	67
1,25	q lim SLU	604	538	483	436	395	360	330	303	280	259	240	224	209	195	183	172	162	153	144
	q lim (L/200)	604	538	483	436	395	360	330	303	280	259	240	224	209	195	183	172	162	153	144
	q lim (L/250)	604	538	483	436	395	360	330	303	280	259	240	224	209	195	180	162	146	132	119
	q lim (L/300)	604	538	483	436	395	360	330	303	280	259	240	214	189	168	150	135	121	110	99
	q lim (L/350)	604	538	483	436	395	360	330	303	274	238	208	183	162	144	129	116	104	94	85
1,50	q lim SLU	792	704	631	569	516	470	430	394	364	336	312	290	270	253	237	222	209	197	186
	q lim (L/200)	792	704	631	569	516	470	430	394	364	336	312	290	270	253	237	222	209	197	179
	q lim (L/250)	792	704	631	569	516	470	430	394	364	336	312	290	270	242	216	194	174	158	143
	q lim (L/300)	792	704	631	569	516	470	430	394	364	333	291	256	227	202	180	162	145	131	119
	q lim (L/350)	792	704	631	569	516	470	430	380	328	285	250	220	194	173	154	138	125	113	102
LEGENDA / INDEX																				
Valori carico ammissibile uniformemente distribuito <i>Distributed load and resistance factor design</i>	>	Per la condizione di Stato Limite Ultimo (SLU) della lamiera / <i>Ultimate limit-state design of the corrugated sheet (SLU)</i>																		
	>	Per la condizione di Stato Limite di Esercizio (SLE) della lamiera ($F \leq$ L/200; L/250; L/200; L/350) / <i>Serviceability limit of the corrugated sheet (SLE) ($F \leq$ L/200; L/250; L/300; L/350)</i>																		

LAMIERE DA SOLAIO
SLAB CORRUGATED SHEETS

I rapporti di prova pubblicati in questo catalogo vengono forniti a titolo puramente indicativo. I dati pubblicati sono stati calcolati secondo le Norme vigenti: NTC2018, Circolare esplicativa alle NTC2018, UNI EN 1993 (EC3). Per una corretta applicazione del prodotto sarà onere e cura del cliente e/o del progettista la redazione di calcoli appropriati con specifico riferimento al singolo impiego.

The test reports published in this catalogue are provided for indicative purposes only. The published data have been calculated according to the current regulations: NTC2018, Explanatory circular to NTC2018, UNI EN 1993 (EC3). For a correct application of the product, it will be responsibility and care of the customer and/or the designer to draw up appropriate calculations with specific reference to the individual use.

TECNODEC 150 / LAMIERA DA SOLAIO - SLAB CORRUGATED SHEET



CLASSE / CLASS

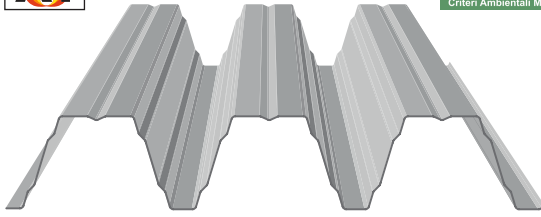

Lamiera grecata per coperture su grandi luci. I profili Tecnodec sono il completamento ideale per i fabbricati della logistica nella grande distribuzione organizzata.

Corrugated metal sheet for roofs of large spans. Tecnodec profiles are the ideal completion for logistics buildings in the large organized distribution sector.

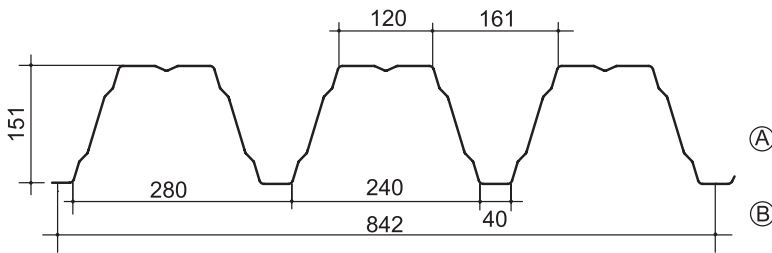

Nei disegni, A o B indicano il lato preverniciato desiderato.
In the drawings A or B show the wished pre-painted side.

Nome del prodotto Product name	Numero greche Number of ribs	Interasse greche Pitch	Altezza greca Rib height	Larghezza greca Rib width	Base greca Rib long base	Larghezza modulo Covering width	Numero greche di sormonto Rib overlap
	(nr)	(mm)	(mm)	(mm)	(mm)	(mm)	(nr)
TECNODEC 150	2	280,79	151	40	120	842	1

Caratteristiche tecniche - Datasheet

Dimensioni: larghezza 842 (mm), lunghezza a richiesta da produzione in continuo.

Spessori: fino a mm 1,5 - anche non standard su richiesta.

Alcune tipologie di acciaio, fornibili a richiesta previo accordo sui quantitativi minimi: S 235; S 250 GD+Z; S 260 NC; S 275; S 280 GD+Z; S 315 MC; S 315 NC; S 320 GD+Z (ed altri ancora).

Supporti: acciaio zincato preverniciato o plastificato;
Trattamenti protettivi applicabili a richiesta: Preverniciatura con poliestere, superpoliestere (hd) Disponibilità su richiesta di altri film e rivestimenti.

Dimensions: width 842 (mm), length upon request from continuous production process.

Thicknesses (S): up to mm 1,5 - also non-standard on request.

Some types of steel supplied upon request previous agreement on minimum quantities: S 235; S 250 GD+Z; S 260 NC; S 275; S 280 GD+Z; S 315 MC; S 315 NC; S 320 GD+Z (and others more).

Supports: pre-painted or plasticized galvanized steel;
Protective treatments for external support available on request: Pre-painting with polyester, superpolyester (hd). Availability on request of other films and coatings.

TECNODEC 150 - ACCIAIO S 250 GD+Z / STEEL S 250 GD+Z CARATTERISTICHE STATICHE / STATIC CHARACTERISTICS																	
spessore lamiera - sheet metal thickness	Peso weight	PROPRIETA' DI MASSA EFFICACI: - EFFECTIVE MASS PROPERTIES:															
		PROPRIETA' DI MASSA LORDE: GROSS MASS PROPERTY:				MOMENTO POSITIVO IN CAMPATA POSITIVE MOMENT ON SPAN								MOMENTO NEGATIVO SULL'APPOGGIO NEGATIVE MOMENT ON SUPPORT			
		A	J _{xG}	W _{e sup}	W _{e inf}	A _{eff}	J _{xG eff}	W _{e sup eff}	W _{e inf eff}	A _{eff}	J _{xG eff}	W _{e sup eff}	W _{e inf eff}				
		cm ² /m	cm ⁴ /m	cm ³ /m	cm ³ /m	cm ² /m	cm ⁴ /m	cm ³ /m	cm ³ /m	cm ² /m	cm ⁴ /m	cm ³ /m	cm ³ /m				
0,75	10,4	13,026	387,956	61,635	44,058	10,660	311,358	42,057	40,453	9,288	276,719	60,459	26,297				
0,8	11,1	13,894	413,821	65,745	46,995	11,641	341,136	46,909	43,581	10,201	305,843	64,718	29,481				
0,88	12,2	15,284	455,207	72,320	51,695	13,270	389,918	55,083	48,610	11,717	353,902	71,531	34,859				
1,0	13,9	17,368	517,286	82,182	58,745	15,843	465,352	68,230	56,204	14,110	428,926	81,747	43,533				
1,25	17,4	21,710	646,627	102,731	73,433	20,958	616,944	94,685	71,869	19,291	581,286	102,195	61,760				
1,5	20,8	26,052	775,979	123,281	88,123	25,473	753,383	117,081	86,943	24,903	742,924	122,707	82,131				

TABELLA PORTATA TECNODEC 150: ACCIAIO S 250 GD / LOAD TABLE TECNODEC 150: STEEL S 250 GD

I valori di portata in tabella non includono il peso proprio della lamiera grecata.
The capacity load shown in the table does not include the weight of the metal sheet itself.

TABELLA DI PORTATA TECNODEC 150 NORMALE: ACCIAIO S 250 GD / LOAD TABLE TECNODEC 150 NORMAL POSITION: STEEL S 250 GD																				
Appoggio esterno 100 mm; appoggio interno (non presente) / End support 100 mm; internal support (not present)																				
Coefficients di sicurezza sulle portate allo SLU (γ_q): 1,40 / Safety coefficient applied to SLU (γ_q): 1,40																				
PORTATA DEL PROFILO IN daN/m ² CON FRECCIA \leq L/200; L/250; L/300; L/350 / SHEET CAPACITY, daN/m ² WITH DEFLECTION \leq L/200; L/250; L/300; L/350 OF A SPAN																				
Spessore / thickness	(q) CARICO LIMITE LIMIT DESIGN DEFLECTION																			
		Distanza tra gli appoggi "L" in metri / Pitch "L" in metres between the supports																		
mm	freccia / deflection	2,60	2,80	3,00	3,20	3,40	3,60	3,80	4,00	4,20	4,40	4,60	4,80	5,00	5,20	5,40	5,60	5,80	6,00	6,20
0,75	q lim SLU	294	273	255	239	225	212	201	191	182	174	166	159	153	147	141	136	132	127	123
	q lim (L/200)	294	273	255	239	225	212	201	191	182	174	166	159	153	147	141	136	131	118	107
	q lim (L/250)	294	273	255	239	225	212	201	191	182	174	166	159	153	146	130	117	105	95	86
	q lim (L/300)	294	273	255	239	225	212	201	191	182	174	166	154	137	121	108	97	87	79	72
	q lim (L/350)	294	273	255	239	225	212	201	191	182	172	150	132	117	104	93	83	75	68	61
0,80	q lim SLU	331	307	287	269	253	239	226	215	205	196	187	179	172	165	159	154	148	143	139
	q lim (L/200)	331	307	287	269	253	239	226	215	205	196	187	179	172	165	159	154	144	130	118
	q lim (L/250)	331	307	287	269	253	239	226	215	205	196	187	179	172	160	142	128	115	104	94
	q lim (L/300)	331	307	287	269	253	239	226	215	205	196	187	169	150	133	119	106	96	87	78
	q lim (L/350)	331	307	287	269	253	239	226	215	205	188	165	145	128	114	102	91	82	74	67
0,88	q lim SLU	394	366	342	321	302	285	270	256	244	233	223	214	205	197	190	183	177	171	165
	q lim (L/200)	394	366	342	321	302	285	270	256	244	233	223	214	205	197	190	183	164	148	134
	q lim (L/250)	394	366	342	321	302	285	270	256	244	233	223	214	205	182	163	146	131	119	108
	q lim (L/300)	394	366	342	321	302	285	270	256	244	233	220	193	171	152	136	122	110	99	90
	q lim (L/350)	394	366	342	321	302	285	270	256	244	215	188	166	147	130	116	104	94	85	77
1,00	q lim SLU	499	464	433	406	382	361	342	325	309	295	282	271	260	250	240	232	224	216	203
	q lim (L/200)	499	464	433	406	382	361	342	325	309	295	282	271	260	250	240	218	196	177	161
	q lim (L/250)	499	464	433	406	382	361	342	325	309	295	282	271	245	218	194	174	157	142	128
	q lim (L/300)	499	464	433	406	382	361	342	325	309	295	262	231	204	181	162	145	131	118	107
	q lim (L/350)	499	464	433	406	382	361	342	325	295	257	225	198	175	155	139	124	112	101	92
1,25	q lim SLU	754	700	654	613	577	545	516	490	467	446	426	409	392	369	342	318	296	277	259
	q lim (L/200)	754	700	654	613	577	545	516	490	467	446	426	409	392	361	322	289	260	235	213
	q lim (L/250)	754	700	654	613	577	545	516	490	467	446	417	367	325	289	258	231	208	188	170
	q lim (L/300)	754	700	654	613	577	545	516	490	456	397	347	306	270	240	215	193	173	157	142
	q lim (L/350)	754	700	654	613	577	545	516	453	391	340	298	262	232	206	184	165	149	134	122
1,50	q lim SLU	1083	1005	938	880	828	782	741	704	670	640	605	556	512	474	439	409	381	356	333
	q lim (L/200)	1083	1005	938	880	828	782	741	704	670	640	605	556	510	454	405	363	327	295	268
	q lim (L/250)	1083	1005	938	880	828	782	741	704	670	599	524	461	408	363	324	291	262	236	214
	q lim (L/300)	1083	1005	938	880	828	782	741	664	574	499	437	385	340	302	270	242	218	197	178
	q lim (L/350)	1083	1005	938	880	828	781	664	570	492	428	374	330	292	259	231	208	187	169	153

LEGENDA / INDEX

Valori carico ammissibile uniformemente distribuito
Distributed load and resistance factor design

>

Per la condizione di Stato Limite Ultimo (SLU) della lamiera / *Ultimate limit-state design of the corrugated sheet (SLU)*

>

Per la condizione di Stato Limite di Esercizio (SLE) della lamiera ($F \leq$ L/200; L/250; L/300; L/350) / *Serviceability limit of the corrugated sheet (SLE) ($F \leq$ L/200; L/250; L/300; L/350)*

I rapporti di prova pubblicati in questo catalogo vengono forniti a titolo puramente indicativo. I dati pubblicati sono stati calcolati secondo le Norme vigenti: NTC2018, Circolare esplicativa alle NTC2018, UNI EN 1993 (EC3). Per una corretta applicazione del prodotto sarà onere e cura del cliente e/o del progettista la redazione di calcoli appropriati con specifico riferimento al singolo impiego.

The test reports published in this catalogue are provided for indicative purposes only. The published data have been calculated according to the current regulations: NTC2018, Explanatory circular to NTC2018, UNI EN 1993 (EC3). For a correct application of the product, it will be responsibility and care of the customer and/or the designer to draw up appropriate calculations with specific reference to the individual use.

TABELLA PORTATA TECNODEC 150: ACCIAIO S 250 GD / LOAD TABLE TECNODEC 150: STEEL S 250 GD

I valori di portata in tabella non includono il peso proprio della lamiera grecata.
The capacity load shown in the table does not include the weight of the metal sheet itself.

TABELLA DI PORTATA TECNODEC 150 NORMALE: ACCIAIO S 250 GD / LOAD TABLE TECNODEC 150 NORMAL POSITION: STEEL S 250 GD																				
Appoggio esterno 100 mm; appoggio interno 100 mm / End support 100 mm; internal support 100 mm																				
Coefficienti di sicurezza sulle portate allo SLU (γ_q): 1,40 / Safety coefficient applied to SLU (γ_q): 1,40																				
PORTATA DEL PROFILO IN daN/m ² CON FRECCIA \leq L/200; L/250; L/300; L/350 / SHEET CAPACITY, daN /m ² WITH DEFLECTION \leq L/200; L/250; L/300; L/350 OF A SPAN																				
Spessore / thickness	(q) CARICO LIMITE LIMIT DESIGN DEFLECTION																			
		Distanza tra gli appoggi "L" in metri / Pitch "L" in metres between the supports																		
mm	freccia / deflection	2,60	2,80	3,00	3,20	3,40	3,60	3,80	4,00	4,20	4,40	4,60	4,80	5,00	5,20	5,40	5,60	5,80	6,00	6,20
0,75	q lim SLU	322	288	260	236	215	197	181	167	154	143	133	124	116	109	102	96	91	86	81
	q lim (L/200)	322	288	260	236	215	197	181	167	154	143	133	124	116	109	102	96	91	86	81
	q lim (L/250)	322	288	260	236	215	197	181	167	154	143	133	124	116	109	102	96	91	86	81
	q lim (L/300)	322	288	260	236	215	197	181	167	154	143	133	124	116	109	102	96	91	86	81
	q lim (L/350)	322	288	260	236	215	197	181	167	154	143	133	124	116	109	102	96	91	86	81
0,80	q lim SLU	360	323	291	264	240	220	202	186	172	160	149	139	130	122	115	108	102	96	91
	q lim (L/200)	360	323	291	264	240	220	202	186	172	160	149	139	130	122	115	108	102	96	91
	q lim (L/250)	360	323	291	264	240	220	202	186	172	160	149	139	130	122	115	108	102	96	91
	q lim (L/300)	360	323	291	264	240	220	202	186	172	160	149	139	130	122	115	108	102	96	91
	q lim (L/350)	360	323	291	264	240	220	202	186	172	160	149	139	130	122	115	108	102	96	91
0,88	q lim SLU	425	381	343	311	284	260	239	220	204	189	176	164	154	144	135	127	120	114	108
	q lim (L/200)	425	381	343	311	284	260	239	220	204	189	176	164	154	144	135	127	120	114	108
	q lim (L/250)	425	381	343	311	284	260	239	220	204	189	176	164	154	144	135	127	120	114	108
	q lim (L/300)	425	381	343	311	284	260	239	220	204	189	176	164	154	144	135	127	120	114	108
	q lim (L/350)	425	381	343	311	284	260	239	220	204	189	176	164	154	144	135	127	120	114	108
1,00	q lim SLU	530	475	428	388	354	324	297	274	254	236	219	205	192	180	169	159	150	142	134
	q lim (L/200)	530	475	428	388	354	324	297	274	254	236	219	205	192	180	169	159	150	142	134
	q lim (L/250)	530	475	428	388	354	324	297	274	254	236	219	205	192	180	169	159	150	142	134
	q lim (L/300)	530	475	428	388	354	324	297	274	254	236	219	205	192	180	169	159	150	142	134
	q lim (L/350)	530	475	428	388	354	324	297	274	254	236	219	205	192	180	169	159	150	142	134
1,25	q lim SLU	765	685	617	559	509	466	428	395	365	339	315	294	275	258	242	228	215	203	192
	q lim (L/200)	765	685	617	559	509	466	428	395	365	339	315	294	275	258	242	228	215	203	192
	q lim (L/250)	765	685	617	559	509	466	428	395	365	339	315	294	275	258	242	228	215	203	192
	q lim (L/300)	765	685	617	559	509	466	428	395	365	339	315	294	275	258	242	228	215	203	192
	q lim (L/350)	765	685	617	559	509	466	428	395	365	339	315	294	275	258	242	228	215	203	192
1,50	q lim SLU	1105	990	893	810	739	677	622	574	531	494	460	429	402	377	354	333	315	297	282
	q lim (L/200)	1105	990	893	810	739	677	622	574	531	494	460	429	402	377	354	333	315	297	282
	q lim (L/250)	1105	990	893	810	739	677	622	574	531	494	460	429	402	377	354	333	315	297	282
	q lim (L/300)	1105	990	893	810	739	677	622	574	531	494	460	429	402	377	354	333	315	297	282
	q lim (L/350)	1105	990	893	810	739	677	622	574	531	494	460	429	402	377	354	333	315	297	282
LEGENDA / INDEX																				
Valori carico ammissibile uniformemente distribuito <i>Distributed load and resistance factor design</i>	>	Per la condizione di Stato Limite Ultimo (SLU) della lamiera / <i>Ultimate limit-state design of the corrugated sheet (SLU)</i>																		
	>	Per la condizione di Stato Limite di Esercizio (SLE) della lamiera ($F \leq L/200; L/250; L/300; L/350$) / <i>Serviceability limit of the corrugated sheet (SLE) ($F \leq L/200; L/250; L/300; L/350$)</i>																		

I rapporti di prova pubblicati in questo catalogo vengono forniti a titolo puramente indicativo. I dati pubblicati sono stati calcolati secondo le Norme vigenti: NTC2018, Circolare esplicativa alle NTC2018, UNI EN 1993 (EC3). Per una corretta applicazione del prodotto sarà onere e cura del cliente e/o del progettista la redazione di calcoli appropriati con specifico riferimento al singolo impiego.

The test reports published in this catalogue are provided for indicative purposes only. The published data have been calculated according to the current regulations: NTC2018, Explanatory circular to NTC2018, UNI EN 1993 (EC3). For a correct application of the product, it will be responsibility and care of the customer and/or the designer to draw up appropriate calculations with specific reference to the individual use.

TABELLA PORTATA TECNODEC 150: ACCIAIO S 250 GD / LOAD TABLE TECNODEC 150: STEEL S 250 GD

I valori di portata in tabella non includono il peso proprio della lamiera grecata.
The capacity load shown in the table does not include the weight of the metal sheet itself.

TABELLA DI PORTATA TECNODEC 150 NORMALE (DECK): ACCIAIO S 250 GD / LOAD TABLE TECNODEC 150 NORMAL POSITION: STEEL S 250 GD																				
Appoggio esterno 100 mm; appoggio interno 100 mm / End support 100 mm; internal support 100 mm																				
Coefficienti di sicurezza sulle portate allo SLU (γ_q): 1,40 / Safety coefficient applied to SLU (γ_q): 1,40																				
PORTATA DEL PROFILO IN daN/m ² CON FRECCIA \leq L/200; L/250; L/300; L/350 / SHEET CAPACITY, daN/m ² WITH DEFLECTION \leq L/200; L/250; L/300; L/350 OF A SPAN																				
Spessore / thickness	(q) CARICO LIMITE LIMIT DESIGN DEFLECTION	 Distanza tra gli appoggi "L" in metri / Pitch "L" in metres between the supports																		
		freccia / deflection	2,60	2,80	3,00	3,20	3,40	3,60	3,80	4,00	4,20	4,40	4,60	4,80	5,00	5,20	5,40	5,60	5,80	6,00
0,75	q lim SLU	367	341	310	281	257	235	216	200	185	172	160	150	140	132	124	117	110	104	99
	q lim (L/200)	367	341	310	281	257	235	216	200	185	172	160	150	140	132	124	117	110	104	99
	q lim (L/250)	367	341	310	281	257	235	216	200	185	172	160	150	140	132	124	117	110	104	99
	q lim (L/300)	367	341	310	281	257	235	216	200	185	172	160	150	140	132	124	117	110	104	99
	q lim (L/350)	367	341	310	281	257	235	216	200	185	172	160	150	140	132	124	117	110	104	99
0,80	q lim SLU	414	384	347	315	287	263	242	224	207	193	179	168	157	147	139	131	123	116	110
	q lim (L/200)	414	384	347	315	287	263	242	224	207	193	179	168	157	147	139	131	123	116	110
	q lim (L/250)	414	384	347	315	287	263	242	224	207	193	179	168	157	147	139	131	123	116	110
	q lim (L/300)	414	384	347	315	287	263	242	224	207	193	179	168	157	147	139	131	123	116	110
	q lim (L/350)	414	384	347	315	287	263	242	224	207	193	179	168	157	147	139	131	123	116	110
0,88	q lim SLU	493	453	409	372	339	311	286	264	245	227	212	198	185	174	164	154	145	138	130
	q lim (L/200)	493	453	409	372	339	311	286	264	245	227	212	198	185	174	164	154	145	138	130
	q lim (L/250)	493	453	409	372	339	311	286	264	245	227	212	198	185	174	164	154	145	138	130
	q lim (L/300)	493	453	409	372	339	311	286	264	245	227	212	198	185	174	164	154	145	138	130
	q lim (L/350)	493	453	409	372	339	311	286	264	245	227	212	198	185	174	164	154	145	138	130
1,00	q lim SLU	624	565	510	463	423	387	357	329	305	283	264	247	231	217	204	192	181	172	162
	q lim (L/200)	624	565	510	463	423	387	357	329	305	283	264	247	231	217	204	192	181	172	162
	q lim (L/250)	624	565	510	463	423	387	357	329	305	283	264	247	231	217	204	192	181	172	162
	q lim (L/300)	624	565	510	463	423	387	357	329	305	283	264	247	231	217	204	192	181	172	162
	q lim (L/350)	624	565	510	463	423	387	357	329	305	283	264	247	231	217	204	192	181	172	162
1,25	q lim SLU	909	815	736	668	609	558	513	474	439	408	380	355	332	312	293	276	260	246	233
	q lim (L/200)	909	815	736	668	609	558	513	474	439	408	380	355	332	312	293	276	260	246	233
	q lim (L/250)	909	815	736	668	609	558	513	474	439	408	380	355	332	312	293	276	260	246	233
	q lim (L/300)	909	815	736	668	609	558	513	474	439	408	380	355	332	312	293	276	260	246	233
	q lim (L/350)	909	815	736	668	609	558	513	474	439	408	380	355	332	312	293	276	260	246	233
1,50	q lim SLU	1311	1177	1064	967	882	809	745	688	638	593	553	517	484	454	427	403	380	360	341
	q lim (L/200)	1311	1177	1064	967	882	809	745	688	638	593	553	517	484	454	427	403	380	360	341
	q lim (L/250)	1311	1177	1064	967	882	809	745	688	638	593	553	517	484	454	427	403	380	360	341
	q lim (L/300)	1311	1177	1064	967	882	809	745	688	638	593	553	517	484	454	427	403	380	360	341
	q lim (L/350)	1311	1177	1064	967	882	809	745	688	638	593	553	517	484	454	427	397	358	323	293

LEGENDA / INDEX

Valori carico ammissibile uniformemente distribuito
Distributed load and resistance factor design

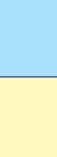

> Per la condizione di Stato Limite Ultimo (SLU) della lamiera / *Ultimate limit-state design of the corrugated sheet (SLU)*

> Per la condizione di Stato Limite di Esercizio (SLE) della lamiera ($F \leq L/200; L/250; L/300; L/350$) / *Serviceability limit of the corrugated sheet (SLE) ($F \leq L/200; L/250; L/300; L/350$)*

I rapporti di prova pubblicati in questo catalogo vengono forniti a titolo puramente indicativo. I dati pubblicati sono stati calcolati secondo le Norme vigenti: NTC2018, Circolare esplicativa alle NTC2018, UNI EN 1993 (EC3). Per una corretta applicazione del prodotto sarà onere e cura del cliente e/o del progettista la redazione di calcoli appropriati con specifico riferimento al singolo impiego.

The test reports published in this catalogue are provided for indicative purposes only. The published data have been calculated according to the current regulations: NTC2018, Explanatory circular to NTC2018, UNI EN 1993 (EC3). For a correct application of the product, it will be responsibility and care of the customer and/or the designer to draw up appropriate calculations with specific reference to the individual use.

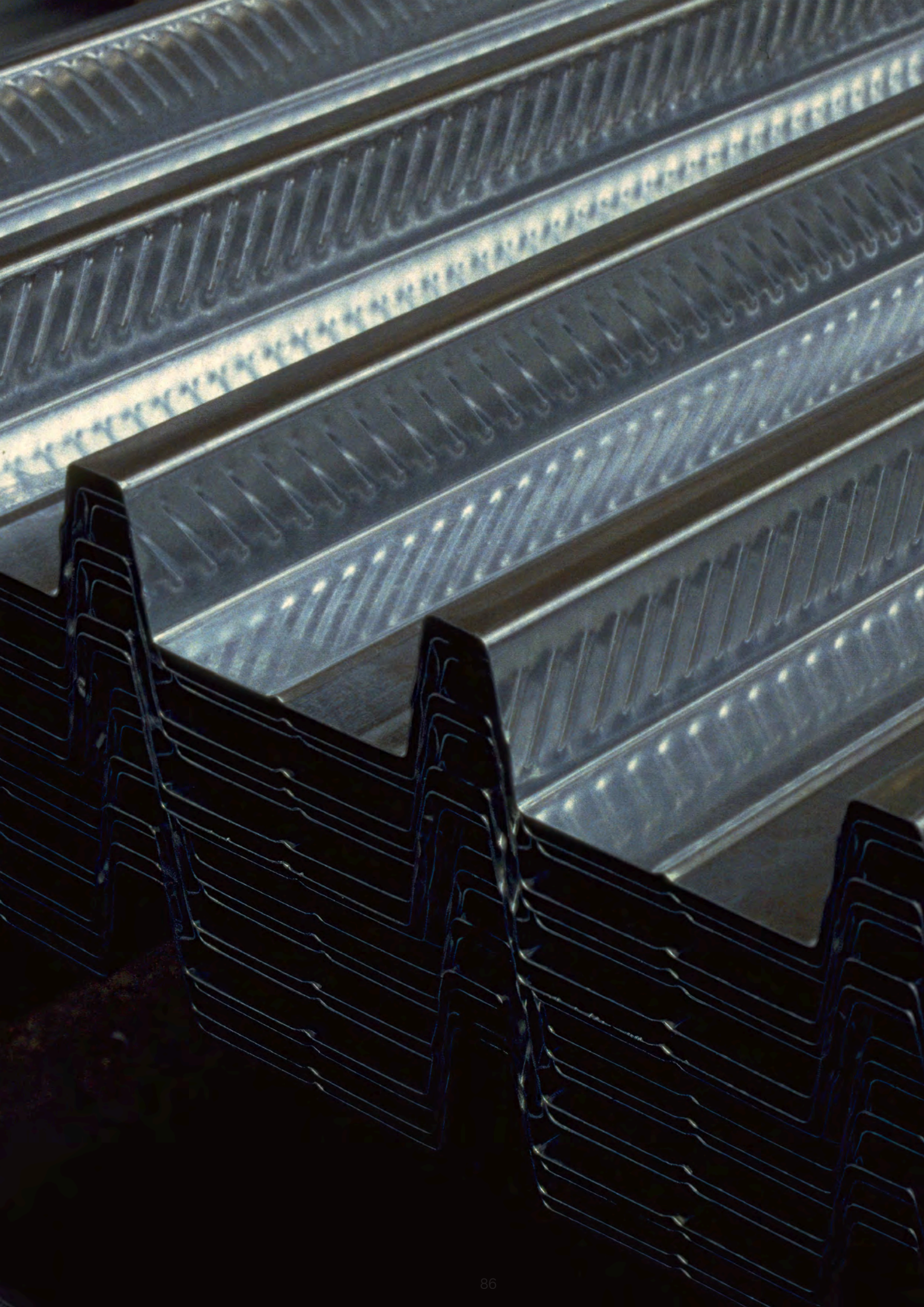

L'ampia gamma di elementi grecati Isolpack annovera anche la Serie AM: lamiere grecate per solai con getto in CLS. La serie AM si distingue per la particolare imbutitura sulla parte verticale delle greche, realizzata con impianti speciali, che conferisce ad una maggiore aderenza tra lastra metallica e getto in calcestruzzo. La conformazione aperta delle greche permette ai progettisti, che utilizzano programmi di calcolo, di inserire agevolmente tondini ad aderenza migliorata, reti elettrosaldate o applicare connettori a pioli "Nelson" per ottenere le performances desiderate dall'abbinamento lamiera grecata - calcestruzzo.

L'impiego delle Lamiere Grecate Isolpack Serie AM, rispetto ad altri solai prefabbricati, consente risparmi nei costi di trasporto e sollevamento, nonché tempi di realizzazione dell'opera molto ridotti, in quanto possono essere gettati, contemporaneamente, più solai anche a piani diversi.

The wide range of Isolpack corrugated elements also includes the AM Series: corrugated metal sheets for floors with concrete casting. The AM series stands out for the particular deep drawing on the vertical part of the ribs, made using a special production, which contributes to greater adherence between the metal plate and the concrete casting. The open conformation of the ribs allows designers, who use calculation programs, to easily insert rods with improved adhesion and easily apply an electro-welded mesh or welded shear connectors "Nelson" to obtain better adherence between corrugated metal sheet - concrete. The use of Isolpack AM Series corrugated metal sheets, compared to other prefabricated floors, allows savings in transport and lifting costs, as well as very short construction times, as multiple floors can be cast at the same time, even on different floors.



E/S 4000 AM / LAMIERE DA SOLAIO CLS AM - CONCRETE SLAB CORRUGATED SHEETS



CLASSE / CLASS

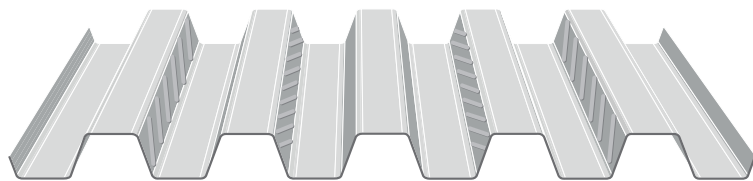

Lamiera ad aderenza migliorata, leggera, dai minimi ingombri e facile da montare. Presenta una greca più bassa, ideale per solai caratterizzati da spazi contenuti. E' disponibile anche nella versione per solai a secco.

Metal sheet with improved adhesion, light, with minimal dimensions and easy to assemble. It has a lower rib, ideal for floors characterized by limited spaces. It is also available in the version for dry floors.

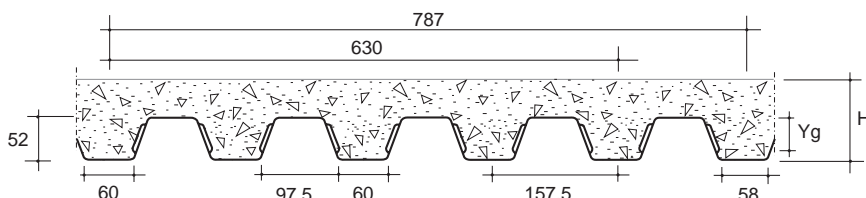

Caratteristiche tecniche - Datasheet

Dimensioni: larghezza 787 (mm), lunghezza a richiesta da produzione in continuo.

Spessori: fino a mm 1,5 - anche non standard su richiesta.

Supporti: acciaio zincato.

Alcune tipologie di acciaio, fornibili a richiesta previo accordo sui quantitativi minimi: S 235; S 250 GD+Z; S 260 NC; S 275; S 280 GD+Z; S 315 MC; S 315 NC; S 320 GD+Z (ed altri ancora).

Dimensions: width 787 (mm), length upon request from continuous production process.

Thicknesses (S): up to mm 1,5 - also non-standard on request.

Supports: galvanized steel.

Some types of steel supplied upon request previous agreement on minimum quantities: S 235; S 250 GD+Z; S 260 NC; S 275; S 280 GD+Z; S 315 MC; S 315 NC; S 320 GD+Z (and others more).

MODELLO LAMIERA GRECATA E/S 4000 AM - ACCIAIO S 250 GD+Z / STEEL S 250 GD+Z CARATTERISTICHE STATICHE / STATIC CHARACTERISTICS														
CONDIZIONI DI PROGETTO COME ESEMPIO: LAMIERA GRECATA E/S 4000 AM - LAMIERA A PERDERE - VERSO DI POSA: NORMALE - ACCIAIO S 250 GD - sp. 15/10 mm														
APPOGGIO INTERMEDIO: CLS S ₃ int 100 mm - APPOGGIO LATERALE: CLS S ₃ lat 100 mm - TIPOLOGIA CLS: C 25/30														
ARMATURA INFERIORE N° 1 AD OGNI GRECA - DISPOSIZIONE CONTINUA - φ 8 - Copriferro (mm): 15														
RETE ARMATURA SUPERIORE: φ 6 - INTERASSE RETE: i= 200 mm - Copriferro (mm): 20														
ARMATURA SUPERIORE INTEGRATIVA APPOGGI INTERMEDI: φ 8 - INTERASSE: i= 200 mm - Copriferro (mm): 30														
PROPRIETA' DI MASSA EFFICACI: - EFFECTIVE MASS PROPERTIES:														
CARATTERISTICHE DELLA SOLETTA SLAB CHARACTERISTICS														
			MOMENTO POSITIVO IN CAMPATA POSITIVE MOMENT ON SPAN						MOMENTO NEGATIVO SULL'APPOGGIO NEGATIVE MOMENT ON SUPPORT					
			J _h	W _{cls}	W _{alamsup}	W _{ainf}	W _{alaminf}	J _h	W _{asup1}	W _{asup2}	W _{alamsup}	W _{ainf}	W _{cls}	W _{alaminf}
mm	mm	Kg/m	cm ⁴ /m	cm ³ /m	cm ³ /m	cm ³ /m	cm ³ /m	cm ⁴ /m	cm ³ /m	cm ³ /m	cm ³ /m	cm ³ /m	cm ³ /m	
40	92,75	184,82	930,89	571,08	-380,74	-153,36	-121,77	687,52	134,00	166,44	224,99	-1207,72	-332,25	-320,63
50	102,75	210,31	1208,63	695,77	-362,09	-173,58	-141,56	944,76	158,51	190,47	327,44	-1277,16	-421,82	-408,15
60	112,75	235,79	1524,55	829,10	-359,89	-193,93	-161,56	1245,74	183,24	214,84	457,42	-1381,74	-518,72	-503,01
80	132,75	286,76	2271,73	1119,65	-375,74	-234,90	-202,00	1980,55	233,11	264,21	818,03	-1645,12	-732,48	-712,71
100	152,75	337,73	3173,84	1439,52	-403,27	-276,10	-242,83	2894,69	283,32	314,06	1351,47	-1951,76	-970,36	-946,56
120	172,75	388,70	4231,96	1786,33	-436,02	-317,45	-283,91	3990,34	333,75	364,21	2121,23	-2288,23	-1230,12	-1202,32

TABELLA DI PORTATA E/S 4000 AM: ACCIAIO S 250 GD / LOAD TABLE E/S 4000 AM: STEEL S 250 GD

PORTATA DEL PROFILO IN daN/m ² CON FRECCIA ≤ L/250 / SHEET CAPACITY, daN/m ² WITH DEFLECTION ≤ L/250 OF A SPAN																					
sp. lamiera thickness	sp. soletta slab height	sp. caldana concrete height	 Distanza tra gli appoggi "L" in metri / Pitch "L" in metres between the supports																		
			(mm)	(mm)	(mm)	1,5	1,75	2	2,5	2,75	3	3,25	3,5	3,75	4	4,25	4,5	4,75	5	5,25	5,5
0,8	92,5	40	2658	2146	1643	1051	869	730	622	536	467	411	364	325	291	263	238	217	199	183	
			2658	1769	1197	626	477	372	296	241	199	166	141	120	104	91	79	70	62	56	
	112,5	60	3096	2653	2317	1483	1225	1030	877	757	659	579	513	458	411	371	336	306	280	257	
			3096	2653	1948	1017	772	602	479	388	320	267	226	193	166	145	127	112	99	89	
	132,5	80	3740	3205	2805	1796	1484	1247	1063	916	798	702	621	554	498	449	407	371	340	312	
			3740	3205	2805	1509	1145	891	709	574	473	394	333	284	245	213	187	165	146	130	
	152,5	100	4154	3561	3116	2111	1745	1466	1249	1077	938	825	730	652	585	528	479	436	399	366	
			4154	3561	3116	2104	1596	1242	987	800	658	549	463	395	341	296	259	228	203	181	
	172,5	120	4549	3900	3412	2427	2006	1686	1436	1238	1079	948	840	749	672	607	550	501	459	421	
			4549	3900	3412	2427	2006	1654	1315	1065	876	730	617	526	453	394	345	304	270	240	
	1,0	92,5	40	2658	2146	1643	1051	869	730	622	536	467	411	364	325	291	263	238	217	199	183
				2658	1769	1197	626	476	372	296	241	199	166	141	120	104	90	79	70	62	56
112,5		60	3096	2653	2317	1483	1225	1030	877	757	659	579	513	458	411	371	336	306	280	257	
			3096	2653	1948	1017	772	601	479	388	320	267	226	193	166	145	127	112	99	89	
132,5		80	3740	3205	2805	1796	1484	1247	1063	916	798	702	621	554	498	449	407	371	340	312	
			3740	3205	2805	1508	1145	891	709	574	473	394	333	284	245	213	186	164	146	130	
152,5		100	4154	3561	3116	2111	1745	1466	1249	1077	938	825	730	652	585	528	479	436	399	366	
			4154	3561	3116	2103	1596	1242	987	800	658	549	463	395	340	296	259	228	203	181	
172,5		120	4549	3900	3412	2427	2006	1686	1436	1238	1079	948	840	749	672	607	550	501	459	421	
			4549	3900	3412	2427	2006	1654	1315	1065	876	730	616	526	453	394	345	304	269	240	
1,2		92,5	40	2645	2146	1643	1051	869	730	622	536	467	411	364	325	291	263	238	217	199	183
				2645	1769	1196	626	476	372	296	241	198	166	140	120	104	90	79	70	62	56
	112,5	60	3086	2645	2314	1483	1225	1030	877	757	659	579	513	458	411	371	336	306	280	257	
			3086	2645	1947	1016	772	601	479	388	319	267	225	193	166	144	127	112	99	89	
	132,5	80	3728	3195	2796	1796	1484	1247	1063	916	798	702	621	554	498	449	407	371	340	312	
			3728	3195	2796	1508	1144	891	709	574	472	394	333	284	245	213	186	164	146	130	
	152,5	100	4141	3550	3106	2111	1745	1466	1249	1077	938	825	730	652	585	528	479	436	399	366	
			4141	3550	3106	2103	1595	1241	987	799	658	548	463	395	340	296	259	228	202	181	
	172,5	120	4535	3887	3401	2427	2006	1686	1436	1238	1079	948	840	749	672	607	550	501	459	421	
			4535	3887	3401	2427	2006	1654	1314	1064	875	730	616	526	453	393	344	304	269	240	
	1,25	92,5	40	2642	2146	1643	1051	869	730	622	536	467	411	364	325	291	263	238	217	199	183
				2642	1769	1196	626	476	372	296	240	198	166	140	120	104	90	79	70	62	56
112,5		60	3083	2643	2313	1483	1225	1030	877	757	659	579	513	458	411	371	336	306	280	257	
			3083	2643	1947	1016	772	601	478	388	319	267	225	193	166	144	127	112	99	89	
132,5		80	3725	3193	2794	1796	1484	1247	1063	916	798	702	621	554	498	449	407	371	340	312	
			3725	3193	2794	1508	1144	891	708	574	472	394	333	284	245	213	186	164	146	130	
152,5		100	4138	3547	3103	2111	1745	1466	1249	1077	938	825	730	652	585	528	479	436	399	366	
			4138	3547	3103	2103	1595	1241	987	799	657	548	463	395	340	296	259	228	202	181	
172,5		120	4531	3884	3399	2427	2006	1686	1436	1238	1079	948	840	749	672	607	550	501	459	421	
			4531	3884	3399	2427	2006	1653	1314	1064	875	730	616	526	453	393	344	303	269	240	
1,5		92,5	40	2626	2146	1643	1051	869	730	622	536	467	411	364	325	291	263	238	217	199	183
				2626	1768	1196	626	476	371	296	240	198	166	140	120	104	90	79	70	62	56
	112,5	60	3071	2632	2303	1483	1225	1030	877	757	659	579	513	458	411	371	336	306	280	257	
			3071	2632	1947	1016	771	601	478	388	319	267	225	192	166	144	126	112	99	89	
	132,5	80	3710	3180	2782	1796	1484	1247	1063	916	798	702	621	554	498	449	407	371	340	312	
			3710	3180	2782	1507	1144	890	708	574	472	394	333	284	245	213	186	164	146	130	
	152,5	100	4122	3533	3091	2111	1745	1466	1249	1077	938	825	730	652	585	528	479	436	399	366	
			4122	3533	3091	2102	1595	1241	987	799	657	548	463	395	340	295	259	228	202	180	
	172,5	120	4513	3869	3385	2427	2006	1686	1436	1238	1079	948	840	749	672	607	550	501	459	421	
			4513	3869	3385	2427	2006	1653	1314	1064	875	730	616	525	452	393	344	303	269	240	

LEGENDA

- Per la condizione di Stato Limite Ultimo (SLU) della soletta / *Ultimate limit-state design of the concrete slab (SLU)*
- Per la condizione di Stato Limite di Esercizio (SLE) della soletta ($F \leq L/250$) / *Serviceability limit of the concrete slab (SLE) ($F \leq L/250$)*

I rapporti di prova pubblicati in questo catalogo vengono forniti a titolo puramente indicativo. I dati pubblicati sono stati calcolati secondo le Norme vigenti: NTC2018, Circolare esplicativa alle NTC2018, UNI EN 1993 (EC3). Per una corretta applicazione del prodotto sarà onere e cura del cliente e/o del progettista la redazione di calcoli appropriati con specifico riferimento al singolo impiego.

The test reports published in this catalogue are provided for indicative purposes only. The published data have been calculated according to the current regulations: NTC2018, Explanatory circular to NTC2018, UNI EN 1993 (EC3). For a correct application of the product, it will be responsibility and care of the customer and/or the designer to draw up appropriate calculations with specific reference to the individual use.

TABELLA DI PORTATA E/S 4000 AM: ACCIAIO S 250 GD / LOAD TABLE E/S 4000 AM: STEEL S 250 GD

PORTATA DEL PROFILO IN daN/m ² CON FRECCIA ≤ L/250 / SHEET CAPACITY, daN /m ² WITH DEFLECTION ≤ L/250 OF A SPAN																				
sp. lamiera thickness (mm)	sp. soletta slab height (mm)	sp. caldara concrete height (mm)	 Distanza tra gli appoggi "L" in metri / Pitch "L" in metres between the supports																	
			1,5	1,75	2	2,5	2,75	3	3,25	3,5	3,75	4	4,25	4,5	4,75	5	5,25	5,5	5,75	6
0,8	92,5	40	1893	1390	1065	681	563	473	403	348	303	266	236	210	189	170	154	141	129	118
			1893	1390	1065	681	563	473	403	348	303	266	236	210	189	170	154	141	129	118
	112,5	60	2603	2171	1662	1064	879	739	629	543	473	415	368	328	295	266	241	220	201	185
			2603	2171	1662	1064	879	739	629	543	473	415	368	328	295	266	241	220	201	185
	132,5	80	2994	2566	2245	1502	1241	1043	889	766	668	587	520	464	416	375	341	310	284	261
			2994	2566	2245	1502	1241	1043	889	766	668	587	520	464	416	375	341	310	284	261
	152,5	100	3361	2881	2521	1990	1644	1382	1177	1015	884	777	688	614	551	497	451	411	376	345
			3361	2881	2521	1990	1644	1382	1177	1015	884	777	688	614	551	497	451	411	376	345
	172,5	120	3709	3179	2782	2225	2023	1752	1492	1287	1121	985	873	778	699	631	572	521	477	438
			3709	3179	2782	2225	2023	1752	1492	1287	1121	985	873	778	699	631	572	521	477	438
1,0	92,5	40	1893	1390	1065	681	563	473	403	348	303	266	236	210	189	170	154	141	129	118
			1893	1390	1065	681	563	473	403	348	303	266	236	210	189	170	154	141	129	118
	112,5	60	2603	2171	1662	1064	879	739	629	543	473	415	368	328	295	266	241	220	201	185
			2603	2171	1662	1064	879	739	629	543	473	415	368	328	295	266	241	220	201	185
	132,5	80	2994	2566	2245	1502	1241	1043	889	766	668	587	520	464	416	375	341	310	284	261
			2994	2566	2245	1502	1241	1043	889	766	668	587	520	464	416	375	341	310	284	261
	152,5	100	3361	2881	2521	1990	1644	1382	1177	1015	884	777	688	614	551	497	451	411	376	345
			3361	2881	2521	1990	1644	1382	1177	1015	884	777	688	614	551	497	451	411	376	345
	172,5	120	3709	3179	2782	2225	2023	1752	1492	1287	1121	985	873	778	699	631	572	521	477	438
			3709	3179	2782	2225	2023	1752	1492	1287	1121	985	873	778	699	631	572	521	477	438
1,2	92,5	40	1891	1389	1064	681	563	473	403	347	303	266	236	210	189	170	154	141	129	118
			1891	1389	1064	681	563	473	403	347	303	266	236	210	189	170	154	141	129	118
	112,5	60	2595	2169	1660	1063	878	738	629	542	472	415	368	328	294	266	241	220	201	184
			2595	2169	1660	1063	878	738	629	542	472	415	368	328	294	266	241	220	201	184
	132,5	80	2985	2558	2238	1501	1240	1042	888	766	667	586	519	463	416	375	340	310	284	261
			2985	2558	2238	1501	1240	1042	888	766	667	586	519	463	416	375	340	310	284	261
	152,5	100	3350	2872	2513	1988	1643	1380	1176	1014	883	776	688	614	551	497	451	411	376	345
			3350	2872	2513	1988	1643	1380	1176	1014	883	776	688	614	551	497	451	411	376	345
	172,5	120	3697	3169	2773	2218	2017	1750	1491	1286	1120	984	872	778	698	630	571	521	476	437
			3697	3169	2773	2218	2017	1750	1491	1286	1120	984	872	778	698	630	571	521	476	437
1,25	92,5	40	1890	1389	1063	681	562	473	403	347	302	266	235	210	189	170	154	141	129	118
			1890	1389	1063	681	562	473	403	347	302	266	235	210	189	170	154	141	129	118
	112,5	60	2593	2168	1660	1062	878	738	629	542	472	415	368	328	294	266	241	220	201	184
			2593	2168	1660	1062	878	738	629	542	472	415	368	328	294	266	241	220	201	184
	132,5	80	2982	2556	2237	1500	1240	1042	888	765	667	586	519	463	416	375	340	310	284	260
			2982	2556	2237	1500	1240	1042	888	765	667	586	519	463	416	375	340	310	284	260
	152,5	100	3348	2869	2511	1987	1642	1380	1176	1014	883	776	688	613	551	497	451	411	376	345
			3348	2869	2511	1987	1642	1380	1176	1014	883	776	688	613	551	497	451	411	376	345
	172,5	120	3694	3167	2771	2217	2015	1750	1491	1285	1120	984	872	778	698	630	571	521	476	437
			3694	3167	2771	2217	2015	1750	1491	1285	1120	984	872	778	698	630	571	521	476	437
1,5	92,5	40	1888	1387	1062	680	562	472	402	347	302	265	235	210	188	170	154	140	128	118
			1888	1387	1062	680	562	472	402	347	302	265	235	210	188	170	154	140	128	118
	112,5	60	2582	2166	1658	1061	877	737	628	541	472	414	367	328	294	265	241	219	201	184
			2582	2166	1658	1061	877	737	628	541	472	414	367	328	294	265	241	219	201	184
	132,5	80	2970	2546	2228	1498	1238	1041	887	764	666	585	518	462	415	375	340	310	283	260
			2970	2546	2228	1498	1238	1041	887	764	666	585	518	462	415	375	340	310	283	260
	152,5	100	3334	2858	2501	1985	1640	1378	1175	1013	882	775	687	613	550	496	450	410	375	345
			3334	2858	2501	1985	1640	1378	1175	1013	882	775	687	613	550	496	450	410	375	345
	172,5	120	3680	3154	2760	2208	2007	1747	1489	1284	1118	983	871	777	697	629	571	520	476	437
			3680	3154	2760	2208	2007	1747	1489	1284	1118	983	871	777	697	629	571	520	476	437

LEGENDA

Per la condizione di Stato Limite Ultimo (SLU) della soletta / *Ultimate limit-state design of the concrete slab (SLU)*

Per la condizione di Stato Limite di Esercizio (SLE) della soletta ($F \leq L/250$) / *Serviceability limit of the concrete slab (SLE) ($F \leq L/250$)*

I rapporti di prova pubblicati in questo catalogo vengono forniti a titolo puramente indicativo. I dati pubblicati sono stati calcolati secondo le Norme vigenti: NTC2018, Circolare esplicativa alle NTC2018, UNI EN 1993 (EC3). Per una corretta applicazione del prodotto sarà onere e cura del cliente e/o del progettista la redazione di calcoli appropriati con specifico riferimento al singolo impiego.

The test reports published in this catalogue are provided for indicative purposes only. The published data have been calculated according to the current regulations: NTC2018, Explanatory circular to NTC2018, UNI EN 1993 (EC3). For a correct application of the product, it will be responsibility and care of the customer and/or the designer to draw up appropriate calculations with specific reference to the individual use.

TABELLA DI PORTATA E/S 4000 AM: ACCIAIO S 250 GD / LOAD TABLE E/S 4000 AM: STEEL S 250 GD

PORTATA DEL PROFILO IN daN/m ² CON FRECCIA ≤ L/250 / SHEET CAPACITY, daN/m ² WITH DEFLECTION ≤ L/250 OF A SPAN																					
sp. lamiera thickness	sp. soletta slab height	sp. caldana concrete height	 Distanza tra gli appoggi "L" in metri / Pitch "L" in metres between the supports																		
(mm)	(mm)	(mm)	1,5	1,75	2	2,5	2,75	3	3,25	3,5	3,75	4	4,25	4,5	4,75	5	5,25	5,5	5,75	6	
0,8	92,5	40	2271	1738	1331	852	704	591	504	435	379	333	295	263	236	213	193	176	161	148	
			2271	1738	1331	852	704	591	504	435	366	305	257	219	189	164	143	126	112	100	
	112,5	60	2711	2324	2034	1330	1099	923	787	678	591	519	460	410	368	332	301	275	251	231	
			2711	2324	2034	1330	1099	923	787	678	591	492	415	353	303	263	230	202	179	159	
	132,5	80	3119	2673	2339	1871	1552	1304	1111	958	834	733	650	579	520	469	426	388	355	326	
			3119	2673	2339	1871	1552	1304	1111	958	834	729	613	522	448	388	339	298	264	235	
	152,5	100	3501	3001	2626	2101	1910	1727	1472	1269	1105	972	861	768	689	622	564	514	470	432	
			3501	3001	2626	2101	1910	1727	1472	1269	1105	972	854	726	624	540	471	414	367	326	
	172,5	120	3863	3312	2898	2318	2107	1932	1783	1609	1401	1232	1091	973	873	788	715	651	596	547	
			3863	3312	2898	2318	2107	1932	1783	1609	1401	1232	1091	967	830	719	627	551	488	434	
	1,0	92,5	40	2271	1738	1331	852	704	591	504	435	379	333	295	263	236	213	193	176	161	148
				2271	1738	1331	852	704	591	504	435	366	305	257	219	188	164	143	126	112	100
112,5		60	2711	2324	2034	1330	1099	923	787	678	591	519	460	410	368	332	301	275	251	231	
			2711	2324	2034	1330	1099	923	787	678	591	492	414	353	303	263	230	202	179	159	
132,5		80	3119	2673	2339	1871	1552	1304	1111	958	834	733	650	579	520	469	426	388	355	326	
			3119	2673	2339	1871	1552	1304	1111	958	834	728	613	522	448	388	339	298	264	235	
152,5		100	3501	3001	2626	2101	1910	1727	1472	1269	1105	972	861	768	689	622	564	514	470	432	
			3501	3001	2626	2101	1910	1727	1472	1269	1105	972	854	726	624	540	471	414	366	326	
172,5		120	3863	3312	2898	2318	2107	1932	1783	1609	1401	1232	1091	973	873	788	715	651	596	547	
			3863	3312	2898	2318	2107	1932	1783	1609	1401	1232	1091	967	830	719	627	551	488	434	
1,2		92,5	40	2263	1736	1329	851	703	591	503	434	378	332	294	263	236	213	193	176	161	148
				2263	1736	1329	851	703	591	503	434	365	304	257	219	188	163	143	126	112	100
	112,5	60	2703	2317	2027	1328	1098	922	786	678	590	519	460	410	368	332	301	274	251	231	
			2703	2317	2027	1328	1098	922	786	678	590	492	414	353	303	263	229	202	179	159	
	132,5	80	3109	2665	2332	1865	1550	1303	1110	957	834	733	649	579	520	469	425	388	355	326	
			3109	2665	2332	1865	1550	1303	1110	957	834	728	613	521	448	388	339	298	263	234	
	152,5	100	3490	2991	2617	2094	1904	1726	1470	1268	1104	971	860	767	688	621	563	513	470	431	
			3490	2991	2617	2094	1904	1726	1470	1268	1104	971	854	726	623	540	471	414	366	326	
	172,5	120	3851	3301	2888	2311	2101	1926	1777	1607	1400	1230	1090	972	873	787	714	651	595	547	
			3851	3301	2888	2311	2101	1926	1777	1607	1400	1230	1090	966	830	718	627	551	487	433	
	1,25	92,5	40	2262	1736	1329	851	703	591	503	434	378	332	294	263	236	213	193	176	161	148
				2262	1736	1329	851	703	591	503	434	365	304	257	219	188	163	143	126	112	99
112,5		60	2701	2315	2025	1328	1098	922	786	678	590	519	460	410	368	332	301	274	251	231	
			2701	2315	2025	1328	1098	922	786	678	590	492	414	353	303	263	229	202	179	159	
132,5		80	3106	2663	2330	1864	1550	1302	1110	957	833	732	649	579	519	469	425	387	354	326	
			3106	2663	2330	1864	1550	1302	1110	957	833	728	613	521	448	388	339	298	263	234	
152,5		100	3487	2989	2615	2092	1902	1725	1470	1267	1104	970	860	767	688	621	563	513	470	431	
			3487	2989	2615	2092	1902	1725	1470	1267	1104	970	853	726	623	540	471	414	366	326	
172,5		120	3848	3298	2886	2309	2099	1924	1776	1607	1400	1230	1090	972	872	787	714	651	595	547	
			3848	3298	2886	2309	2099	1924	1776	1607	1400	1230	1090	966	830	718	627	551	487	433	
1,5		92,5	40	2253	1734	1327	850	702	590	503	433	378	332	294	262	235	212	193	176	161	147
				2253	1734	1327	850	702	590	503	433	365	304	257	219	188	163	143	126	111	99
	112,5	60	2690	2306	2017	1326	1096	921	785	677	590	518	459	409	367	332	301	274	251	230	
			2690	2306	2017	1326	1096	921	785	677	590	491	414	352	303	262	229	202	178	159	
	132,5	80	3094	2652	2321	1856	1548	1301	1108	956	832	732	648	578	519	468	425	387	354	325	
			3094	2652	2321	1856	1548	1301	1108	956	832	728	613	521	447	388	338	297	263	234	
	152,5	100	3473	2977	2605	2084	1895	1723	1468	1266	1103	969	859	766	687	620	563	513	469	431	
			3473	2977	2605	2084	1895	1723	1468	1266	1103	969	853	725	623	539	471	414	366	326	
	172,5	120	3833	3285	2875	2300	2091	1916	1769	1605	1398	1229	1088	971	871	786	713	650	595	546	
			3833	3285	2875	2300	2091	1916	1769	1605	1398	1229	1088	966	829	718	627	551	487	433	

LEGENDA

Per la condizione di Stato Limite Ultimo (SLU) della soletta / *Ultimate limit-state design of the concrete slab (SLU)*

Per la condizione di Stato Limite di Esercizio (SLE) della soletta ($F \leq L/250$) / *Serviceability limit of the concrete slab (SLE) ($F \leq L/250$)*

I rapporti di prova pubblicati in questo catalogo vengono forniti a titolo puramente indicativo. I dati pubblicati sono stati calcolati secondo le Norme vigenti: NTC2018, Circolare esplicativa alle NTC2018, UNI EN 1993 (EC3). Per una corretta applicazione del prodotto sarà onere e cura del cliente e/o del progettista la redazione di calcoli appropriati con specifico riferimento al singolo impiego.

The test reports published in this catalogue are provided for indicative purposes only. The published data have been calculated according to the current regulations: NTC2018, Explanatory circular to NTC2018, UNI EN 1993 (EC3). For a correct application of the product, it will be responsibility and care of the customer and/or the designer to draw up appropriate calculations with specific reference to the individual use.

S/C 2000 AM / LAMIERE DA SOLAIO CLS AM - CONCRETE SLAB CORRUGATED SHEETS



CLASSE / CLASS

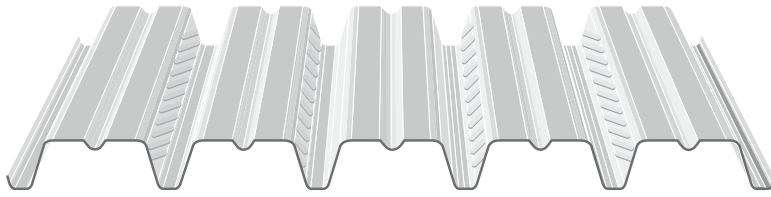

Lamiera studiata per fornire una migliore aderenza tra supporto metallico e calcestruzzo, è ideale per solai collaboranti. Disponibile anche nella versione Deck per solai a secco.

Metal sheet designed to provide better adhesion between the metal support and the concrete, it is ideal for collaborating floors. Also available in the Deck version for dry floors.

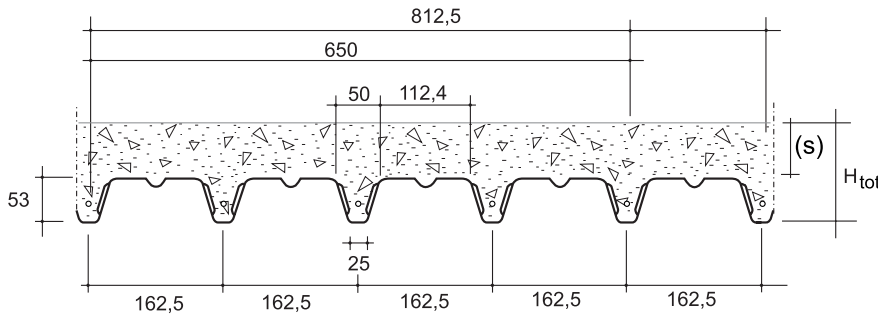

Caratteristiche tecniche - Datasheet

Dimensioni: larghezza 812,5 (mm), lunghezza a richiesta da produzione in continuo.

Spessori: fino a mm 1,5 - anche non standard su richiesta.

Supporti: acciaio zincato.

Alcune tipologie di acciaio, fornibili a richiesta previo accordo sui quantitativi minimi: S 235; S 250 GD+Z; S 260 NC; S 275; S 280 GD+Z; S 315 MC; S 315 NC; S 320 GD+Z (ed altri ancora).

Dimensions: width 812,5 (mm), length upon request from continuous production process.

Thicknesses (S): up to mm 1,5 - also non-standard on request.

Supports: galvanized steel.

Some types of steel supplied upon request previous agreement on minimum quantities: S 235; S 250 GD+Z; S 260 NC; S 275; S 280 GD+Z; S 315 MC; S 315 NC; S 320 GD+Z (and others more).

MODELLO LAMIERA GRECATA S/C 2000 AM - ACCIAIO S 250 GD+Z / STEEL S 250 GD+Z CARATTERISTICHE STATICHE / STATIC CHARACTERISTICS														
CONDIZIONI DI PROGETTO COME ESEMPIO: LAMIERA GRECATA S/C 2000 AM - LAMIERA A PERDERE - VERSO DI POSA: NORMALE - ACCIAIO S 250 GD - sp. 15/10 mm														
APPOGGIO INTERMEDIO: CLS S_s int 100 mm - APPOGGIO LATERALE: CLS S_s lat 100 mm - TIPOLOGIA CLS: C 25/30														
ARMATURA INFERIORE N° 1 AD OGNI GRECA - DISPOSIZIONE CONTINUA - ϕ 8 - Copriferro (mm): 15														
RETE ARMATURA SUPERIORE: ϕ 6 - INTERASSE RETE: $i=200$ mm - Copriferro (mm): 20														
ARMATURA SUPERIORE INTEGRATIVA APPOGGI INTERMEDI: ϕ 8 - INTERASSE: $i=200$ mm - Copriferro (mm): 30														
CARATTERISTICHE DELLA SOLETTA SLAB CHARACTERISTICS		PROPRIETA' DI MASSA EFFICACI - EFFECTIVE MASS PROPERTIES:												
		MOMENTO POSITIVO IN CAMPATA POSITIVE MOMENT ON SPAN						MOMENTO NEGATIVO SULL'APPOGGIO NEGATIVE MOMENT ON SUPPORT						
Altezza caldana (s) Concrete slab height	Altezza soletta (H_{tot}) Total slab height	Peso soletta (P) Slab Weight	J_n	W_{cis}	$W_{alamsup}$	W_{ainf}	$W_{alaminf}$	J_n	W_{asup1}	W_{asup2}	$W_{alamsup}$	W_{ainf}	W_{cis}	$W_{alaminf}$
mm	mm	Kg/m	cm ⁴ /m	cm ³ /m	cm ³ /m	cm ³ /m	cm ³ /m	cm ⁴ /m	cm ³ /m	cm ³ /m	cm ³ /m	cm ³ /m	cm ³ /m	cm ³ /m
40	94,25	150,42	944,81	581,24	-385,71	-151,79	-121,14	602,80	129,54	164,99	233,78	-503,79	-223,55	-217,50
50	104,25	175,91	1220,44	705,50	-364,84	-171,41	-140,36	833,18	153,91	188,78	356,29	-579,99	-283,73	-276,66
60	114,25	201,39	1533,18	838,18	-361,10	-191,15	-159,78	1103,71	178,47	212,89	523,24	-662,64	-348,65	-340,58
80	134,25	252,36	2270,75	1126,92	-374,71	-230,88	-199,01	1767,30	227,93	261,68	1052,80	-843,04	-491,42	-481,38
100	154,25	303,33	3158,81	1444,35	-400,46	-270,84	-238,62	2597,15	277,67	310,92	2031,83	-1040,20	-649,81	-637,84
120	174,25	354,30	4198,38	1788,17	-431,61	-310,94	-278,46	3596,12	327,59	360,42	3984,80	-1251,90	-822,43	-808,56

TABELLA DI PORTATA S/C 2000 AM: ACCIAIO S 250 GD / LOAD TABLE S/C 2000 AM: STEEL S 250 GD

PORTATA DEL PROFILO IN daN/m ² CON FRECCIA ≤ L/250 / SHEET CAPACITY, daN/m ² WITH DEFLECTION ≤ L/250 OF A SPAN																					
sp. lamiera thickness	sp. soletta slab height	sp. caldana concrete height	 Distanza tra gli appoggi "L" in metri / Pitch "L" in metres between the supports																		
			1,5	1,75	2	2,5	2,75	3	3,25	3,5	3,75	4	4,25	4,5	4,75	5	5,25	5,5	5,75	6	
0,8	94,2	40	1055	904	791	633	575	528	487	452	422	396	370	330	296	268	243	221	202	186	
			1055	904	791	609	460	356	281	226	185	154	129	109	94	81	70	62	54	48	
	114,2	60	1296	1111	972	777	707	648	598	555	518	486	457	432	405	365	331	302	276	254	
			1296	1111	972	777	707	576	455	367	300	248	208	177	151	130	114	99	88	78	
	134,2	80	2002	1716	1501	1201	1092	1001	924	858	785	690	611	545	489	441	400	365	334	306	
			2002	1716	1501	1201	1092	854	675	544	444	368	309	262	224	194	169	148	130	116	
	154,2	100	2221	1904	1666	1333	1211	1110	1025	952	888	809	717	639	574	518	470	428	391	360	
			2221	1904	1666	1333	1211	1110	942	758	620	514	432	366	314	271	236	207	182	162	
	174,2	120	2430	2083	1822	1458	1325	1215	1121	1041	972	911	823	734	659	594	539	491	449	413	
			2430	2083	1822	1458	1325	1215	1121	1011	827	686	576	489	419	362	315	277	244	217	
	1,0	94,2	40	1041	892	781	625	568	521	481	446	416	390	367	330	296	268	243	221	202	186
				1041	892	781	609	459	356	281	226	185	153	129	109	93	81	70	62	54	48
114,2		60	1279	1096	959	767	698	639	590	548	512	480	451	426	404	365	331	302	276	254	
			1279	1096	959	767	698	576	455	366	299	248	208	176	151	130	113	99	88	78	
134,2		80	1984	1701	1488	1190	1082	992	916	850	785	690	611	545	489	441	400	365	334	306	
			1984	1701	1488	1190	1082	854	675	543	444	368	309	262	224	194	168	148	130	115	
154,2		100	2201	1887	1651	1321	1201	1101	1016	943	881	809	717	639	574	518	470	428	391	360	
			2201	1887	1651	1321	1201	1101	941	758	620	514	431	366	313	271	236	206	182	162	
174,2		120	2408	2064	1806	1445	1314	1204	1112	1032	963	903	823	734	659	594	539	491	449	413	
			2408	2064	1806	1445	1314	1204	1112	1011	827	686	576	489	419	362	315	276	244	217	
1,2		94,2	40	1027	881	770	616	560	514	474	440	411	385	363	330	296	268	243	221	202	186
				1027	881	770	608	459	355	281	226	185	153	129	109	93	81	70	61	54	48
	114,2	60	1262	1081	946	757	688	631	582	541	505	473	445	421	398	365	331	302	276	254	
			1262	1081	946	757	688	576	455	366	299	248	208	176	151	130	113	99	87	78	
	134,2	80	1966	1685	1475	1180	1073	983	908	843	785	690	611	545	489	441	400	365	334	306	
			1966	1685	1475	1180	1073	854	675	543	444	368	309	262	224	193	168	147	130	115	
	154,2	100	2182	1870	1636	1309	1190	1091	1007	935	873	809	717	639	574	518	470	428	391	360	
			2182	1870	1636	1309	1190	1091	941	758	620	514	431	366	313	270	235	206	182	161	
	174,2	120	2387	2046	1790	1432	1302	1194	1102	1023	955	895	823	734	659	594	539	491	449	413	
			2387	2046	1790	1432	1302	1194	1102	1010	827	686	576	489	419	362	315	276	244	216	
	1,25	94,2	40	1024	878	768	614	558	512	473	439	410	384	361	330	296	268	243	221	202	186
				1024	878	768	608	459	355	281	226	185	153	129	109	93	81	70	61	54	48
114,2		60	1257	1078	943	754	686	629	580	539	503	472	444	419	397	365	331	302	276	254	
			1257	1078	943	754	686	576	455	366	299	248	208	176	151	130	113	99	87	78	
134,2		80	1962	1682	1471	1177	1070	981	905	841	785	690	611	545	489	441	400	365	334	306	
			1962	1682	1471	1177	1070	854	675	543	444	368	309	262	224	193	168	147	130	115	
154,2		100	2177	1866	1633	1306	1187	1088	1005	933	871	809	717	639	574	518	470	428	391	360	
			2177	1866	1633	1306	1187	1088	941	758	620	514	431	366	313	270	235	206	182	161	
174,2		120	2382	2041	1786	1429	1299	1191	1099	1021	953	893	823	734	659	594	539	491	449	413	
			2382	2041	1786	1429	1299	1191	1099	1010	827	686	576	488	418	362	315	276	244	216	
1,5		94,2	40	1006	863	755	604	549	503	465	431	403	377	355	330	296	268	243	221	202	186
				1006	863	755	604	459	355	281	226	185	153	128	109	93	80	70	61	54	48
	114,2	60	1236	1060	927	742	674	618	571	530	494	464	436	412	390	365	331	302	276	254	
			1236	1060	927	742	674	575	455	366	299	248	208	176	151	130	113	99	87	77	
	134,2	80	1940	1663	1455	1164	1058	970	895	831	776	690	611	545	489	441	400	365	334	306	
			1940	1663	1455	1164	1058	853	674	543	444	368	308	261	224	193	168	147	130	115	
	154,2	100	2152	1845	1614	1291	1174	1076	993	922	861	807	717	639	574	518	470	428	391	360	
			2152	1845	1614	1291	1174	1076	940	757	619	513	431	365	313	270	235	206	182	161	
	174,2	120	2355	2018	1766	1413	1284	1177	1087	1009	942	883	823	734	659	594	539	491	449	413	
			2355	2018	1766	1413	1284	1177	1087	1009	826	685	575	488	418	361	315	276	243	216	

LEGENDA

Per la condizione di Stato Limite Ultimo (SLU) della soletta / *Ultimate limit-state design of the concrete slab (SLU)*

Per la condizione di Stato Limite di Esercizio (SLE) della soletta ($F \leq L/250$) / *Serviceability limit of the concrete slab (SLE) ($F \leq L/250$)*

I rapporti di prova pubblicati in questo catalogo vengono forniti a titolo puramente indicativo. I dati pubblicati sono stati calcolati secondo le Norme vigenti: NTC2018, Circolare esplicativa alle NTC2018, UNI EN 1993 (EC3). Per una corretta applicazione del prodotto sarà onere e cura del cliente e/o del progettista la redazione di calcoli appropriati con specifico riferimento al singolo impiego.

The test reports published in this catalogue are provided for indicative purposes only. The published data have been calculated according to the current regulations: NTC2018, Explanatory circular to NTC2018, UNI EN 1993 (EC3). For a correct application of the product, it will be responsibility and care of the customer and/or the designer to draw up appropriate calculations with specific reference to the individual use.

TABELLA DI PORTATA S/C 2000 AM: ACCIAIO S 250 GD / LOAD TABLE S/C 2000 AM: STEEL S 250 GD

PORTATA DEL PROFILO IN daN/m ² CON FRECCIA ≤ L/250 / SHEET CAPACITY, daN/m ² WITH DEFLECTION ≤ L/250 OF A SPAN																					
sp. lamiera thickness	sp. soletta slab height	sp. caldara concrete height	 Distanza tra gli appoggi "L" in metri / Pitch "L" in metres between the supports																		
			1,5	1,75	2	2,5	2,75	3	3,25	3,5	3,75	4	4,25	4,5	4,75	5	5,25	5,5	5,75	6	
0,8	94,2	40	942	807	706	464	384	323	275	237	206	181	161	143	129	116	105	96	88	81	
			942	807	706	464	384	323	275	237	206	181	161	143	129	116	105	96	88	81	
	114,2	60	1222	1048	917	724	599	503	429	370	322	283	251	224	201	181	164	150	137	126	
			1222	1048	917	724	599	503	429	370	322	283	251	224	201	181	164	150	137	126	
	134,2	80	1503	1288	1127	902	820	709	604	521	454	399	353	315	283	255	231	211	193	177	
			1503	1288	1127	902	820	709	604	521	454	399	353	315	283	255	231	211	193	177	
	154,2	100	1783	1529	1338	1070	973	892	799	689	600	527	467	417	374	337	306	279	255	234	
			1783	1529	1338	1070	973	892	799	689	600	527	467	417	374	337	306	279	255	234	
	174,2	120	2003	1717	1502	1202	1092	1001	924	858	759	667	591	527	473	427	387	353	323	297	
			2003	1717	1502	1202	1092	1001	924	858	759	667	591	527	473	427	387	353	323	297	
	1,0	94,2	40	929	796	697	462	382	321	274	236	206	181	160	143	128	116	105	96	87	80
				929	796	697	462	382	321	274	236	206	181	160	143	128	116	105	96	87	80
114,2		60	1206	1034	905	721	596	501	427	368	320	282	250	223	200	180	164	149	136	125	
			1206	1034	905	721	596	501	427	368	320	282	250	223	200	180	164	149	136	125	
134,2		80	1483	1271	1112	890	809	706	601	519	452	397	352	314	282	254	230	210	192	176	
			1483	1271	1112	890	809	706	601	519	452	397	352	314	282	254	230	210	192	176	
154,2		100	1760	1509	1320	1056	960	880	795	686	597	525	465	415	372	336	305	278	254	233	
			1760	1509	1320	1056	960	880	795	686	597	525	465	415	372	336	305	278	254	233	
174,2		120	1985	1701	1489	1191	1083	993	916	851	756	664	589	525	471	425	386	351	322	295	
			1985	1701	1489	1191	1083	993	916	851	756	664	589	525	471	425	386	351	322	295	
1,2		94,2	40	917	786	688	460	380	320	272	235	205	180	159	142	128	115	104	95	87	80
				917	786	688	460	380	320	272	235	205	180	159	142	128	115	104	95	87	80
	114,2	60	1190	1020	893	714	593	499	425	366	319	280	248	222	199	179	163	148	136	125	
			1190	1020	893	714	593	499	425	366	319	280	248	222	199	179	163	148	136	125	
	134,2	80	1463	1254	1097	878	798	703	599	516	450	395	350	312	280	253	229	209	191	176	
			1463	1254	1097	878	798	703	599	516	450	395	350	312	280	253	229	209	191	176	
	154,2	100	1737	1488	1302	1042	947	868	792	683	595	523	463	413	371	335	303	276	253	232	
			1737	1488	1302	1042	947	868	792	683	595	523	463	413	371	335	303	276	253	232	
	174,2	120	1967	1686	1476	1180	1073	984	908	843	753	662	586	523	469	423	384	350	320	294	
			1967	1686	1476	1180	1073	984	908	843	753	662	586	523	469	423	384	350	320	294	
	1,25	94,2	40	914	783	685	460	380	319	272	235	204	180	159	142	127	115	104	95	87	80
				914	783	685	460	380	319	272	235	204	180	159	142	127	115	104	95	87	80
114,2		60	1186	1017	890	712	593	498	424	366	319	280	248	221	199	179	163	148	136	125	
			1186	1017	890	712	593	498	424	366	319	280	248	221	199	179	163	148	136	125	
134,2		80	1458	1250	1094	875	795	702	598	516	449	395	350	312	280	253	229	209	191	175	
			1458	1250	1094	875	795	702	598	516	449	395	350	312	280	253	229	209	191	175	
154,2		100	1731	1483	1298	1038	944	865	791	682	594	522	462	413	370	334	303	276	253	232	
			1731	1483	1298	1038	944	865	791	682	594	522	462	413	370	334	303	276	253	232	
174,2		120	1963	1683	1472	1178	1071	981	906	841	752	661	585	522	469	423	384	350	320	294	
			1963	1683	1472	1178	1071	981	906	841	752	661	585	522	469	423	384	350	320	294	
1,5		94,2	40	898	770	674	457	378	318	271	233	203	179	158	141	127	114	104	94	86	79
				898	770	674	457	378	318	271	233	203	179	158	141	127	114	104	94	86	79
	114,2	60	1166	999	874	700	589	495	422	364	317	279	247	220	198	178	162	147	135	124	
			1166	999	874	700	589	495	422	364	317	279	247	220	198	178	162	147	135	124	
	134,2	80	1434	1229	1075	860	782	698	595	513	447	393	348	310	278	251	228	208	190	175	
			1434	1229	1075	860	782	698	595	513	447	393	348	310	278	251	228	208	190	175	
	154,2	100	1701	1458	1276	1021	928	851	785	678	591	519	460	410	368	332	301	275	251	231	
			1701	1458	1276	1021	928	851	785	678	591	519	460	410	368	332	301	275	251	231	
	174,2	120	1941	1663	1456	1164	1059	970	896	832	748	657	582	519	466	421	381	348	318	292	
			1941	1663	1456	1164	1059	970	896	832	748	657	582	519	466	421	381	348	318	292	

LEGENDA

Per la condizione di Stato Limite Ultimo (SLU) della soletta / *Ultimate limit-state design of the concrete slab (SLU)*

Per la condizione di Stato Limite di Esercizio (SLE) della soletta ($F \leq L/250$) / *Serviceability limit of the concrete slab (SLE) ($F \leq L/250$)*

I rapporti di prova pubblicati in questo catalogo vengono forniti a titolo puramente indicativo. I dati pubblicati sono stati calcolati secondo le Norme vigenti: NTC2018, Circolare esplicativa alle NTC2018, UNI EN 1993 (EC3). Per una corretta applicazione del prodotto sarà onere e cura del cliente e/o del progettista la redazione di calcoli appropriati con specifico riferimento al singolo impiego.

The test reports published in this catalogue are provided for indicative purposes only. The published data have been calculated according to the current regulations: NTC2018, Explanatory circular to NTC2018, UNI EN 1993 (EC3). For a correct application of the product, it will be responsibility and care of the customer and/or the designer to draw up appropriate calculations with specific reference to the individual use.

TABELLA DI PORTATA S/C 2000 AM: ACCIAIO S 250 GD / LOAD TABLE S/C 2000 AM: STEEL S 250 GD

PORTATA DEL PROFILO IN daN/m ² CON FRECCIA ≤ L/250 / SHEET CAPACITY, daN/m ² WITH DEFLECTION ≤ L/250 OF A SPAN																					
sp. lamiera thickness	sp. soletta slab height	sp. caldana concrete height	 Distanza tra gli appoggi "L" in metri / Pitch "L" in metres between the supports																		
			1,5	1,75	2	2,5	2,75	3	3,25	3,5	3,75	4	4,25	4,5	4,75	5	5,25	5,5	5,75	6	
0,8	94,2	40	981	841	736	581	480	403	344	296	258	227	201	179	161	145	132	120	110	101	
			981	841	736	581	480	403	344	296	258	227	201	179	161	145	131	115	101	89	
	114,2	60	1273	1091	955	764	694	629	536	462	402	354	313	279	251	226	205	187	171	157	
			1273	1091	955	764	694	629	536	462	402	354	313	279	251	226	205	185	163	144	
	134,2	80	1565	1342	1174	939	854	783	723	651	567	498	441	394	353	319	289	264	241	222	
			1565	1342	1174	939	854	783	723	651	567	498	441	394	353	319	289	264	241	214	
	154,2	100	1858	1592	1393	1115	1013	929	857	796	743	659	584	521	467	422	383	349	319	293	
			1858	1592	1393	1115	1013	929	857	796	743	659	584	521	467	422	383	349	319	293	
	174,2	120	2086	1788	1565	1252	1138	1043	963	894	834	782	736	659	591	534	484	441	404	371	
			2086	1788	1565	1252	1138	1043	963	894	834	782	736	659	591	534	484	441	404	371	
	1,0	94,2	40	968	830	726	578	478	401	342	295	257	226	200	178	160	145	131	119	109	100
				968	830	726	578	478	401	342	295	257	226	200	178	160	145	131	114	101	89
114,2		60	1256	1077	942	754	685	626	533	460	401	352	312	278	250	225	204	186	170	156	
			1256	1077	942	754	685	626	533	460	401	352	312	278	250	225	204	185	163	144	
134,2		80	1545	1324	1159	927	843	772	713	648	565	496	440	392	352	318	288	262	240	221	
			1545	1324	1159	927	843	772	713	648	565	496	440	392	352	318	288	262	240	214	
154,2		100	1833	1571	1375	1100	1000	917	846	786	733	656	581	518	465	420	381	347	318	292	
			1833	1571	1375	1100	1000	917	846	786	733	656	581	518	465	420	381	347	318	292	
174,2		120	2068	1772	1551	1241	1128	1034	954	886	827	775	730	656	589	532	482	439	402	369	
			2068	1772	1551	1241	1128	1034	954	886	827	775	730	656	589	532	482	439	402	369	
1,2		94,2	40	955	819	716	573	476	400	341	294	256	225	199	178	159	144	130	119	109	100
				955	819	716	573	476	400	341	294	256	225	199	178	159	144	130	114	101	89
	114,2	60	1240	1063	930	744	676	620	531	458	399	351	311	277	249	224	204	185	170	156	
			1240	1063	930	744	676	620	531	458	399	351	311	277	249	224	204	185	163	144	
	134,2	80	1524	1307	1143	915	831	762	704	645	562	494	438	390	350	316	287	261	239	220	
			1524	1307	1143	915	831	762	704	645	562	494	438	390	350	316	287	261	239	214	
	154,2	100	1809	1550	1357	1085	987	904	835	775	724	653	579	516	463	418	379	346	316	290	
			1809	1550	1357	1085	987	904	835	775	724	653	579	516	463	418	379	346	316	290	
	174,2	120	2049	1757	1537	1230	1118	1025	946	878	820	768	723	653	586	529	480	437	400	368	
			2049	1757	1537	1230	1118	1025	946	878	820	768	723	653	586	529	480	437	400	368	
	1,25	94,2	40	952	816	714	571	475	399	340	293	255	225	199	177	159	144	130	119	109	100
				952	816	714	571	475	399	340	293	255	225	199	177	159	144	130	114	101	89
114,2		60	1235	1059	927	741	674	618	530	457	398	350	310	277	248	224	203	185	169	156	
			1235	1059	927	741	674	618	530	457	398	350	310	277	248	224	203	185	163	144	
134,2		80	1519	1302	1139	911	829	760	701	645	562	494	437	390	350	316	287	261	239	219	
			1519	1302	1139	911	829	760	701	645	562	494	437	390	350	316	287	261	239	214	
154,2		100	1803	1545	1352	1082	983	901	832	773	721	653	578	516	463	418	379	345	316	290	
			1803	1545	1352	1082	983	901	832	773	721	653	578	516	463	418	379	345	316	290	
174,2		120	2045	1753	1534	1227	1115	1022	944	876	818	767	722	653	586	529	479	437	400	367	
			2045	1753	1534	1227	1115	1022	944	876	818	767	722	653	586	529	479	437	400	367	
1,5		94,2	40	936	802	702	561	472	397	338	292	254	223	198	176	158	143	130	118	108	99
				936	802	702	561	472	397	338	292	254	223	198	176	158	143	130	114	100	89
	114,2	60	1214	1041	911	729	662	607	528	455	396	348	308	275	247	223	202	184	169	155	
			1214	1041	911	729	662	607	528	455	396	348	308	275	247	223	202	184	162	144	
	134,2	80	1493	1280	1120	896	815	747	689	640	558	491	435	388	348	314	285	260	238	218	
			1493	1280	1120	896	815	747	689	640	558	491	435	388	348	314	285	260	238	213	
	154,2	100	1772	1519	1329	1063	967	886	818	760	709	649	575	513	460	415	377	343	314	288	
			1772	1519	1329	1063	967	886	818	760	709	649	575	513	460	415	377	343	314	288	
	174,2	120	2022	1733	1516	1213	1103	1011	933	866	809	758	713	649	583	526	477	435	398	365	
			2022	1733	1516	1213	1103	1011	933	866	809	758	713	649	583	526	477	435	398	365	

LEGENDA

Per la condizione di Stato Limite Ultimo (SLU) della soletta / *Ultimate limit-state design of the concrete slab (SLU)*

Per la condizione di Stato Limite di Esercizio (SLE) della soletta ($F \leq L/250$) / *Serviceability limit of the concrete slab (SLE) ($F \leq L/250$)*

I rapporti di prova pubblicati in questo catalogo vengono forniti a titolo puramente indicativo. I dati pubblicati sono stati calcolati secondo le Norme vigenti: NTC2018, Circolare esplicativa alle NTC2018, UNI EN 1993 (EC3). Per una corretta applicazione del prodotto sarà onere e cura del cliente e/o del progettista la redazione di calcoli appropriati con specifico riferimento al singolo impegno.

The test reports published in this catalogue are provided for indicative purposes only. The published data have been calculated according to the current regulations: NTC2018, Explanatory circular to NTC2018, UNI EN 1993 (EC3). For a correct application of the product, it will be responsibility and care of the customer and/or the designer to draw up appropriate calculations with specific reference to the individual use.

R/C 400 AM / LAMIERE DA SOLAIO CLS AM - CONCRETE SLAB CORRUGATED SHEETS



CLASSE / CLASS



PRODOTTI CERTIFICATI EPD
Criteri Ambientali Minimi (CAM)

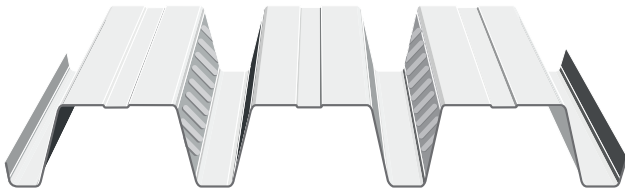

Lamiera grecata ad aderenza migliorata con greca alta e passo stretto, è ideale per solai con ampie luci. Disponibile anche in versione Deck per soffittatura o copertura. Può essere utilizzata come casseraforma (cassaforma) a perdere.

Corrugated metal sheet with improved adhesion with high rib and narrow pitch, it is ideal for floors with large spans. Also available in Deck version for ceiling or roof. It can be used as a disposable formwork.

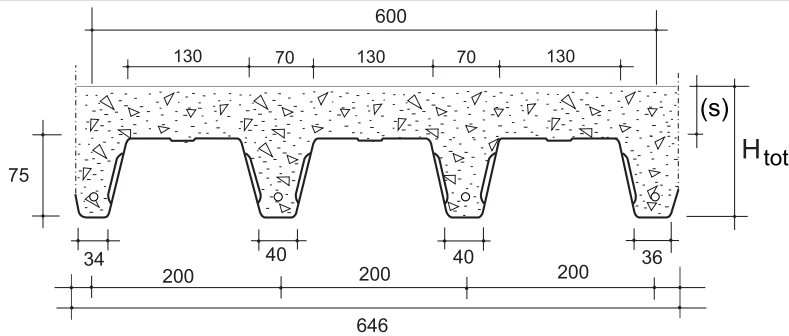

Caratteristiche tecniche - Datasheet

Dimensioni: larghezza 600 (mm), lunghezza a richiesta da produzione in continuo.

Spessori: fino a mm 1,5 - anche non standard su richiesta.

Supporti: acciaio zincato.

Alcune tipologie di acciaio, fornibili a richiesta previo accordo sui quantitativi minimi: S 235; S 250 GD+Z; S 260 NC; S 275; S 280 GD+Z; S 315 MC; S 315 NC; S 320 GD+Z (ed altri ancora).

Dimensions: width 600 (mm), length upon request from continuous production process.

Thicknesses (S): up to mm 1,5 - also non-standard on request.

Supports: galvanized steel.

Some types of steel supplied upon request previous agreement on minimum quantities: S 235; S 250 GD+Z; S 260 NC; S 275; S 280 GD+Z; S 315 MC; S 315 NC; S 320 GD+Z (and others more).

MODELLO LAMIERA GRECATO R/C 400 AM - ACCIAIO S 250 GD+Z / STEEL S 250 GD+Z CARATTERISTICHE STATICHE / STATIC CHARACTERISTICS														
CONDIZIONI DI PROGETTO COME ESEMPIO: LAMIERA GRECATO R/C 400 AM - LAMIERA A PERDERE - VERSO DI POSA: NORMALE - ACCIAIO S 250 GD sp. 15/10 mm														
APPOGGIO INTERMEDIO: CLS S ₃ int 100 mm - APPOGGIO LATERALE: CLS S ₃ lat 100 mm - TIPOLOGIA CLS: C 25/30														
ARMATURA INFERIORE N° 1 AD OGNI GRECA - DISPOSIZIONE CONTINUA - φ 8 - Copriferro (mm): 15														
RETE ARMATURA SUPERIORE: φ 6 - INTERASSE RETE: i= 200 mm - Copriferro (mm): 20														
ARMATURA SUPERIORE INTEGRATIVA APPOGGI INTERMEDI: φ 8 - INTERASSE: i= 200 mm - Copriferro (mm): 30														
PROPRIETA' DI MASSA EFFICACI: - EFFECTIVE MASS PROPERTIES:														
CARATTERISTICHE DELLA SOLETTA SLAB CHARACTERISTICS														
		MOMENTO POSITIVO IN CAMPATA POSITIVE MOMENT ON SPAN						MOMENTO NEGATIVO SULL'APPOGGIO NEGATIVE MOMENT ON SUPPORT						
Altezza caldana (s) Concrete slab height	Altezza soletta (H _{tot}) Total slab height	Peso soletta (P) Slab Weight	J _n	W _{cls}	W _{alamsup}	W _{ainf}	W _{alaminf}	J _n	W _{asup1}	W _{asup2}	W _{alamsup}	W _{ainf}	W _{cls}	W _{alaminf}
mm	mm	Kg/m	cm ⁴ /m	cm ³ /m	cm ³ /m	cm ³ /m	cm ³ /m	cm ⁴ /m	cm ³ /m	cm ³ /m	cm ³ /m	cm ³ /m	cm ³ /m	cm ³ /m
40	114,15	171,58	1276,54	762,53	-531,69	-156,33	-131,05	1138,76	180,26	214,15	268,42	-747,93	-376,76	-367,63
50	124,15	197,06	1565,99	890,32	-472,24	-172,45	-146,96	1457,31	204,92	238,45	361,02	-843,17	-451,41	-441,16
60	134,15	222,55	1886,22	1024,95	-445,42	-188,63	-162,96	1817,75	229,68	262,90	473,47	-943,90	-530,61	-519,24
80	154,15	273,51	2619,44	1313,46	-430,78	-221,13	-195,18	2665,87	279,41	312,13	769,14	-1159,59	-701,73	-688,15
100	174,15	324,48	3476,92	1625,90	-438,09	-253,76	-227,60	3685,95	329,34	361,65	1182,51	-1392,00	-888,62	-872,84
120	194,15	375,45	4459,28	1960,62	-455,00	-286,48	-260,16	4880,30	379,40	411,38	1750,40	-1639,39	-1090,11	-1072,15

TABELLA DI PORTATA R/C 400 AM: ACCIAIO S 250 GD / LOAD TABLE R/C 400 AM: STEEL S 250 GD

PORTATA DEL PROFILO IN daN/m ² CON FRECCIA ≤ L/250 / SHEET CAPACITY, daN/m ² WITH DEFLECTION ≤ L/250 OF A SPAN																					
sp. lamiera thickness	sp. soletta slab height	sp. caldana concrete height	 Distanza tra gli appoggi "L" in metri / Pitch "L" in metres between the supports																		
			1,5	1,75	2	2,5	2,75	3	3,25	3,5	3,75	4	4,25	4,5	4,75	5	5,25	5,5	5,75	6	
0,8	114,15	40	1600	1372	1200	960	873	800	707	610	531	467	414	369	331	299	271	247	226	208	
			1600	1372	1200	832	629	488	387	312	256	213	179	152	131	113	99	87	77	68	
	134,15	60	1892	1622	1419	1135	1032	946	853	736	641	563	499	445	400	361	327	298	273	250	
			1892	1622	1419	1135	926	718	569	459	376	312	262	223	191	165	144	127	112	100	
	154,15	80	2184	1872	1638	1310	1191	1092	1000	863	751	660	585	522	468	423	383	349	320	294	
			2184	1872	1638	1310	1191	996	789	636	521	433	364	309	265	229	200	176	155	138	
	174,15	100	2700	2314	2025	1620	1473	1347	1148	990	862	758	671	599	537	485	440	401	367	337	
			2700	2314	2025	1620	1473	1324	1048	845	693	575	484	411	353	305	266	234	206	183	
	194,15	120	2922	2505	2192	1753	1594	1461	1296	1118	973	856	758	676	607	548	497	453	414	380	
			2922	2505	2192	1753	1594	1461	1296	1087	891	740	622	529	454	393	343	301	266	237	
	1,0	114,15	40	1600	1372	1200	960	873	800	707	610	531	467	414	369	331	299	271	247	226	208
				1600	1372	1200	832	629	488	387	312	256	213	179	152	131	113	99	87	77	68
134,15		60	1892	1622	1419	1135	1032	946	853	736	641	563	499	445	400	361	327	298	273	250	
			1892	1622	1419	1135	926	718	569	459	376	312	262	223	191	165	144	127	112	99	
154,15		80	2184	1872	1638	1310	1191	1092	1000	863	751	660	585	522	468	423	383	349	320	294	
			2184	1872	1638	1310	1191	996	789	636	521	433	364	309	265	229	200	176	155	138	
174,15		100	2700	2314	2025	1620	1473	1347	1148	990	862	758	671	599	537	485	440	401	367	337	
			2700	2314	2025	1620	1473	1323	1048	845	693	575	484	411	353	305	266	234	206	183	
194,15		120	2922	2505	2192	1753	1594	1461	1296	1118	973	856	758	676	607	548	497	453	414	380	
			2922	2505	2192	1753	1594	1461	1296	1087	891	740	622	529	454	393	343	301	266	237	
1,2		114,15	40	1600	1372	1200	960	873	800	707	610	531	467	414	369	331	299	271	247	226	208
				1600	1372	1200	832	629	488	387	312	256	213	179	152	130	113	99	87	77	68
	134,15	60	1892	1622	1419	1135	1032	946	853	736	641	563	499	445	400	361	327	298	273	250	
			1892	1622	1419	1135	926	718	568	458	376	312	262	223	191	165	144	127	112	99	
	154,15	80	2184	1872	1638	1310	1191	1092	1000	863	751	660	585	522	468	423	383	349	320	294	
			2184	1872	1638	1310	1191	996	789	636	521	433	364	309	265	229	200	175	155	138	
	174,15	100	2700	2314	2025	1620	1473	1347	1148	990	862	758	671	599	537	485	440	401	367	337	
			2700	2314	2025	1620	1473	1323	1048	845	692	575	484	411	352	305	266	233	206	183	
	194,15	120	2922	2505	2192	1753	1594	1461	1296	1118	973	856	758	676	607	548	497	453	414	380	
			2922	2505	2192	1753	1594	1461	1296	1087	891	740	622	529	454	393	343	301	266	236	
	1,25	114,15	40	1600	1372	1200	960	873	800	707	610	531	467	414	369	331	299	271	247	226	208
				1600	1372	1200	832	629	488	387	312	256	213	179	152	130	113	99	87	77	68
134,15		60	1892	1622	1419	1135	1032	946	853	736	641	563	499	445	400	361	327	298	273	250	
			1892	1622	1419	1135	926	718	568	458	376	312	262	223	191	165	144	127	112	99	
154,15		80	2184	1872	1638	1310	1191	1092	1000	863	751	660	585	522	468	423	383	349	320	294	
			2184	1872	1638	1310	1191	996	789	636	521	433	364	309	265	229	200	175	155	138	
174,15		100	2700	2314	2025	1620	1473	1347	1148	990	862	758	671	599	537	485	440	401	367	337	
			2700	2314	2025	1620	1473	1323	1048	845	692	575	484	411	352	305	266	233	206	183	
194,15		120	2922	2505	2192	1753	1594	1461	1296	1118	973	856	758	676	607	548	497	453	414	380	
			2922	2505	2192	1753	1594	1461	1296	1087	890	740	622	529	454	393	343	301	266	236	
1,5		114,15	40	1600	1372	1200	960	873	800	707	610	531	467	414	369	331	299	271	247	226	208
				1600	1372	1200	831	629	488	386	312	256	212	179	152	130	113	99	87	77	68
	134,15	60	1892	1622	1419	1135	1032	946	853	736	641	563	499	445	400	361	327	298	273	250	
			1892	1622	1419	1135	926	718	568	458	376	312	262	223	191	165	144	127	112	99	
	154,15	80	2184	1872	1638	1310	1191	1092	1000	863	751	660	585	522	468	423	383	349	320	294	
			2184	1872	1638	1310	1191	996	789	636	521	433	364	309	265	229	200	175	155	138	
	174,15	100	2700	2314	2025	1620	1473	1347	1148	990	862	758	671	599	537	485	440	401	367	337	
			2700	2314	2025	1620	1473	1323	1048	845	692	575	483	411	352	305	266	233	206	183	
	194,15	120	2922	2505	2192	1753	1594	1461	1296	1118	973	856	758	676	607	548	497	453	414	380	
			2922	2505	2192	1753	1594	1461	1296	1086	890	740	622	529	454	393	342	301	266	236	

LEGENDA

Per la condizione di Stato Limite Ultimo (SLU) della soletta / *Ultimate limit-state design of the concrete slab (SLU)*

Per la condizione di Stato Limite di Esercizio (SLE) della soletta ($F \leq L/250$) / *Serviceability limit of the concrete slab (SLE) ($F \leq L/250$)*

I rapporti di prova pubblicati in questo catalogo vengono forniti a titolo puramente indicativo. I dati pubblicati sono stati calcolati secondo le Norme vigenti: NTC2018, Circolare esplicativa alle NTC2018, UNI EN 1993 (EC3). Per una corretta applicazione del prodotto sarà onere e cura del cliente e/o del progettista la redazione di calcoli appropriati con specifico riferimento al singolo impiego.

The test reports published in this catalogue are provided for indicative purposes only. The published data have been calculated according to the current regulations: NTC2018, Explanatory circular to NTC2018, UNI EN 1993 (EC3). For a correct application of the product, it will be responsibility and care of the customer and/or the designer to draw up appropriate calculations with specific reference to the individual use.

TABELLA DI PORTATA R/C 400 AM: ACCIAIO S 250 GD / LOAD TABLE R/C 400 AM: STEEL S 250 GD

PORTATA DEL PROFILO IN daN/m ² CON FRECCIA ≤ L/250 / SHEET CAPACITY, daN /m ² WITH DEFLECTION ≤ L/250 OF A SPAN																				
sp. lamiera thickness (mm)	sp. soletta slab height (mm)	sp. caldara concrete height (mm)	 Distanza tra gli appoggi "L" in metri / Pitch "L" in metres between the supports																	
			1,5	1,75	2	2,5	2,75	3	3,25	3,5	3,75	4	4,25	4,5	4,75	5	5,25	5,5	5,75	6
0,8	114,15	40	1587	1360	1190	771	637	535	456	393	343	301	267	238	213	193	175	159	146	134
			1587	1360	1190	771	637	535	456	393	343	301	267	238	213	193	175	159	146	134
	134,15	60	1929	1654	1447	1085	897	754	642	554	482	424	376	335	301	271	246	224	205	188
			1929	1654	1447	1085	897	754	642	554	482	424	376	335	301	271	246	224	205	188
	154,15	80	2163	1854	1622	1298	1180	997	849	732	638	561	497	443	398	359	326	297	271	249
			2163	1854	1622	1298	1180	997	849	732	638	561	497	443	398	359	326	297	271	249
	174,15	100	2384	2044	1788	1431	1301	1192	1076	927	808	710	629	561	504	454	412	376	344	316
			2384	2044	1788	1431	1301	1192	1076	927	808	710	629	561	504	454	412	376	344	316
	194,15	120	2596	2225	1947	1558	1416	1298	1198	1113	991	871	772	688	618	557	506	461	422	387
			2596	2225	1947	1558	1416	1298	1198	1113	991	871	772	688	618	557	506	461	422	387
1,0	114,15	40	1587	1360	1190	771	637	535	456	393	343	301	267	238	213	193	175	159	146	134
			1587	1360	1190	771	637	535	456	393	343	301	267	238	213	193	175	159	146	134
	134,15	60	1929	1654	1447	1085	897	754	642	554	482	424	376	335	301	271	246	224	205	188
			1929	1654	1447	1085	897	754	642	554	482	424	376	335	301	271	246	224	205	188
	154,15	80	2163	1854	1622	1298	1180	997	849	732	638	561	497	443	398	359	326	297	271	249
			2163	1854	1622	1298	1180	997	849	732	638	561	497	443	398	359	326	297	271	249
	174,15	100	2384	2044	1788	1431	1301	1192	1076	927	808	710	629	561	504	454	412	376	344	316
			2384	2044	1788	1431	1301	1192	1076	927	808	710	629	561	504	454	412	376	344	316
	194,15	120	2596	2225	1947	1558	1416	1298	1198	1113	991	871	772	688	618	557	506	461	422	387
			2596	2225	1947	1558	1416	1298	1198	1113	991	871	772	688	618	557	506	461	422	387
1,2	114,15	40	1587	1360	1190	771	637	535	456	393	343	301	267	238	213	193	175	159	146	134
			1587	1360	1190	771	637	535	456	393	343	301	267	238	213	193	175	159	146	134
	134,15	60	1929	1654	1447	1085	897	754	642	554	482	424	376	335	301	271	246	224	205	188
			1929	1654	1447	1085	897	754	642	554	482	424	376	335	301	271	246	224	205	188
	154,15	80	2163	1854	1622	1298	1180	997	849	732	638	561	497	443	398	359	326	297	271	249
			2163	1854	1622	1298	1180	997	849	732	638	561	497	443	398	359	326	297	271	249
	174,15	100	2384	2044	1788	1431	1301	1192	1076	927	808	710	629	561	504	454	412	376	344	316
			2384	2044	1788	1431	1301	1192	1076	927	808	710	629	561	504	454	412	376	344	316
	194,15	120	2596	2225	1947	1558	1416	1298	1198	1113	991	871	772	688	618	557	506	461	422	387
			2596	2225	1947	1558	1416	1298	1198	1113	991	871	772	688	618	557	506	461	422	387
1,25	114,15	40	1587	1360	1190	771	637	535	456	393	343	301	267	238	213	193	175	159	146	134
			1587	1360	1190	771	637	535	456	393	343	301	267	238	213	193	175	159	146	134
	134,15	60	1929	1654	1447	1085	897	754	642	554	482	424	376	335	301	271	246	224	205	188
			1929	1654	1447	1085	897	754	642	554	482	424	376	335	301	271	246	224	205	188
	154,15	80	2163	1854	1622	1298	1180	997	849	732	638	561	497	443	398	359	326	297	271	249
			2163	1854	1622	1298	1180	997	849	732	638	561	497	443	398	359	326	297	271	249
	174,15	100	2384	2044	1788	1431	1301	1192	1076	927	808	710	629	561	504	454	412	376	344	316
			2384	2044	1788	1431	1301	1192	1076	927	808	710	629	561	504	454	412	376	344	316
	194,15	120	2596	2225	1947	1558	1416	1298	1198	1113	991	871	772	688	618	557	506	461	422	387
			2596	2225	1947	1558	1416	1298	1198	1113	991	871	772	688	618	557	506	461	422	387
1,5	114,15	40	1587	1360	1190	771	637	535	456	393	343	301	267	238	213	193	175	159	146	134
			1587	1360	1190	771	637	535	456	393	343	301	267	238	213	193	175	159	146	134
	134,15	60	1929	1654	1447	1085	897	754	642	554	482	424	376	335	301	271	246	224	205	188
			1929	1654	1447	1085	897	754	642	554	482	424	376	335	301	271	246	224	205	188
	154,15	80	2163	1854	1622	1298	1180	997	849	732	638	561	497	443	398	359	326	297	271	249
			2163	1854	1622	1298	1180	997	849	732	638	561	497	443	398	359	326	297	271	249
	174,15	100	2384	2044	1788	1431	1301	1192	1076	927	808	710	629	561	504	454	412	376	344	316
			2384	2044	1788	1431	1301	1192	1076	927	808	710	629	561	504	454	412	376	344	316
	194,15	120	2596	2225	1947	1558	1416	1298	1198	1113	991	871	772	688	618	557	506	461	422	387
			2596	2225	1947	1558	1416	1298	1198	1113	991	871	772	688	618	557	506	461	422	387

LEGENDA

Per la condizione di Stato Limite Ultimo (SLU) della soletta / *Ultimate limit-state design of the concrete slab (SLU)*

Per la condizione di Stato Limite di Esercizio (SLE) della soletta ($F \leq L/250$) / *Serviceability limit of the concrete slab (SLE) ($F \leq L/250$)*

I rapporti di prova pubblicati in questo catalogo vengono forniti a titolo puramente indicativo. I dati pubblicati sono stati calcolati secondo le Norme vigenti: NTC2018, Circolare esplicativa alle NTC2018, UNI EN 1993 (EC3). Per una corretta applicazione del prodotto sarà onere e cura del cliente e/o del progettista la redazione di calcoli appropriati con specifico riferimento al singolo impiego.

The test reports published in this catalogue are provided for indicative purposes only. The published data have been calculated according to the current regulations: NTC2018, Explanatory circular to NTC2018, UNI EN 1993 (EC3). For a correct application of the product, it will be responsibility and care of the customer and/or the designer to draw up appropriate calculations with specific reference to the individual use.

TABELLA DI PORTATA R/C 400 AM: ACCIAIO S 250 GD / LOAD TABLE R/C 400 AM: STEEL S 250 GD

PORTATA DEL PROFILO IN daN/m ² CON FRECCIA ≤ L/250 / SHEET CAPACITY, daN/m ² WITH DEFLECTION ≤ L/250 OF A SPAN																					
sp. lamiera thickness	sp. soletta slab height	sp. caldama concrete height	 Distanza tra gli appoggi "L" in metri / Pitch "L" in metres between the supports																		
			1,5	1,75	2	2,5	2,75	3	3,25	3,5	3,75	4	4,25	4,5	4,75	5	5,25	5,5	5,75	6	
0,8	114,15	40	1653	1417	1240	963	796	669	570	492	428	376	333	297	267	241	218	199	182	167	
			1653	1417	1240	963	796	669	570	492	428	376	333	283	242	209	182	159	141	125	
	134,15	60	2010	1723	1507	1206	1096	942	803	692	603	530	469	419	376	339	308	280	256	236	
			2010	1723	1507	1206	1096	942	803	692	603	530	469	415	355	307	267	234	206	183	
	154,15	80	2253	1931	1690	1352	1229	1126	1040	915	797	701	621	554	497	449	407	371	339	312	
			2253	1931	1690	1352	1229	1126	1040	915	797	701	621	554	493	425	370	324	286	253	
	174,15	100	2484	2129	1863	1490	1355	1242	1146	1064	993	888	786	701	629	568	515	469	430	394	
			2484	2129	1863	1490	1355	1242	1146	1064	993	888	786	701	629	566	492	431	380	337	
	194,15	120	2704	2318	2028	1622	1475	1352	1248	1159	1082	1014	954	860	772	697	632	576	527	484	
			2704	2318	2028	1622	1475	1352	1248	1159	1082	1014	954	860	772	697	632	555	489	434	
	1,0	114,15	40	1653	1417	1240	963	796	669	570	492	428	376	333	297	267	241	218	199	182	167
				1653	1417	1240	963	796	669	570	492	428	376	333	283	242	209	182	159	141	125
134,15		60	2010	1723	1507	1206	1096	942	803	692	603	530	469	419	376	339	308	280	256	236	
			2010	1723	1507	1206	1096	942	803	692	603	530	469	415	355	307	267	234	206	183	
154,15		80	2253	1931	1690	1352	1229	1126	1040	915	797	701	621	554	497	449	407	371	339	312	
			2253	1931	1690	1352	1229	1126	1040	915	797	701	621	554	493	425	370	324	286	253	
174,15		100	2484	2129	1863	1490	1355	1242	1146	1064	993	888	786	701	629	568	515	469	430	394	
			2484	2129	1863	1490	1355	1242	1146	1064	993	888	786	701	629	565	492	431	380	337	
194,15		120	2704	2318	2028	1622	1475	1352	1248	1159	1082	1014	954	860	772	697	632	576	527	484	
			2704	2318	2028	1622	1475	1352	1248	1159	1082	1014	954	860	772	697	632	554	489	434	
1,2		114,15	40	1653	1417	1240	963	796	669	570	492	428	376	333	297	267	241	218	199	182	167
				1653	1417	1240	963	796	669	570	492	428	376	333	283	242	209	182	159	141	125
	134,15	60	2010	1723	1507	1206	1096	942	803	692	603	530	469	419	376	339	308	280	256	236	
			2010	1723	1507	1206	1096	942	803	692	603	530	469	415	355	307	267	234	206	183	
	154,15	80	2253	1931	1690	1352	1229	1126	1040	915	797	701	621	554	497	449	407	371	339	312	
			2253	1931	1690	1352	1229	1126	1040	915	797	701	621	554	493	425	370	324	285	253	
	174,15	100	2484	2129	1863	1490	1355	1242	1146	1064	993	888	786	701	629	568	515	469	430	394	
			2484	2129	1863	1490	1355	1242	1146	1064	993	888	786	701	629	565	492	431	380	337	
	194,15	120	2704	2318	2028	1622	1475	1352	1248	1159	1082	1014	954	860	772	697	632	576	527	484	
			2704	2318	2028	1622	1475	1352	1248	1159	1082	1014	954	860	772	697	632	554	489	434	
	1,25	114,15	40	1653	1417	1240	963	796	669	570	492	428	376	333	297	267	241	218	199	182	167
				1653	1417	1240	963	796	669	570	492	428	376	333	283	242	209	182	159	141	125
134,15		60	2010	1723	1507	1206	1096	942	803	692	603	530	469	419	376	339	308	280	256	236	
			2010	1723	1507	1206	1096	942	803	692	603	530	469	415	355	307	267	234	206	183	
154,15		80	2253	1931	1690	1352	1229	1126	1040	915	797	701	621	554	497	449	407	371	339	312	
			2253	1931	1690	1352	1229	1126	1040	915	797	701	621	554	493	425	370	324	285	253	
174,15		100	2484	2129	1863	1490	1355	1242	1146	1064	993	888	786	701	629	568	515	469	430	394	
			2484	2129	1863	1490	1355	1242	1146	1064	993	888	786	701	629	565	492	431	380	337	
194,15		120	2704	2318	2028	1622	1475	1352	1248	1159	1082	1014	954	860	772	697	632	576	527	484	
			2704	2318	2028	1622	1475	1352	1248	1159	1082	1014	954	860	772	697	632	554	489	433	
1,5		114,15	40	1653	1417	1240	963	796	669	570	492	428	376	333	297	267	241	218	199	182	167
				1653	1417	1240	963	796	669	570	492	428	376	333	283	242	209	182	159	140	125
	134,15	60	2010	1723	1507	1206	1096	942	803	692	603	530	469	419	376	339	308	280	256	236	
			2010	1723	1507	1206	1096	942	803	692	603	530	469	415	355	307	267	234	206	183	
	154,15	80	2253	1931	1690	1352	1229	1126	1040	915	797	701	621	554	497	449	407	371	339	312	
			2253	1931	1690	1352	1229	1126	1040	915	797	701	621	554	493	425	370	324	285	253	
	174,15	100	2484	2129	1863	1490	1355	1242	1146	1064	993	888	786	701	629	568	515	469	430	394	
			2484	2129	1863	1490	1355	1242	1146	1064	993	888	786	701	629	565	492	431	380	337	
	194,15	120	2704	2318	2028	1622	1475	1352	1248	1159	1082	1014	954	860	772	697	632	576	527	484	
			2704	2318	2028	1622	1475	1352	1248	1159	1082	1014	954	860	772	697	632	554	489	433	

LEGENDA

Per la condizione di Stato Limite Ultimo (SLU) della soletta / *Ultimate limit-state design of the concrete slab (SLU)*

Per la condizione di Stato Limite di Esercizio (SLE) della soletta ($F \leq L/250$) / *Serviceability limit of the concrete slab (SLE) ($F \leq L/250$)*

I rapporti di prova pubblicati in questo catalogo vengono forniti a titolo puramente indicativo. I dati pubblicati sono stati calcolati secondo le Norme vigenti: NTC2018, Circolare esplicativa alle NTC2018, UNI EN 1993 (EC3). Per una corretta applicazione del prodotto sarà onere e cura del cliente e/o del progettista la redazione di calcoli appropriati con specifico riferimento al singolo impiego.

The test reports published in this catalogue are provided for indicative purposes only. The published data have been calculated according to the current regulations: NTC2018, Explanatory circular to NTC2018, UNI EN 1993 (EC3). For a correct application of the product, it will be responsibility and care of the customer and/or the designer to draw up appropriate calculations with specific reference to the individual use.



Ampex è l'esclusivo sistema strutturale per la copertura di grandi luci fino a 12 metri senza appoggi intermedi, che si contraddistingue per la particolare sezione del profilo, frutto di studi condotti dal **Centro Ricerche Isolpack** e oggetto di brevetto.

La complessità di fabbricazione e l'utilizzo di impianti appositamente progettati e realizzati per la lavorazione contemporanea delle lamiere nei due sensi, fanno di **Isolpack** la sola produttrice in Italia di questo prodotto dalle caratteristiche uniche.

Grazie a queste innovative caratteristiche, il sistema **Ampex** è stato scelto dai più prestigiosi studi di progettazione e General Contractors italiani ed internazionali.

Ampex rappresenta senza dubbio l'emblema della capacità di **Isolpack** di rispondere alle esigenze del mercato e di tradurle in prodotti performanti, grazie agli studi nel settore Ricerca e Sviluppo e ad impianti che combinano elevato e costante standard qualitativo e notevole potenzialità produttiva.

Ampex is the patented exclusive structural system for covering large spans up to 12 meters with no intermediate supports, which is characterized by the particular section of the profile, it is the result of studies conducted by the **Isolpack Research Center**.

The complexity of manufacturing and the use of specially designed and built systems for the simultaneous processing of the sheet metal in both directions make **Isolpack** the only producer in Italy of this product with unique characteristics.

Thanks to these innovative features, the **Ampex** system has been chosen by the most prestigious Italian and international design studios and General Contractors.

Ampex undoubtedly represents the emblem of **Isolpack's** ability to respond to market needs and translate them into performing products, thanks to studies in the Research and Development sector and plants that combine high and constant quality standards and considerable production potential.

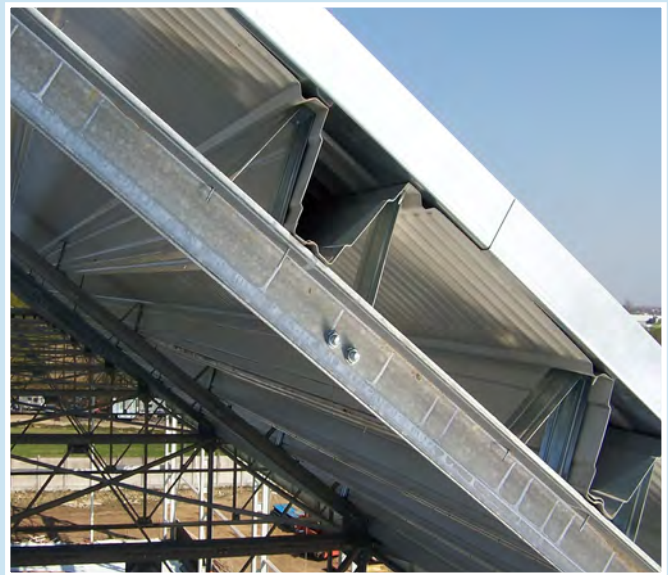



CLASSE / CLASS

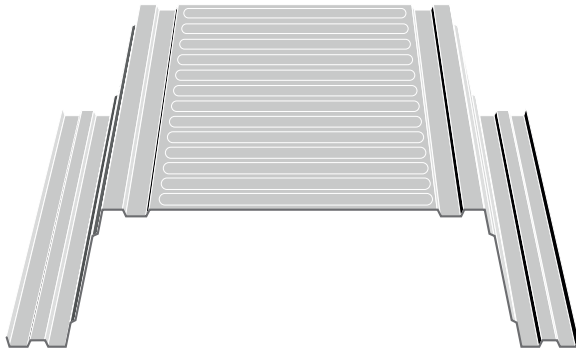

Superando la necessità di arcarecci e controventature, Ampex libera la creatività progettuale. Versatile, leggero, facile da montare, trova larghissima applicazione per nuove infrastrutture di grandi dimensioni in ambito industriale e commerciale.

Thanks to overcoming the need for purlins and bracing, Ampex releases design creativity. Suitable for many uses, light, easy to assemble, it is widely used for new infrastructures and large buildings in the industrial and commercial fields.

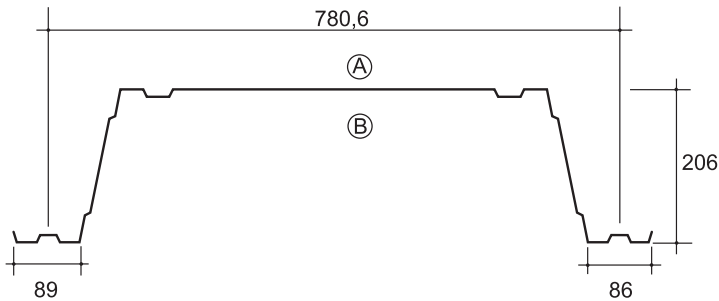

Staffa speciale in acciaio zincato nervato.

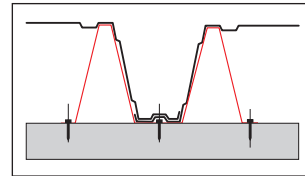

Special ribbed galvanized steel frame.

Nei disegni, A o B indicano il lato preverniciato desiderato.
In the drawings A or B show the wished prepainted side.

Caratteristiche tecniche - Datasheet

Dimensioni: larghezza 780,6 (mm), lunghezza a richiesta da produzione in continuo.

Spessori: da mm 0,8 a mm 1,5 - anche non standard su richiesta.

Supporti: acciaio zincato o preverniciato

Alcune tipologie di acciaio, fornibili a richiesta previo accordo sui quantitativi minimi: S 235; S 250 GD+Z; S 260 NC; S 275; S 280 GD+Z; S 315 MC; S 315 NC; S 320 GD+Z (ed altri ancora).

Trattamenti protettivi applicabili a richiesta: Preverniciatura con poliestere.

Dimensions: width 780,6 (mm), length upon request from continuous production process.

Thicknesses (S): from mm 0,8 to mm 1,5 - also non-standard on request.

Supports: prepainted or galvanized steel.

Some types of steel supplied upon request previous agreement on minimum quantities: S 235; S 250 GD+Z; S 260 NC; S 275; S 280 GD+Z; S 315 MC; S 315 NC; S 320 GD+Z (and others more).

Protective treatments for external support available on request: Pre-painting with polyester.

CARATTERISTICHE GEOMETRICHE / GEOMETRICAL CHARACTERISTICS								
	Spessore / thickness (mm)	0,80	0,90	1,00	1,10	1,20	1,25	1,50
AMPEX NORMALE NORMAL AMPEX	A [cm ² /m]	12,41	13,96	15,51	17,06	18,61	19,39	23,26
	Peso [daN/m ²]	9,74	10,96	12,17	13,39	14,61	15,22	18,26
	J [cm ⁴ /m]	793,64	892,85	992,06	1091,27	1190,48	1240,09	1488,12
	Wsup [cm ³ /m]	118,75	133,59	148,44	163,28	178,12	185,55	222,66
	Winf [cm ³ /m]	57,57	64,76	71,96	79,16	86,35	89,95	107,94
AMPEX ROVESCIO REVERSE AMPEX	A [cm ² /m]	12,41	13,96	15,51	17,06	18,61	19,39	23,26
	Peso [daN/m ²]	9,74	10,96	12,17	13,39	14,61	15,22	18,26
	J [cm ⁴ /m]	793,64	892,85	992,06	1091,27	1190,48	1240,09	1488,12
	Wsup [cm ³ /m]	57,57	64,76	71,96	79,16	86,35	89,95	107,94
	Winf [cm ³ /m]	118,75	133,59	148,44	163,28	178,12	185,55	222,66



Per poter realizzare una trave continua anche in caso di luce considerevole tra gli appoggi, lo schema di calcolo dell'elemento strutturale Ampex è basato sul concetto di trave Gerber. Essa consiste in una trave con più di due appoggi, resa isostatica mediante un numero conveniente di cerniere (vedi figura 01) posizionate nei punti in cui si annulla il momento flettente. Con questo criterio si scompone quindi la trave continua in un insieme di "travi semplicemente appoggiate", le quali, una volta assemblate in opera, ricompongono la trave continua. I dati di partenza devono essere il carico uniformemente ripartito, il numero delle campate, la luce tra gli appoggi e la limitazione di freccia ($F \leq L/200$ copertura) per $L/400$ (per solai).

In order to create a continuous beam even in the case of considerable span between the supports, the calculation scheme of the Ampex structural element is based on the concept of the Gerber beam. It consists of a beam with more than two supports, made isostatic by means of a convenient number of hinges (see figure 01) positioned in the points where the bending moment is canceled. With this criteria the continuous beam is then broken down into a set of "simply supported beams", which, once assembled on site, recombine the continuous beam. The starting data must be the uniformly distributed load, the number of spans, the span between the supports and the deflection limit ($f \leq L/200$ coverage) for $L/400$ (for floors).

Le tabelle di portata pubblicate in questo catalogo, calcolate secondo le Norme: NTC2018, Circolare esplicativa alle NTC2018, UNI EN 1993 (EC3), sono organizzate in modo diverso rispetto ai cataloghi precedenti e più facilmente interpretabili: lo spessore della lamiera diventa un valore di input, così come lo schema statico nel suo insieme (numero di campate, luce L, limite superiore dello spostamento verticale allo SLE). La consultazione delle tabelle è immediata, con i valori massimi delle portate (q) sostenibili dalla lamiera e le lunghezze ideali degli sbalzi.

The test reports tables published in this catalogue, calculated according to the Standards: NTC2018, Explanatory Circular to NTC2018, UNI EN 1993 (EC3), are organized in a different way than in previous catalogues and more easily interpretable: the thickness of the metal sheet becomes an input value, as well as the static diagram as a whole (number of spans, span L, upper limit of vertical displacement to the SLS). The consultation of the tables is immediate, with the maximum values of the capacities (q) that can be sustained by the sheet and the ideal lengths of the overhangs.

**LUNGHEZZE DEGLI SBALZI OTTIMIZZATE (FIG. 01)
OPTIMIZED OVERHANG LENGTHS (FIG. 01)**

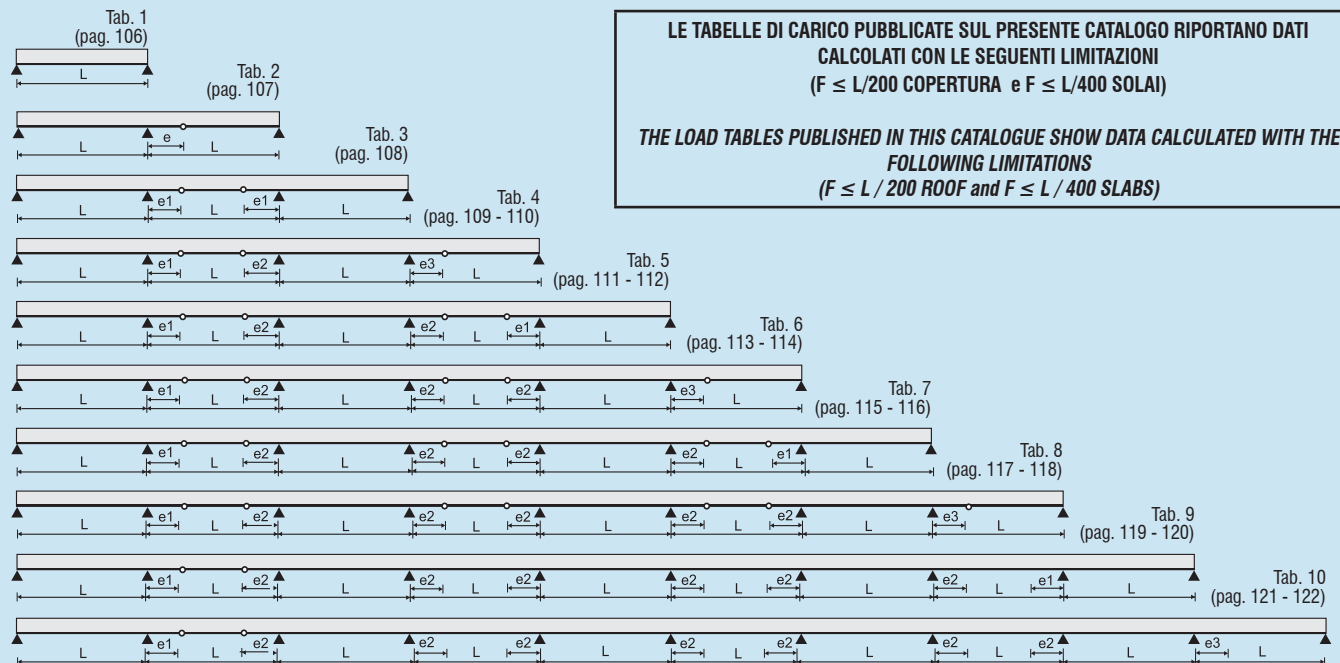

**LA CERNIERA GERBER
THE GERBER HINGE**

Il giunto a cerniera (giunto di eccentricità - e; e1; e2; e3) è realizzato mediante una sovrapposizione delle estremità degli elementi strutturali Ampex di 200 mm con una rivettatura realizzata con rivetti in acciaio di Ø 4,8 mm, così composta: n. 2 rivetti su ognuna delle facce inclinate; n. 1 rivetto disposto nel mezzo della parte piana superiore (vedere fig. a lato).

The hinge joint (eccentricity joint - e; e1; e2; e3) is made by overlapping the ends of the Ampex structural elements by 200 mm with a riveting made with steel rivets of Ø 4.8 mm, composed as follows: n. 2 rivets on each of the inclined faces; n. 1 rivet placed in the middle of the upper flat part (see fig. On the side).

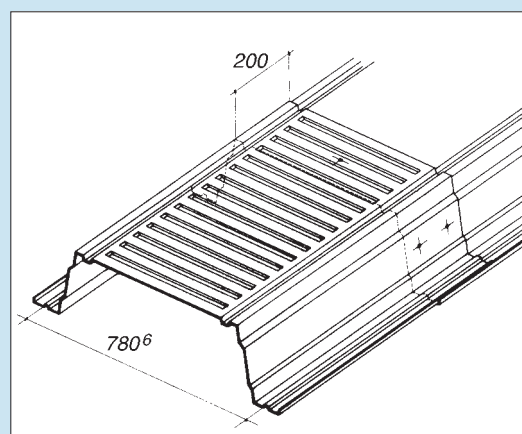



TABELLA (1) DI PORTATA AMPEX: ACCIAIO S 250 GD / LOAD TABLE AMPEX: STEEL S 250 GD

I valori di portata in tabella non includono il peso proprio della lamiera grecata.
The capacity load shown in the table does not include the weight of the metal sheet itself.

		PORTATA DEL PROFILO CON FRECCIA $\leq L/200$ / SHEET CAPACITY WITH DEFLECTION $\leq L/200$ OF A SPAN																
Spessore / thickness	Carico Limite Limit Design Deflection																	
		CARICHI MASSIMI [kg/m ²] E LUNGHEZZE IDEALI DEGLI SBALZI PER TRAVE GERBER (e) [cm]																
mm	kg/m ²	4	4,5	5	5,5	6	6,5	7	7,5	8	8,5	9	9,5	10	10,5	11	11,5	12
0,8	SLU	624	493	399	330	277	236	204	177	156	138	123	111	100	91	83	75	69
	SLE	624	493	399	304	234	184	148	120	99	82	69	59	51	44	38	33	29
0,9	SLU	706	558	452	374	314	267	231	201	177	156	140	125	113	102	93	85	78
	SLE	706	558	452	346	267	210	168	137	113	94	79	67	58	50	43	38	33
1,0	SLU	788	623	504	417	350	298	257	224	197	175	156	140	126	114	104	95	88
	SLE	788	623	504	387	298	235	188	153	126	105	88	75	64	56	48	42	37
1,1	SLU	870	688	557	460	387	330	284	248	218	193	172	154	139	126	115	105	97
	SLE	870	688	557	429	330	260	208	169	139	116	98	83	71	62	54	47	41
1,2	SLU	953	753	610	504	423	361	311	271	238	211	188	169	152	138	126	115	106
	SLE	953	753	610	470	362	285	228	185	153	127	107	91	78	68	59	51	45
1,25	SLU	994	785	636	526	442	376	325	283	248	220	196	176	159	144	131	120	110
	SLE	994	785	636	491	378	298	238	194	160	133	112	95	82	71	61	54	47
1,5	SLU	1202	950	769	636	534	455	392	342	301	266	237	213	192	174	159	145	134
	SLE	1202	950	769	597	460	362	290	235	194	162	136	116	99	86	75	65	57

		PORTATA DEL PROFILO CON FRECCIA $\leq L/400$ / SHEET CAPACITY WITH DEFLECTION $\leq L/400$ OF A SPAN																
Spessore / thickness	Carico Limite Limit Design Deflection																	
		CARICHI MASSIMI [kg/m ²] E LUNGHEZZE IDEALI DEGLI SBALZI PER TRAVE GERBER (e) [cm]																
mm	kg/m ²	4	4,5	5	5,5	6	6,5	7	7,5	8	8,5	9	9,5	10	10,5	11	11,5	12
0,8	SLU	624	493	399	330	277	236	204	177	156	138	123	111	100	91	83	75	69
	SLE	395	278	202	152	117	92	74	60	49	41	35	30	25	22	19	17	15
0,9	SLU	706	558	452	374	314	267	231	201	177	156	140	125	113	102	93	85	78
	SLE	450	316	230	173	133	105	84	68	56	47	40	34	29	25	22	19	17
1,0	SLU	788	623	504	417	350	298	257	224	197	175	156	140	126	114	104	95	88
	SLE	503	354	258	194	149	117	94	76	63	52	44	38	32	28	24	21	19
1,1	SLU	870	688	557	460	387	330	284	248	218	193	172	154	139	126	115	105	97
	SLE	557	391	285	214	165	130	104	85	70	58	49	42	36	31	27	23	21
1,2	SLU	953	753	610	504	423	361	311	271	238	211	188	169	152	138	126	115	106
	SLE	611	429	313	235	181	142	114	93	76	64	54	46	39	34	29	26	23
1,25	SLU	994	785	636	526	442	376	325	283	248	220	196	176	159	144	131	120	110
	SLE	639	448	327	246	189	149	119	97	80	67	56	48	41	35	31	27	24
1,5	SLU	1202	950	769	636	534	455	392	342	301	266	237	213	192	174	159	145	134
	SLE	776	545	397	299	230	181	145	118	97	81	68	58	50	43	37	33	29

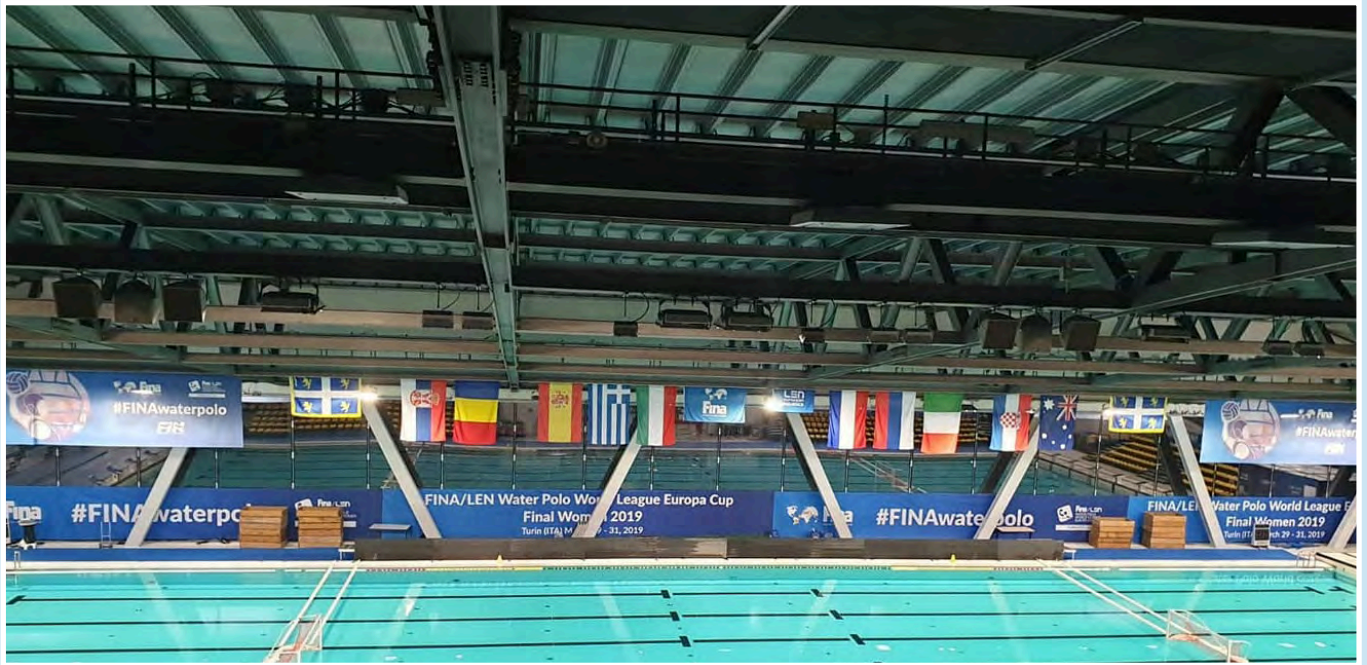
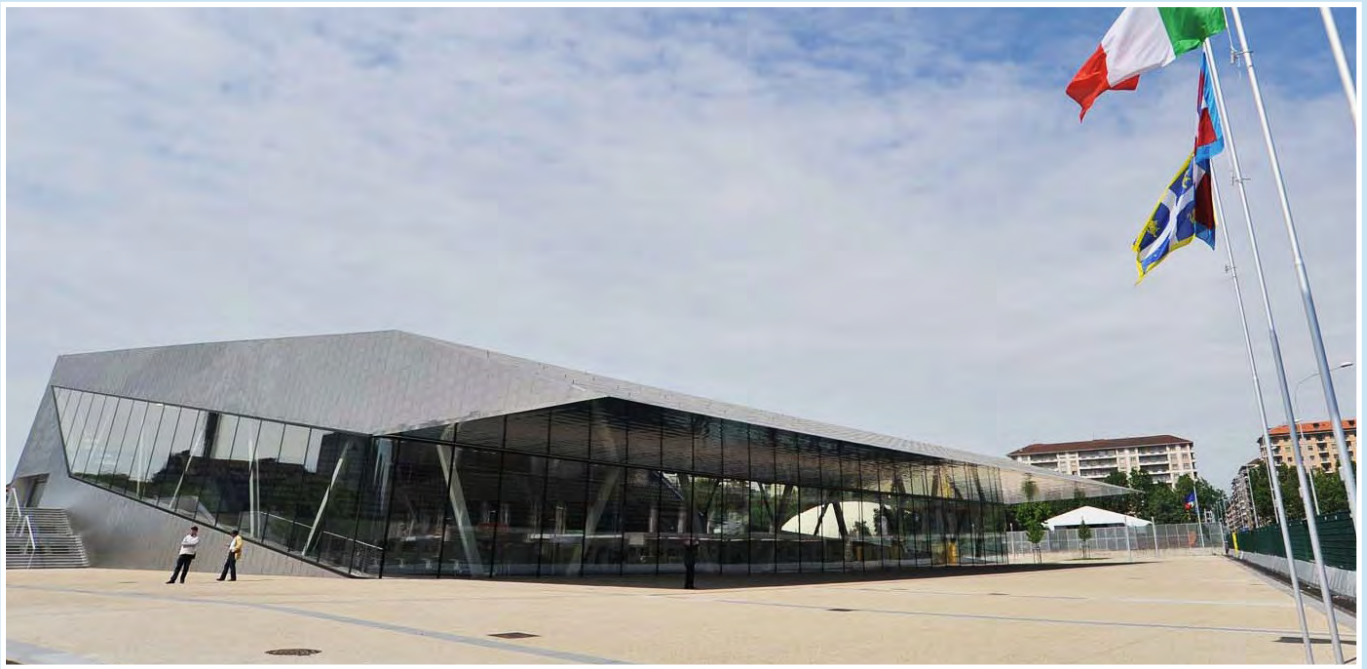
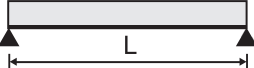
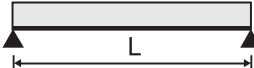
LEGENDA / INDEX	
Valori carico ammissibile uniformemente distribuito <i>Distributed load and resistance factor design</i>	Per la condizione di Stato Limite Ultimo (SLU) della lamiera / <i>Ultimate limit-state design of the corrugated sheet (SLU)</i>
	Per la condizione di Stato Limite di Esercizio (SLE) della lamiera ($F \leq L/200$; $L/400$) / <i>Serviceability limit of the corrugated sheet (SLE) ($F \leq L/200$; $L/400$)</i>

I rapporti di prova pubblicati in questo catalogo vengono forniti a titolo puramente indicativo. I dati pubblicati sono stati calcolati secondo le Norme vigenti: NTC2018, Circolare esplicativa alle NTC2018, UNI EN 1993 (EC3). Per una corretta applicazione del prodotto sarà onere e cura del cliente e/o del progettista la redazione di calcoli appropriati con specifico riferimento al singolo impiego.

The test reports published in this catalogue are provided for indicative purposes only. The published data have been calculated according to the current regulations: NTC2018, Explanatory circular to NTC2018, UNI EN 1993 (EC3). For a correct application of the product, it will be responsibility and care of the customer and/or the designer to draw up appropriate calculations with specific reference to the individual use.

TABELLA (2) DI PORTATA AMPEX: ACCIAIO S 250 GD / LOAD TABLE AMPEX: STEEL S 250 GD

I valori di portata in tabella non includono il peso proprio della lamiera grecata.
The capacity load shown in the table does not include the weight of the metal sheet itself.

		PORTATA DEL PROFILO CON FRECCIA $\leq L/200$ / SHEET CAPACITY WITH DEFLECTION $\leq L/200$ OF A SPAN																
Spessore / thickness	Carico Limite / Limit Design Deflection																	
		CARICHI MASSIMI [kg/m ²] E LUNGHEZZE IDEALI DEGLI SBALZI PER TRAVE GERBER (e) [cm]																
mm	kg/m ²	4	4,5	5	5,5	6	6,5	7	7,5	8	8,5	9	9,5	10	10,5	11	11,5	12
0,8	SLU	728	600	501	423	359	309	266	233	205	181	162	145	131	119	108	99	91
	SLE	728	600	501	423	341	269	215	175	144	120	101	86	74	64	55	48	43
	e	51	57	64	70	76	83	89	95	102	108	115	121	127	134	140	146	153
0,9	SLU	864	707	586	491	415	355	307	268	235	208	186	167	151	137	124	114	105
	SLE	864	707	586	491	397	313	250	203	168	140	118	100	86	74	64	56	50
	e	53	60	67	73	80	87	93	100	107	113	120	127	134	140	147	154	160
1,0	SLU	999	813	670	560	472	403	347	303	266	236	210	189	170	154	141	129	118
	SLE	999	813	670	560	454	357	286	233	192	160	135	114	98	85	74	65	57
	e	56	63	70	77	84	91	98	105	112	118	125	132	139	146	153	160	167
1,1	SLU	1134	918	754	626	527	449	387	338	297	263	234	210	190	172	157	144	132
	SLE	1134	918	754	626	511	402	322	262	216	180	151	129	110	95	83	73	64
	e	57	65	72	79	86	93	101	108	115	122	129	136	144	151	158	165	172
1,2	SLU	1270	1023	835	693	582	496	428	372	327	290	259	232	210	190	173	158	146
	SLE	1270	1023	835	693	568	447	358	291	240	200	168	143	123	106	92	81	71
	e	59	66	74	81	88	96	103	110	118	125	132	140	147	154	162	169	177
1,25	SLU	1338	1075	877	726	610	519	448	390	343	304	271	243	219	199	181	166	152
	SLE	1338	1075	877	726	597	470	376	306	252	210	177	150	129	111	97	85	75
	e	59	67	74	82	89	97	104	112	119	126	134	141	149	156	164	171	178
1,5	SLU	1676	1332	1080	892	750	639	551	480	422	374	333	299	270	245	223	204	187
	SLE	1676	1332	1080	892	747	587	470	382	315	263	221	188	161	139	121	106	93
	e	62	70	78	86	94	101	109	117	125	133	140	148	156	164	172	179	187

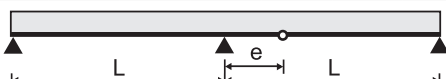
		PORTATA DEL PROFILO CON FRECCIA $\leq L/400$ / SHEET CAPACITY WITH DEFLECTION $\leq L/400$ OF A SPAN																
Spessore / thickness	Carico Limite / Limit Design Deflection																	
		CARICHI MASSIMI [kg/m ²] E LUNGHEZZE IDEALI DEGLI SBALZI PER TRAVE GERBER (e) [cm]																
mm	kg/m ²	4	4,5	5	5,5	6	6,5	7	7,5	8	8,5	9	9,5	10	10,5	11	11,5	12
0,8	SLU	728	600	501	423	359	309	266	233	205	181	162	145	131	119	108	99	91
	SLE	576	405	295	222	171	134	108	87	72	60	51	43	37	32	28	24	21
	e	51	57	64	70	76	83	89	95	102	108	115	121	127	134	140	146	153
0,9	SLU	864	707	586	491	415	355	307	268	235	208	186	167	151	137	124	114	105
	SLE	671	471	343	258	199	156	125	102	84	70	59	50	43	37	32	28	25
	e	53	60	67	73	80	87	93	100	107	113	120	127	134	140	147	154	160
1,0	SLU	999	813	670	560	472	403	347	303	266	236	210	189	170	154	141	129	118
	SLE	767	538	392	295	227	179	143	116	96	80	67	57	49	42	37	32	28
	e	56	63	70	77	84	91	98	105	112	118	125	132	139	146	153	160	167
1,1	SLU	1134	918	754	626	527	449	387	338	297	263	234	210	190	172	157	144	132
	SLE	862	606	441	332	255	201	161	131	108	90	76	64	55	48	41	36	32
	e	57	65	72	79	86	93	101	108	115	122	129	136	144	151	158	165	172
1,2	SLU	1270	1023	835	693	582	496	428	372	327	290	259	232	210	190	173	158	146
	SLE	959	673	491	369	284	223	179	145	120	100	84	72	61	53	46	40	36
	e	59	66	74	81	88	96	103	110	118	125	132	140	147	154	162	169	177
1,25	SLU	1338	1075	877	726	610	519	448	390	343	304	271	243	219	199	181	166	152
	SLE	1008	708	516	388	299	235	188	153	126	105	88	75	64	56	48	42	37
	e	59	67	74	82	89	97	104	112	119	126	134	141	149	156	164	171	178
1,5	SLU	1676	1332	1080	892	750	639	551	480	422	374	333	299	270	245	223	204	187
	SLE	1260	885	645	485	373	294	235	191	158	131	111	94	81	70	61	53	47
	e	62	70	78	86	94	101	109	117	125	133	140	148	156	164	172	179	187

LEGENDA / INDEX

Valori carico ammissibile uniformemente distribuito <i>Distributed load and resistance factor design</i>	Per la condizione di Stato Limite Ultimo (SLU) della lamiera / <i>Ultimate limit-state design of the corrugated sheet (SLU)</i>
	Per la condizione di Stato Limite di Esercizio (SLE) della lamiera ($F \leq L/200$; $L/400$) / <i>Serviceability limit of the corrugated sheet (SLE) ($F \leq L/200$; $L/400$)</i>

I rapporti di prova pubblicati in questo catalogo vengono forniti a titolo puramente indicativo. I dati pubblicati sono stati calcolati secondo le Norme vigenti: NTC2018, Circolare esplicativa alle NTC2018, UNI EN 1993 (EC3). Per una corretta applicazione del prodotto sarà onere e cura del cliente e/o del progettista la redazione di calcoli appropriati con specifico riferimento al singolo impiego.

The test reports published in this catalogue are provided for indicative purposes only. The published data have been calculated according to the current regulations: NTC2018, Explanatory circular to NTC2018, UNI EN 1993 (EC3). For a correct application of the product, it will be responsibility and care of the customer and/or the designer to draw up appropriate calculations with specific reference to the individual use.

TABELLA (3) DI PORTATA AMPEX: ACCIAIO S 250 GD / LOAD TABLE AMPEX: STEEL S 250 GD

I valori di portata in tabella non includono il peso proprio della lamiera grecata.
The capacity load shown in the table does not include the weight of the metal sheet itself.



TABELLA DI PORTATA AMPEX: ACCIAIO S 250 GD / LOAD TABLE AMPEX: STEEL S 250 GD		PORTATA DEL PROFILO CON FRECCIA $\leq L/200$ / SHEET CAPACITY WITH DEFLECTION $\leq L/200$ OF A SPAN																	
Spessore / thickness	Carico Limite / Limit Design Deflection																		
		CARICHI MASSIMI [kg/m ²] E LUNGHEZZE IDEALI DEGLI SBALZI PER TRAVE GERBER (e1) [cm]																	
mm	kg/m ²	4	4,5	5	5,5	6	6,5	7	7,5	8	8,5	9	9,5	10	10,5	11	11,5	12	
0,8	SLU	727	595	499	421	360	307	265	232	205	180	161	145	131	119	108	99	91	
	SLE	727	595	499	421	342	270	216	175	144	120	101	86	74	64	56	49	43	
	e1	60	68	76	83	90	98	106	113	120	128	136	143	150	157	166	173	180	
0,9	SLU	859	701	585	489	414	355	306	266	235	208	185	166	150	136	124	114	104	
	SLE	859	701	585	489	399	313	251	204	168	140	118	100	86	74	65	56	50	
	e1	64	72	80	88	96	103	112	120	127	135	144	152	159	167	176	183	191	
1,0	SLU	998	806	667	557	469	402	347	302	266	234	209	188	170	154	140	129	118	
	SLE	998	806	667	557	455	358	286	233	192	160	135	115	98	85	74	65	57	
	e1	67	76	85	93	101	109	118	126	134	143	152	160	168	176	185	193	201	
1,1	SLU	1130	918	750	626	525	449	385	337	295	262	234	210	190	172	157	143	132	
	SLE	1130	918	750	626	512	402	323	262	216	180	151	129	110	95	83	73	64	
	e1	70	78	88	96	105	113	123	131	140	148	157	166	174	183	192	201	209	
1,2	SLU	1266	1017	829	692	580	493	427	372	326	289	258	232	209	190	173	158	145	
	SLE	1266	1017	829	692	569	448	358	291	240	200	168	143	123	106	92	81	71	
	e1	72	81	91	99	108	117	126	135	144	153	162	171	180	188	198	207	216	
1,25	SLU	1335	1070	872	721	606	519	447	389	342	303	270	243	219	199	181	166	152	
	SLE	1335	1070	872	721	599	470	376	306	252	210	177	150	129	112	97	85	75	
	e1	73	82	92	101	110	118	128	137	146	155	165	173	182	191	201	210	219	
1,5	SLU	1665	1329	1073	890	745	637	551	478	421	372	333	299	269	245	222	204	187	
	SLE	1665	1329	1073	890	745	589	470	383	315	263	222	188	162	139	121	106	94	
	e1	78	87	98	107	117	126	136	146	155	165	175	184	194	203	214	223	233	

TABELLA DI PORTATA AMPEX: ACCIAIO S 250 GD / LOAD TABLE AMPEX: STEEL S 250 GD		PORTATA DEL PROFILO CON FRECCIA $\leq L/400$ / SHEET CAPACITY WITH DEFLECTION $\leq L/400$ OF A SPAN																	
Spessore / thickness	Carico Limite / Limit Design Deflection																		
		CARICHI MASSIMI [kg/m ²] E LUNGHEZZE IDEALI DEGLI SBALZI PER TRAVE GERBER (e1) [cm]																	
mm	kg/m ²	4	4,5	5	5,5	6	6,5	7	7,5	8	8,5	9	9,5	10	10,5	11	11,5	12	
0,8	SLU	727	595	499	421	360	307	265	232	205	180	161	145	131	119	108	99	91	
	SLE	577	407	296	222	171	135	108	88	72	60	51	43	37	32	28	24	21	
	e1	60	68	76	83	90	98	106	113	120	128	136	143	150	157	166	173	180	
0,9	SLU	859	701	585	489	414	355	306	266	235	208	185	166	150	136	124	114	104	
	SLE	673	473	344	258	199	156	125	102	84	70	59	50	43	37	32	28	25	
	e1	64	72	80	88	96	103	112	120	127	135	144	152	159	167	176	183	191	
1,0	SLU	998	806	667	557	469	402	347	302	266	234	209	188	170	154	140	129	118	
	SLE	767	541	394	296	228	179	143	116	96	80	67	57	49	42	37	32	28	
	e1	67	76	85	93	101	109	118	126	134	143	152	160	168	176	185	193	201	
1,1	SLU	1130	918	750	626	525	449	385	337	295	262	234	210	190	172	157	143	132	
	SLE	865	606	443	332	256	201	161	131	108	90	76	64	55	48	41	36	32	
	e1	70	78	88	96	105	113	123	131	140	148	157	166	174	183	192	201	209	
1,2	SLU	1266	1017	829	692	580	493	427	372	326	289	258	232	209	190	173	158	145	
	SLE	961	676	493	369	285	224	179	146	120	100	84	72	61	53	46	40	36	
	e1	72	81	91	99	108	117	126	135	144	153	162	171	180	188	198	207	216	
1,25	SLU	1335	1070	872	721	606	519	447	389	342	303	270	243	219	199	181	166	152	
	SLE	1010	710	518	389	300	235	188	153	126	105	89	75	65	56	49	42	37	
	e1	73	82	92	101	110	118	128	137	146	155	165	173	182	191	201	210	219	
1,5	SLU	1665	1329	1073	890	745	637	551	478	421	372	333	299	269	245	222	204	187	
	SLE	1265	886	648	486	375	294	235	192	158	132	111	94	81	70	61	53	47	
	e1	78	87	98	107	117	126	136	146	155	165	175	184	194	203	214	223	233	

LEGENDA / INDEX

Valori carico ammissibile uniformemente distribuito <i>Distributed load and resistance factor design</i>	>	Per la condizione di Stato Limite Ultimo (SLU) della lamiera / <i>Ultimate limit-state design of the corrugated sheet (SLU)</i>
	>	Per la condizione di Stato Limite di Esercizio (SLE) della lamiera ($F \leq L/200$; $L/400$) / <i>Serviceability limit of the corrugated sheet (SLE) ($F \leq L/200$; $L/400$)</i>

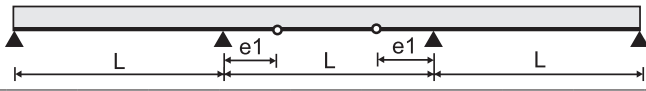
I rapporti di prova pubblicati in questo catalogo vengono forniti a titolo puramente indicativo. I dati pubblicati sono stati calcolati secondo le Norme vigenti: NTC2018, Circolare esplicativa alle NTC2018, UNI EN 1993 (EC3). Per una corretta applicazione del prodotto sarà onere e cura del cliente e/o del progettista la redazione di calcoli appropriati con specifico riferimento al singolo impiego.

The test reports published in this catalogue are provided for indicative purposes only. The published data have been calculated according to the current regulations: NTC2018, Explanatory circular to NTC2018, UNI EN 1993 (EC3). For a correct application of the product, it will be responsibility and care of the customer and/or the designer to draw up appropriate calculations with specific reference to the individual use.

TABELLA (4) DI PORTATA AMPEX: ACCIAIO S 250 GD / LOAD TABLE AMPEX: STEEL S 250 GD

I valori di portata in tabella non includono il peso proprio della lamiera grecata.
The capacity load shown in the table does not include the weight of the metal sheet itself.

TABELLA DI PORTATA AMPEX: ACCIAIO S 250 GD / LOAD TABLE AMPEX: STEEL S 250 GD																		
PORTATA DEL PROFILO CON FRECCIA $\leq L/200$ / SHEET CAPACITY WITH DEFLECTION $\leq L/200$ OF A SPAN																		
Spessore / thickness	Carico Limite Limit Design Deflection																	
		CARICHI MASSIMI [kg/m ²] E LUNGHEZZE IDEALI DEGLI SBALZI PER TRAVE GERBER (e1; e2; e3) [cm]																
mm	kg/m ²	4	4,5	5	5,5	6	6,5	7	7,5	8	8,5	9	9,5	10	10,5	11	11,5	12
0,8	SLU	727	595	498	417	357	308	264	232	205	180	161	145	130	119	108	99	91
	SLE	727	595	498	417	341	269	215	175	144	120	101	86	74	64	55	49	43
	e1	59	67	75	82	89	97	103	112	119	126	135	141	149	154	164	172	178
	e2	54	66	73	78	85	97	91	109	115	121	133	134	145	140	158	169	170
	e3	51	58	64	71	77	83	90	96	102	109	115	121	128	134	141	147	153
0,9	SLU	856	698	584	489	412	354	305	265	235	207	185	167	150	136	124	113	104
	SLE	856	698	584	489	397	313	250	203	168	140	118	100	86	74	64	56	50
	e1	62	70	77	87	95	101	108	116	126	130	143	147	153	161	174	182	190
	e2	55	65	64	84	94	93	91	101	122	109	141	129	127	137	169	178	188
	e3	54	61	67	74	81	87	94	101	107	114	121	127	134	141	147	154	161
1,0	SLU	995	810	667	558	469	401	346	301	265	235	209	188	169	154	140	128	118
	SLE	995	810	667	558	454	357	286	233	192	160	135	114	98	85	74	65	57
	e1	64	72	84	91	99	106	112	122	130	135	146	154	166	173	182	189	193
	e2	51	59	83	85	93	96	87	106	114	105	124	132	160	163	171	173	160
	e3	56	63	70	77	84	91	98	105	112	119	126	133	140	147	154	161	168
1,1	SLU	1126	914	752	618	522	446	386	337	296	261	233	210	189	172	156	143	131
	SLE	1126	914	752	618	511	402	322	262	216	180	151	129	110	95	83	73	64
	e1	66	74	83	95	102	107	116	124	133	146	153	157	165	182	190	193	204
	e2	51	58	65	91	93	84	90	97	109	140	137	123	129	181	183	164	186
	e3	58	65	72	80	87	94	101	108	115	123	130	137	144	151	159	166	173
1,2	SLU	1267	1012	830	692	577	494	427	370	326	288	257	232	208	189	173	158	145
	SLE	1267	1012	830	692	568	447	358	291	240	200	168	143	123	106	92	81	71
	e1	71	79	88	94	107	115	124	131	139	150	159	167	168	177	188	206	211
	e2	68	74	80	75	105	111	116	117	123	142	148	154	124	135	151	204	196
	e3	59	67	74	81	89	96	103	111	118	126	133	140	148	155	162	170	177
1,25	SLU	1329	1074	869	724	605	518	444	389	343	302	271	242	219	198	181	165	152
	SLE	1329	1074	869	724	597	470	376	306	252	210	177	150	129	111	97	85	75
	e1	72	78	89	99	102	115	125	128	141	151	158	168	178	190	198	204	210
	e2	69	65	80	94	75	105	114	95	125	139	135	150	164	188	189	184	180
	e3	60	67	75	82	90	97	105	112	119	127	134	142	149	157	164	172	179
1,5	SLU	1661	1317	1080	890	747	635	547	480	421	373	332	298	270	245	223	203	187
	SLE	1661	1317	1080	890	747	587	470	382	315	263	221	188	161	139	121	106	93
	e1	72	84	96	105	108	118	134	142	144	154	167	183	191	190	209	213	220
	e2	53	75	92	99	80	93	127	131	107	119	141	180	183	146	195	180	179
	e3	63	71	78	86	94	102	110	117	125	133	141	149	156	164	172	180	188

LEGENDA / INDEX

Valori carico ammissibile
uniformemente distribuito
*Distributed load
and resistance factor
design*

>

Per la condizione di Stato Limite Ultimo (SLU) della lamiera / *Ultimate limit-state design of the corrugated sheet (SLU)*

>

Per la condizione di Stato Limite di Esercizio (SLE) della lamiera ($F \leq L/200$ / *Serviceability limit of the corrugated sheet (SLE) ($F \leq L/200$)*)

I rapporti di prova pubblicati in questo catalogo vengono forniti a titolo puramente indicativo. I dati pubblicati sono stati calcolati secondo le Norme vigenti: NTC2018, Circolare esplicativa alle NTC2018, UNI EN 1993 (EC3). Per una corretta applicazione del prodotto sarà onere e cura del cliente e/o del progettista la redazione di calcoli appropriati con specifico riferimento al singolo impiego.

The test reports published in this catalogue are provided for indicative purposes only. The published data have been calculated according to the current regulations: NTC2018, Explanatory circular to NTC2018, UNI EN 1993 (EC3). For a correct application of the product, it will be responsibility and care of the customer and/or the designer to draw up appropriate calculations with specific reference to the individual use.

TABELLA (4) DI PORTATA AMPEX: ACCIAIO S 250 GD / LOAD TABLE AMPEX: STEEL S 250 GD

I valori di portata in tabella non includono il peso proprio della lamiera grecata.
The capacity load shown in the table does not include the weight of the metal sheet itself.

TABELLA DI PORTATA AMPEX: ACCIAIO S 250 GD / LOAD TABLE AMPEX: STEEL S 250 GD																		
PORTATA DEL PROFILO CON FRECCIA $\leq L/400$ / SHEET CAPACITY WITH DEFLECTION $\leq L/400$ OF A SPAN																		
Spessore / thickness	Carico Limite Limit Design Deflection																	
		CARICHI MASSIMI [kg/m ²] E LUNGHEZZE IDEALI DEGLI SBALZI PER TRAVE GERBER (e1; e2; e3) [cm]																
mm	kg/m ²	4	4,5	5	5,5	6	6,5	7	7,5	8	8,5	9	9,5	10	10,5	11	11,5	12
0,8	SLU	727	595	498	417	357	308	264	232	205	180	161	145	130	119	108	99	91
	SLE	576	405	295	222	171	134	108	87	72	60	51	43	37	32	28	24	21
	e1	59	67	75	82	89	97	103	112	119	126	135	141	149	154	164	172	178
	e2	54	66	73	78	85	97	91	109	115	121	133	134	145	140	158	169	170
	e3	51	58	64	71	77	83	90	96	102	109	115	121	128	134	141	147	153
0,9	SLU	856	698	584	489	412	354	305	265	235	207	185	167	150	136	124	113	104
	SLE	671	471	343	258	199	156	125	102	84	70	59	50	43	37	32	28	25
	e1	62	70	77	87	95	101	108	116	126	130	143	147	153	161	174	182	190
	e2	55	65	64	84	94	93	91	101	122	109	141	129	127	137	169	178	188
	e3	54	61	67	74	81	87	94	101	107	114	121	127	134	141	147	154	161
1,0	SLU	995	810	667	558	469	401	346	301	265	235	209	188	169	154	140	128	118
	SLE	767	539	392	295	227	179	143	116	96	80	67	57	49	42	37	32	28
	e1	64	72	84	91	99	106	112	122	130	135	146	154	166	173	182	189	193
	e2	51	59	83	85	93	96	87	106	114	105	124	132	160	163	171	173	160
	e3	56	63	70	77	84	91	98	105	112	119	126	133	140	147	154	161	168
1,1	SLU	1126	914	752	618	522	446	386	337	296	261	233	210	189	172	156	143	131
	SLE	863	606	441	332	255	201	161	131	108	90	76	64	55	48	41	36	32
	e1	66	74	83	95	102	107	116	124	133	146	153	157	165	182	190	193	204
	e2	51	58	65	91	93	84	90	97	109	140	137	123	129	181	183	164	186
	e3	58	65	72	80	87	94	101	108	115	123	130	137	144	151	159	166	173
1,2	SLU	1267	1012	830	692	577	494	427	370	326	288	257	232	208	189	173	158	145
	SLE	959	673	491	369	284	223	179	145	120	100	84	72	61	53	46	40	36
	e1	71	79	88	94	107	115	124	131	139	150	159	167	168	177	188	206	211
	e2	68	74	80	75	105	111	116	117	123	142	148	154	124	135	151	204	196
	e3	59	67	74	81	89	96	103	111	118	126	133	140	148	155	162	170	177
1,25	SLU	1329	1074	869	724	605	518	444	389	343	302	271	242	219	198	181	165	152
	SLE	1008	708	516	388	299	235	188	153	126	105	88	75	64	56	48	42	37
	e1	72	78	89	99	102	115	125	128	141	151	158	168	178	190	198	204	210
	e2	69	65	80	94	75	105	114	95	125	139	135	150	164	188	189	184	180
	e3	60	67	75	82	90	97	105	112	119	127	134	142	149	157	164	172	179
1,5	SLU	1661	1317	1080	890	747	635	547	480	421	373	332	298	270	245	223	203	187
	SLE	1260	885	645	485	373	294	235	191	158	131	111	94	81	70	61	53	47
	e1	72	84	96	105	108	118	134	142	144	154	167	183	191	190	209	213	220
	e2	53	75	92	99	80	93	127	131	107	119	141	180	183	146	195	180	179
	e3	63	71	78	86	94	102	110	117	125	133	141	149	156	164	172	180	188

LEGENDA / INDEX

Valori carico ammissibile uniformemente distribuito <i>Distributed load and resistance factor design</i>	>	Per la condizione di Stato Limite Ultimo (SLU) della lamiera / <i>Ultimate limit-state design of the corrugated sheet (SLU)</i>
	>	Per la condizione di Stato Limite di Esercizio (SLE) della lamiera ($F \leq L/400$) / <i>Serviceability limit of the corrugated sheet (SLE) ($F \leq L/400$)</i>

I rapporti di prova pubblicati in questo catalogo vengono forniti a titolo puramente indicativo. I dati pubblicati sono stati calcolati secondo le Norme vigenti: NTC2018, Circolare esplicativa alle NTC2018, UNI EN 1993 (EC3). Per una corretta applicazione del prodotto sarà onere e cura del cliente e/o del progettista la redazione di calcoli appropriati con specifico riferimento al singolo impiego.

The test reports published in this catalogue are provided for indicative purposes only. The published data have been calculated according to the current regulations: NTC2018, Explanatory circular to NTC2018, UNI EN 1993 (EC3). For a correct application of the product, it will be responsibility and care of the customer and/or the designer to draw up appropriate calculations with specific reference to the individual use.

TABELLA (5) DI PORTATA AMPEX: ACCIAIO S 250 GD / LOAD TABLE AMPEX: STEEL S 250 GD

I valori di portata in tabella non includono il peso proprio della lamiera grecata.
The capacity load shown in the table does not include the weight of the metal sheet itself.

Spessore / thickness		PORTATA DEL PROFILO CON FRECCIA $\leq L/200$ / SHEET CAPACITY WITH DEFLECTION $\leq L/200$ OF A SPAN																
mm	Carico Limite / Limit Design Deflection																	
		CARICHI MASSIMI [kg/m ²] E LUNGHEZZE IDEALI DEGLI SBALZI PER TRAVE GERBER (e ₁ ; e ₂ ; e ₃) [cm]																
	kg/m ²	4	4,5	5	5,5	6	6,5	7	7,5	8	8,5	9	9,5	10	10,5	11	11,5	12
0,8	SLU	727	599	501	422	359	309	266	233	205	181	162	145	131	119	108	99	91
	SLE	727	599	501	422	341	269	215	175	144	120	101	86	74	64	55	49	43
	e1	59	67	75	82	89	97	103	112	119	126	135	141	149	154	164	172	178
	e2	54	66	73	78	85	97	91	109	115	121	133	134	145	140	158	169	170
0,9	SLU	863	706	586	491	417	355	307	268	235	208	186	167	151	137	124	114	105
	SLE	863	706	586	491	397	313	250	203	168	140	118	100	86	74	64	56	50
	e1	62	70	77	87	95	101	108	116	126	130	143	147	153	161	174	182	190
	e2	55	65	64	84	94	93	91	101	122	109	141	129	127	137	169	178	188
1,0	SLU	998	812	670	560	471	403	347	303	266	236	210	189	170	154	141	129	118
	SLE	998	812	670	560	454	357	286	233	192	160	135	114	98	85	74	65	57
	e1	64	72	84	91	99	106	112	122	130	135	146	154	166	173	182	189	193
	e2	51	59	83	85	93	96	87	106	114	105	124	132	160	163	171	173	160
1,1	SLU	1.133	917	754	626	527	449	387	337	297	263	234	210	190	172	157	144	132
	SLE	1.133	917	754	626	511	402	322	262	216	180	151	129	110	95	83	73	64
	e1	66	74	83	95	102	107	116	124	133	146	153	157	165	182	190	193	204
	e2	51	58	65	91	93	84	90	97	109	140	137	123	129	181	183	164	186
1,2	SLU	1.270	1.023	835	693	582	496	428	372	327	290	259	232	210	190	173	158	145
	SLE	1.270	1.023	835	693	568	447	358	291	240	200	168	143	123	106	92	81	71
	e1	71	79	88	94	107	115	124	131	139	150	159	167	168	177	188	206	211
	e2	68	74	80	75	105	111	116	117	123	142	148	154	124	135	151	204	196
1,25	SLU	1.337	1.074	876	725	610	519	448	390	343	304	271	243	219	199	181	166	152
	SLE	1.337	1.074	876	725	597	470	376	306	252	210	177	150	129	111	97	85	75
	e1	72	78	89	99	102	115	125	128	141	151	158	168	178	190	198	204	210
	e2	69	65	80	94	75	105	114	95	125	139	135	150	164	188	189	184	180
1,5	SLU	1.675	1.332	1.080	892	750	639	551	480	422	374	333	299	270	245	223	204	187
	SLE	1.675	1.332	1.080	892	747	587	470	382	315	263	221	188	161	139	121	106	93
	e1	72	84	96	105	108	118	134	142	144	154	167	183	191	190	209	213	220
	e2	53	75	92	99	80	93	127	131	107	119	141	180	183	146	195	180	179

LEGENDA / INDEX

Valori carico ammissibile uniformemente distribuito <i>Distributed load and resistance factor design</i>	>	Per la condizione di Stato Limite Ultimo (SLU) della lamiera / <i>Ultimate limit-state design of the corrugated sheet (SLU)</i>
	>	Per la condizione di Stato Limite di Esercizio (SLE) della lamiera ($F \leq L/200$) / <i>Serviceability limit of the corrugated sheet (SLE) ($F \leq L/200$)</i>

I rapporti di prova pubblicati in questo catalogo vengono forniti a titolo puramente indicativo. I dati pubblicati sono stati calcolati secondo le Norme vigenti: NTC2018, Circolare esplicativa alle NTC2018, UNI EN 1993 (EC3). Per una corretta applicazione del prodotto sarà onere e cura del cliente e/o del progettista la redazione di calcoli appropriati con specifico riferimento al singolo impiego.

The test reports published in this catalogue are provided for indicative purposes only. The published data have been calculated according to the current regulations: NTC2018, Explanatory circular to NTC2018, UNI EN 1993 (EC3). For a correct application of the product, it will be responsibility and care of the customer and/or the designer to draw up appropriate calculations with specific reference to the individual use.

TABELLA (5) DI PORTATA AMPEX: ACCIAIO S 250 GD / LOAD TABLE AMPEX: STEEL S 250 GD

I valori di portata in tabella non includono il peso proprio della lamiera grecata.
The capacity load shown in the table does not include the weight of the metal sheet itself.

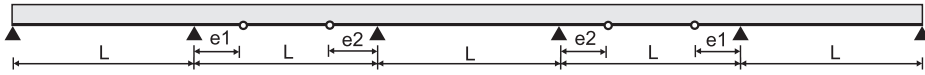
TABELLA DI PORTATA AMPEX: ACCIAIO S 250 GD / LOAD TABLE AMPEX: STEEL S 250 GD																		
PORTATA DEL PROFILO CON FRECCIA $\leq L/400$ / SHEET CAPACITY WITH DEFLECTION $\leq L/400$ OF A SPAN																		
Spessore / thickness	Carico Limite Limit Design Deflection																	
		CARICHI MASSIMI [kg/m ²] E LUNGHEZZE IDEALI DEGLI SBALZI PER TRAVE GERBER (e1; e2; e3) [cm]																
mm	kg/m ²	4	4,5	5	5,5	6	6,5	7	7,5	8	8,5	9	9,5	10	10,5	11	11,5	12
0,8	SLU	727	599	501	422	359	309	266	233	205	181	162	145	131	119	108	99	91
	SLE	576	405	295	222	171	134	108	87	72	60	51	43	37	32	28	24	21
	e1	59	67	75	82	89	97	103	112	119	126	135	141	149	154	164	172	178
	e2	54	66	73	78	85	97	91	109	115	121	133	134	145	140	158	169	170
0,9	SLU	863	706	586	491	417	355	307	268	235	208	186	167	151	137	124	114	105
	SLE	671	471	343	258	199	156	125	102	84	70	59	50	43	37	32	28	25
	e1	62	70	77	87	95	101	108	116	126	130	143	147	153	161	174	182	190
	e2	55	65	64	84	94	93	91	101	122	109	141	129	127	137	169	178	188
1,0	SLU	998	812	670	560	471	403	347	303	266	236	210	189	170	154	141	129	118
	SLE	767	539	392	295	227	179	143	116	96	80	67	57	49	42	37	32	28
	e1	64	72	84	91	99	106	112	122	130	135	146	154	166	173	182	189	193
	e2	51	59	83	85	93	96	87	106	114	105	124	132	160	163	171	173	160
1,1	SLU	1133	917	754	626	527	449	387	337	297	263	234	210	190	172	157	144	132
	SLE	863	606	441	332	255	201	161	131	108	90	76	64	55	48	41	36	32
	e1	66	74	83	95	102	107	116	124	133	146	153	157	165	182	190	193	204
	e2	51	58	65	91	93	84	90	97	109	140	137	123	129	181	183	164	186
1,2	SLU	1270	1023	835	693	582	496	428	372	327	290	259	232	210	190	173	158	145
	SLE	959	673	491	369	284	223	179	145	120	100	84	72	61	53	46	40	36
	e1	71	79	88	94	107	115	124	131	139	150	159	167	168	177	188	206	211
	e2	68	74	80	75	105	111	116	117	123	142	148	154	124	135	151	204	196
1,25	SLU	1337	1074	876	725	610	519	448	390	343	304	271	243	219	199	181	166	152
	SLE	1008	708	516	388	299	235	188	153	126	105	88	75	64	56	48	42	37
	e1	72	78	89	99	102	115	125	128	141	151	158	168	178	190	198	204	210
	e2	69	65	80	94	75	105	114	95	125	139	135	150	164	188	189	184	180
1,5	SLU	1675	1332	1080	892	750	639	551	480	422	374	333	299	270	245	223	204	187
	SLE	1260	885	645	485	373	294	235	191	158	131	111	94	81	70	61	53	47
	e1	72	84	96	105	108	118	134	142	144	154	167	183	191	190	209	213	220
	e2	53	75	92	99	80	93	127	131	107	119	141	180	183	146	195	180	179

LEGENDA / INDEX

Valori carico ammissibile uniformemente distribuito <i>Distributed load and resistance factor design</i>	>	Per la condizione di Stato Limite Ultimo (SLU) della lamiera / <i>Ultimate limit-state design of the corrugated sheet (SLU)</i>
	>	Per la condizione di Stato Limite di Esercizio (SLE) della lamiera ($F \leq L/400$ / <i>Serviceability limit of the corrugated sheet (SLE) ($F \leq L/400$)</i>

I rapporti di prova pubblicati in questo catalogo vengono forniti a titolo puramente indicativo. I dati pubblicati sono stati calcolati secondo le Norme vigenti: NTC2018, Circolare esplicativa alle NTC2018, UNI EN 1993 (EC3). Per una corretta applicazione del prodotto sarà onere e cura del cliente e/o del progettista la redazione di calcoli appropriati con specifico riferimento al singolo impiego.

The test reports published in this catalogue are provided for indicative purposes only. The published data have been calculated according to the current regulations: NTC2018, Explanatory circular to NTC2018, UNI EN 1993 (EC3). For a correct application of the product, it will be responsibility and care of the customer and/or the designer to draw up appropriate calculations with specific reference to the individual use.

TABELLA (6) DI PORTATA AMPEX: ACCIAIO S 250 GD / LOAD TABLE AMPEX: STEEL S 250 GD

I valori di portata in tabella non includono il peso proprio della lamiera grecata.
The capacity load shown in the table does not include the weight of the metal sheet itself.

Spessore / thickness		PORTATA DEL PROFILO CON FRECCIA $\leq L/200$ / SHEET CAPACITY WITH DEFLECTION $\leq L/200$ OF A SPAN																	
mm	Carico Limite / Limit Design Deflection																		
		CARICHI MASSIMI [kg/m ²] E LUNGHEZZE IDEALI DEGLI SBALZI PER TRAVE GERBER (e1; e2; e3) [cm]																	
	kg/m ²	4	4,5	5	5,5	6	6,5	7	7,5	8	8,5	9	9,5	10	10,5	11	11,5	12	
0,8	SLU	727	595	498	417	357	308	264	232	205	180	161	145	130	119	108	99	91	
	SLE	727	595	498	417	341	269	215	175	144	120	101	86	74	64	55	49	43	
	e1	59	67	75	82	89	97	103	112	119	126	135	141	149	154	164	172	178	
	e2	54	66	73	78	85	97	91	109	115	121	133	134	145	140	158	169	170	
	e3	51	58	64	71	77	83	90	96	102	109	115	121	128	134	141	147	153	
0,9	SLU	856	698	584	489	412	354	305	265	235	207	185	167	150	136	124	113	104	
	SLE	856	698	584	489	397	313	250	203	168	140	118	100	86	74	64	56	50	
	e1	62	70	77	87	95	101	108	116	126	130	143	147	153	161	174	182	190	
	e2	55	65	64	84	94	93	91	101	122	109	141	129	127	137	169	178	188	
	e3	54	61	67	74	81	87	94	101	107	114	121	127	134	141	147	154	161	
1,0	SLU	995	810	667	558	469	401	346	301	265	235	209	188	169	154	140	128	118	
	SLE	995	810	667	558	454	357	286	233	192	160	135	114	98	85	74	65	57	
	e1	64	72	84	91	99	106	112	122	130	135	146	154	166	173	182	189	193	
	e2	51	59	83	85	93	96	87	106	114	105	124	132	160	163	171	173	160	
	e3	56	63	70	77	84	91	98	105	112	119	126	133	140	147	154	161	168	
1,1	SLU	1126	914	752	618	522	446	386	337	296	261	233	210	189	172	156	143	131	
	SLE	1126	914	752	618	511	402	322	262	216	180	151	129	110	95	83	73	64	
	e1	66	74	83	95	102	107	116	124	133	146	153	157	165	182	190	193	204	
	e2	51	58	65	91	93	84	90	97	109	140	137	123	129	181	183	164	186	
	e3	58	65	72	80	87	94	101	108	115	123	130	137	144	151	159	166	173	
1,2	SLU	1267	1012	830	692	577	494	427	370	326	288	257	232	208	189	173	158	145	
	SLE	1267	1012	830	692	568	447	358	291	240	200	168	143	123	106	92	81	71	
	e1	71	79	88	94	107	115	124	131	139	150	159	167	168	177	188	206	211	
	e2	68	74	80	75	105	111	116	117	123	142	148	154	124	135	151	204	196	
	e3	59	67	74	81	89	96	103	111	118	126	133	140	148	155	162	170	177	
1,25	SLU	1329	1074	869	724	605	518	444	389	343	302	271	242	219	198	181	165	152	
	SLE	1329	1074	869	724	597	470	376	306	252	210	177	150	129	111	97	85	75	
	e1	72	78	89	99	102	115	125	128	141	151	158	168	178	190	198	204	210	
	e2	69	65	80	94	75	105	114	95	125	139	135	150	164	188	189	184	180	
	e3	60	67	75	82	90	97	105	112	119	127	134	142	149	157	164	172	179	
1,5	SLU	1661	1317	1080	890	747	635	547	480	421	373	332	298	270	245	223	203	187	
	SLE	1661	1317	1080	890	747	587	470	382	315	263	221	188	161	139	121	106	93	
	e1	72	84	96	105	108	118	134	142	144	154	167	183	191	190	209	213	220	
	e2	53	75	92	99	80	93	127	131	107	119	141	180	183	146	195	180	179	
	e3	63	71	78	86	94	102	110	117	125	133	141	149	156	164	172	180	188	

LEGENDA / INDEX

Valori carico ammissibile uniformemente distribuito
Distributed load and resistance factor design

>

Per la condizione di Stato Limite Ultimo (SLU) della lamiera / *Ultimate limit-state design of the corrugated sheet (SLU)*

>

Per la condizione di Stato Limite di Esercizio (SLE) della lamiera ($F \leq L/200$) / *Serviceability limit of the corrugated sheet (SLE) ($F \leq L/200$)*

I rapporti di prova pubblicati in questo catalogo vengono forniti a titolo puramente indicativo. I dati pubblicati sono stati calcolati secondo le Norme vigenti: NTC2018, Circolare esplicativa alle NTC2018, UNI EN 1993 (EC3). Per una corretta applicazione del prodotto sarà onere e cura del cliente e/o del progettista la redazione di calcoli appropriati con specifico riferimento al singolo impiego.

The test reports published in this catalogue are provided for indicative purposes only. The published data have been calculated according to the current regulations: NTC2018, Explanatory circular to NTC2018, UNI EN 1993 (EC3). For a correct application of the product, it will be responsibility and care of the customer and/or the designer to draw up appropriate calculations with specific reference to the individual use.

TABELLA (6) DI PORTATA AMPEX: ACCIAIO S 250 GD / LOAD TABLE AMPEX: STEEL S 250 GD

I valori di portata in tabella non includono il peso proprio della lamiera grecata.
The capacity load shown in the table does not include the weight of the metal sheet itself.

TABELLA DI PORTATA AMPEX: ACCIAIO S 250 GD / LOAD TABLE AMPEX: STEEL S 250 GD		PORTATA DEL PROFILO CON FRECCIA $\leq L/400$ / SHEET CAPACITY WITH DEFLECTION $\leq L/400$ OF A SPAN																	
Spessore / thickness	Carico Limite / Limit Design Deflection																		
		CARICHI MASSIMI [kg/m ²] E LUNGHEZZE IDEALI DEGLI SBALZI PER TRAVE GERBER (e1; e2; e3) [cm]																	
mm	kg/m ²	4	4,5	5	5,5	6	6,5	7	7,5	8	8,5	9	9,5	10	10,5	11	11,5	12	
0,8	SLU	727	595	498	417	357	308	264	232	205	180	161	145	130	119	108	99	91	
	SLE	576	405	295	222	171	134	108	87	72	60	51	43	37	32	28	24	21	
	e1	59	67	75	82	89	97	103	112	119	126	135	141	149	154	164	172	178	
	e2	54	66	73	78	85	97	91	109	115	121	133	134	145	140	158	169	170	
	e3	51	58	64	71	77	83	90	96	102	109	115	121	128	134	141	147	153	
0,9	SLU	856	698	584	489	412	354	305	265	235	207	185	167	150	136	124	113	104	
	SLE	671	471	343	258	199	156	125	102	84	70	59	50	43	37	32	28	25	
	e1	62	70	77	87	95	101	108	116	126	130	143	147	153	161	174	182	190	
	e2	55	65	64	84	94	93	91	101	122	109	141	129	127	137	169	178	188	
	e3	54	61	67	74	81	87	94	101	107	114	121	127	134	141	147	154	161	
1,0	SLU	995	810	667	558	469	401	346	301	265	235	209	188	169	154	140	128	118	
	SLE	767	539	392	295	227	179	143	116	96	80	67	57	49	42	37	32	28	
	e1	64	72	84	91	99	106	112	122	130	135	146	154	166	173	182	189	193	
	e2	51	59	83	85	93	96	87	106	114	105	124	132	160	163	171	173	160	
	e3	56	63	70	77	84	91	98	105	112	119	126	133	140	147	154	161	168	
1,1	SLU	1126	914	752	618	522	446	386	337	296	261	233	210	189	172	156	143	131	
	SLE	863	606	441	332	255	201	161	131	108	90	76	64	55	48	41	36	32	
	e1	66	74	83	95	102	107	116	124	133	146	153	157	165	182	190	193	204	
	e2	51	58	65	91	93	84	90	97	109	140	137	123	129	181	183	164	186	
	e3	58	65	72	80	87	94	101	108	115	123	130	137	144	151	159	166	173	
1,2	SLU	1267	1012	830	692	577	494	427	370	326	288	257	232	208	189	173	158	145	
	SLE	959	673	491	369	284	223	179	145	120	100	84	72	61	53	46	40	36	
	e1	71	79	88	94	107	115	124	131	139	150	159	167	168	177	188	206	211	
	e2	68	74	80	75	105	111	116	117	123	142	148	154	124	135	151	204	196	
	e3	59	67	74	81	89	96	103	111	118	126	133	140	148	155	162	170	177	
1,25	SLU	1329	1074	869	724	605	518	444	389	343	302	271	242	219	198	181	165	152	
	SLE	1008	708	516	388	299	235	188	153	126	105	88	75	64	56	48	42	37	
	e1	72	78	89	99	102	115	125	128	141	151	158	168	178	190	198	204	210	
	e2	69	65	80	94	75	105	114	95	125	139	135	150	164	188	189	184	180	
	e3	60	67	75	82	90	97	105	112	119	127	134	142	149	157	164	172	179	
1,5	SLU	1661	1317	1080	890	747	635	547	480	421	373	332	298	270	245	223	203	187	
	SLE	1260	885	645	485	373	294	235	191	158	131	111	94	81	70	61	53	47	
	e1	72	84	96	105	108	118	134	142	144	154	167	183	191	190	209	213	220	
	e2	53	75	92	99	80	93	127	131	107	119	141	180	183	146	195	180	179	
	e3	63	71	78	86	94	102	110	117	125	133	141	149	156	164	172	180	188	

LEGENDA / INDEX

Valori carico ammissibile uniformemente distribuito <i>Distributed load and resistance factor design</i>	>	Per la condizione di Stato Limite Ultimo (SLU) della lamiera / <i>Ultimate limit-state design of the corrugated sheet (SLU)</i>
	>	Per la condizione di Stato Limite di Esercizio (SLE) della lamiera ($F \leq L/400$) / <i>Serviceability limit of the corrugated sheet (SLE) ($F \leq L/400$)</i>

I rapporti di prova pubblicati in questo catalogo vengono forniti a titolo puramente indicativo. I dati pubblicati sono stati calcolati secondo le Norme vigenti: NTC2018, Circolare esplicativa alle NTC2018, UNI EN 1993 (EC3). Per una corretta applicazione del prodotto sarà onere e cura del cliente e/o del progettista la redazione di calcoli appropriati con specifico riferimento al singolo impiego.

The test reports published in this catalogue are provided for indicative purposes only. The published data have been calculated according to the current regulations: NTC2018, Explanatory circular to NTC2018, UNI EN 1993 (EC3). For a correct application of the product, it will be responsibility and care of the customer and/or the designer to draw up appropriate calculations with specific reference to the individual use.

TABELLA (7) DI PORTATA AMPEX: ACCIAIO S 250 GD / LOAD TABLE AMPEX: STEEL S 250 GD

I valori di portata in tabella non includono il peso proprio della lamiera grecata.
The capacity load shown in the table does not include the weight of the metal sheet itself.

TABELLA DI PORTATA AMPEX: ACCIAIO S 250 GD / LOAD TABLE AMPEX: STEEL S 250 GD		PORTATA DEL PROFILO CON FRECCIA $\leq L/200$ / SHEET CAPACITY WITH DEFLECTION $\leq L/200$ OF A SPAN																	
Spessore / thickness	Carico Limite Design Deflection																		
		CARICHI MASSIMI [kg/m ²] E LUNGHEZZE IDEALI DEGLI SBALZI PER TRAVE GERBER (e1; e2; e3) [cm]																	
mm	kg/m ²	4	4,5	5	5,5	6	6,5	7	7,5	8	8,5	9	9,5	10	10,5	11	11,5	12	
0,8	SLU	727	599	501	422	359	309	266	233	205	181	162	145	131	119	108	99	91	
	SLE	727	599	501	422	341	269	215	175	144	120	101	86	74	64	55	49	43	
	e1	59	67	75	82	89	97	103	112	119	126	135	141	149	154	164	172	178	
	e2	54	66	73	78	85	97	91	109	115	121	133	134	145	140	158	169	170	
0,9	SLU	863	706	586	491	417	355	307	268	235	208	186	167	151	137	124	114	105	
	SLE	863	706	586	491	397	313	250	203	168	140	118	100	86	74	64	56	50	
	e1	62	70	77	87	95	101	108	116	126	130	143	147	153	161	174	182	190	
	e2	55	65	64	84	94	93	91	101	122	109	141	129	127	137	169	178	188	
1,0	SLU	998	812	670	560	471	403	347	303	266	236	210	189	170	154	141	129	118	
	SLE	998	812	670	560	454	357	286	233	192	160	135	114	98	85	74	65	57	
	e1	64	72	84	91	99	106	112	122	130	135	146	154	166	173	182	189	193	
	e2	51	59	83	85	93	96	87	106	114	105	124	132	160	163	171	173	160	
1,1	SLU	1133	917	754	626	527	449	387	337	297	263	234	210	190	172	157	144	132	
	SLE	1133	917	754	626	511	402	322	262	216	180	151	129	110	95	83	73	64	
	e1	66	74	83	95	102	107	116	124	133	146	153	157	165	182	190	193	204	
	e2	51	58	65	91	93	84	90	97	109	140	137	123	129	181	183	164	186	
1,2	SLU	1270	1023	835	693	582	496	428	372	327	290	259	232	210	190	173	158	145	
	SLE	1270	1023	835	693	568	447	358	291	240	200	168	143	123	106	92	81	71	
	e1	71	79	88	94	107	115	124	131	139	150	159	167	168	177	188	206	211	
	e2	68	74	80	75	105	111	116	117	123	142	148	154	124	135	151	204	196	
1,25	SLU	1337	1074	876	725	610	519	448	390	343	304	271	243	219	199	181	166	152	
	SLE	1337	1074	876	725	597	470	376	306	252	210	177	150	129	111	97	85	75	
	e1	72	78	89	99	102	115	125	128	141	151	158	168	178	190	198	204	210	
	e2	69	65	80	94	75	105	114	95	125	139	135	150	164	188	189	184	180	
1,5	SLU	1675	1332	1080	892	750	639	551	480	422	374	333	299	270	245	223	204	187	
	SLE	1675	1332	1080	892	747	587	470	382	315	263	221	188	161	139	121	106	93	
	e1	72	84	96	105	108	118	134	142	144	154	167	183	191	190	209	213	220	
	e2	53	75	92	99	80	93	127	131	107	119	141	180	183	146	195	180	179	

LEGENDA / INDEX

Valori carico ammissibile uniformemente distribuito <i>Distributed load and resistance factor design</i>	>	Per la condizione di Stato Limite Ultimo (SLU) della lamiera / <i>Ultimate limit-state design of the corrugated sheet (SLU)</i>
	>	Per la condizione di Stato Limite di Esercizio (SLE) della lamiera ($F \leq L/200$) / <i>Serviceability limit of the corrugated sheet (SLE) ($F \leq L/200$)</i>

I rapporti di prova pubblicati in questo catalogo vengono forniti a titolo puramente indicativo. I dati pubblicati sono stati calcolati secondo le Norme vigenti: NTC2018, Circolare esplicativa alle NTC2018, UNI EN 1993 (EC3). Per una corretta applicazione del prodotto sarà onere e cura del cliente e/o del progettista la redazione di calcoli appropriati con specifico riferimento al singolo impiego.

The test reports published in this catalogue are provided for indicative purposes only. The published data have been calculated according to the current regulations: NTC2018, Explanatory circular to NTC2018, UNI EN 1993 (EC3). For a correct application of the product, it will be responsibility and care of the customer and/or the designer to draw up appropriate calculations with specific reference to the individual use.

TABELLA (7) DI PORTATA AMPEX: ACCIAIO S 250 GD / LOAD TABLE AMPEX: STEEL S 250 GD

I valori di portata in tabella non includono il peso proprio della lamiera grecata.
The capacity load shown in the table does not include the weight of the metal sheet itself.

TABELLA DI PORTATA AMPEX: ACCIAIO S 250 GD / LOAD TABLE AMPEX: STEEL S 250 GD		PORTATA DEL PROFILO CON FRECCIA $\leq L/400$ / SHEET CAPACITY WITH DEFLECTION $\leq L/400$ OF A SPAN																	
Spessore / thickness	Carico Limite Limit Design Deflection																		
		CARICHI MASSIMI [kg/m ²] E LUNGHEZZE IDEALI DEGLI SBALZI PER TRAVE GERBER (e1; e2; e3) [cm]																	
mm	kg/m ²	4	4,5	5	5,5	6	6,5	7	7,5	8	8,5	9	9,5	10	10,5	11	11,5	12	
0,8	SLU	727	599	501	422	359	309	266	233	205	181	162	145	131	119	108	99	91	
	SLE	576	405	295	222	171	134	108	87	72	60	51	43	37	32	28	24	21	
	e1	59	67	75	82	89	97	103	112	119	126	135	141	149	154	164	172	178	
	e2	54	66	73	78	85	97	91	109	115	121	133	134	145	140	158	169	170	
0,9	SLU	863	706	586	491	417	355	307	268	235	208	186	167	151	137	124	114	105	
	SLE	671	471	343	258	199	156	125	102	84	70	59	50	43	37	32	28	25	
	e1	62	70	77	87	95	101	108	116	126	130	143	147	153	161	174	182	190	
	e2	55	65	64	84	94	93	91	101	122	109	141	129	127	137	169	178	188	
1,0	SLU	998	812	670	560	471	403	347	303	266	236	210	189	170	154	141	129	118	
	SLE	767	539	392	295	227	179	143	116	96	80	67	57	49	42	37	32	28	
	e1	64	72	84	91	99	106	112	122	130	135	146	154	166	173	182	189	193	
	e2	51	59	83	85	93	96	87	106	114	105	124	132	160	163	171	173	160	
1,1	SLU	1133	917	754	626	527	449	387	337	297	263	234	210	190	172	157	144	132	
	SLE	863	606	441	332	255	201	161	131	108	90	76	64	55	48	41	36	32	
	e1	66	74	83	95	102	107	116	124	133	146	153	157	165	182	190	193	204	
	e2	51	58	65	91	93	84	90	97	109	140	137	123	129	181	183	164	186	
1,2	SLU	1270	1023	835	693	582	496	428	372	327	290	259	232	210	190	173	158	145	
	SLE	959	673	491	369	284	223	179	145	120	100	84	72	61	53	46	40	36	
	e1	71	79	88	94	107	115	124	131	139	150	159	167	168	177	188	206	211	
	e2	68	74	80	75	105	111	116	117	123	142	148	154	124	135	151	204	196	
1,25	SLU	1337	1074	876	725	610	519	448	390	343	304	271	243	219	199	181	166	152	
	SLE	1008	708	516	388	299	235	188	153	126	105	88	75	64	56	48	42	37	
	e1	72	78	89	99	102	115	125	128	141	151	158	168	178	190	198	204	210	
	e2	69	65	80	94	75	105	114	95	125	139	135	150	164	188	189	184	180	
1,5	SLU	1675	1332	1080	892	750	639	551	480	422	374	333	299	270	245	223	204	187	
	SLE	1260	885	645	485	373	294	235	191	158	131	111	94	81	70	61	53	47	
	e1	72	84	96	105	108	118	134	142	144	154	167	183	191	190	209	213	220	
	e2	53	75	92	99	80	93	127	131	107	119	141	180	183	146	195	180	179	
LEGENDA / INDEX																			
Valori carico ammissibile uniformemente distribuito <i>Distributed load and resistance factor design</i>	>	Per la condizione di Stato Limite Ultimo (SLU) della lamiera / <i>Ultimate limit-state design of the corrugated sheet (SLU)</i>																	
	>	Per la condizione di Stato Limite di Esercizio (SLE) della lamiera ($F \leq L/400$) / <i>Serviceability limit of the corrugated sheet (SLE) ($F \leq L/400$)</i>																	

I rapporti di prova pubblicati in questo catalogo vengono forniti a titolo puramente indicativo. I dati pubblicati sono stati calcolati secondo le Norme vigenti: NTC2018, Circolare esplicativa alle NTC2018, UNI EN 1993 (EC3). Per una corretta applicazione del prodotto sarà onere e cura del cliente e/o del progettista la redazione di calcoli appropriati con specifico riferimento al singolo impiego.

The test reports published in this catalogue are provided for indicative purposes only. The published data have been calculated according to the current regulations: NTC2018, Explanatory circular to NTC2018, UNI EN 1993 (EC3). For a correct application of the product, it will be responsibility and care of the customer and/or the designer to draw up appropriate calculations with specific reference to the individual use.

TABELLA (8) DI PORTATA AMPEX: ACCIAIO S 250 GD / LOAD TABLE AMPEX: STEEL S 250 GD

I valori di portata in tabella non includono il peso proprio della lamiera grecata.
The capacity load shown in the table does not include the weight of the metal sheet itself.

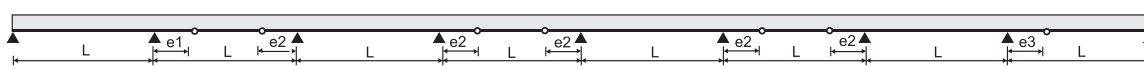
TABELLA DI PORTATA AMPEX: ACCIAIO S 250 GD / LOAD TABLE AMPEX: STEEL S 250 GD		PORTATA DEL PROFILO CON FRECCIA $\leq L/200$ / SHEET CAPACITY WITH DEFLECTION $\leq L/200$ OF A SPAN																	
Spessore / thickness	Carico Limite / Limit Design Deflection																		
		CARICHI MASSIMI [kg/m ²] E LUNGHEZZE IDEALI DEGLI SBALZI PER TRAVE GERBER (e1; e2; e3) [cm]																	
mm	kg/m ²	4	4,5	5	5,5	6	6,5	7	7,5	8	8,5	9	9,5	10	10,5	11	11,5	12	
0,8	SLU	727	595	498	417	357	308	264	232	205	180	161	145	130	119	108	99	91	
	SLE	727	595	498	417	341	269	215	175	144	120	101	86	74	64	55	49	43	
	e1	59	67	75	82	89	97	103	112	119	126	135	141	149	154	164	172	178	
	e2	54	66	73	78	85	97	91	109	115	121	133	134	145	140	158	169	170	
	e3	51	58	64	71	77	83	90	96	102	109	115	121	128	134	141	147	153	
0,9	SLU	856	698	584	489	412	354	305	265	235	207	185	167	150	136	124	113	104	
	SLE	856	698	584	489	397	313	250	203	168	140	118	100	86	74	64	56	50	
	e1	62	70	77	87	95	101	108	116	126	130	143	147	153	161	174	182	190	
	e2	55	65	64	84	94	93	91	101	122	109	141	129	127	137	169	178	188	
	e3	54	61	67	74	81	87	94	101	107	114	121	127	134	141	147	154	161	
1,0	SLU	995	810	667	558	469	401	346	301	265	235	209	188	169	154	140	128	118	
	SLE	995	810	667	558	454	357	286	233	192	160	135	114	98	85	74	65	57	
	e1	64	72	84	91	99	106	112	122	130	135	146	154	166	173	182	189	193	
	e2	51	59	83	85	93	96	87	106	114	105	124	132	160	163	171	173	160	
	e3	56	63	70	77	84	91	98	105	112	119	126	133	140	147	154	161	168	
1,1	SLU	1126	914	752	618	522	446	386	337	296	261	233	210	189	172	156	143	131	
	SLE	1126	914	752	618	511	402	322	262	216	180	151	129	110	95	83	73	64	
	e1	66	74	83	95	102	107	116	124	133	146	153	157	165	182	190	193	204	
	e2	51	58	65	91	93	84	90	97	109	140	137	123	129	181	183	164	186	
	e3	58	65	72	80	87	94	101	108	115	123	130	137	144	151	159	166	173	
1,2	SLU	1267	1012	830	692	577	494	427	370	326	288	257	232	208	189	173	158	145	
	SLE	1267	1012	830	692	568	447	358	291	240	200	168	143	123	106	92	81	71	
	e1	71	79	88	94	107	115	124	131	139	150	159	167	168	177	188	206	211	
	e2	68	74	80	75	105	111	116	117	123	142	148	154	124	135	151	204	196	
	e3	59	67	74	81	89	96	103	111	118	126	133	140	148	155	162	170	177	
1,25	SLU	1329	1074	869	724	605	518	444	389	343	302	271	242	219	198	181	165	152	
	SLE	1329	1074	869	724	597	470	376	306	252	210	177	150	129	111	97	85	75	
	e1	72	78	89	99	102	115	125	128	141	151	158	168	178	190	198	204	210	
	e2	69	65	80	94	75	105	114	95	125	139	135	150	164	188	189	184	180	
	e3	60	67	75	82	90	97	105	112	119	127	134	142	149	157	164	172	179	
1,5	SLU	1661	1317	1080	890	747	635	547	480	421	373	332	298	270	245	223	203	187	
	SLE	1661	1317	1080	890	747	587	470	382	315	263	221	188	161	139	121	106	93	
	e1	72	84	96	105	108	118	134	142	144	154	167	183	191	190	209	213	220	
	e2	53	75	92	99	80	93	127	131	107	119	141	180	183	146	195	180	179	
	e3	63	71	78	86	94	102	110	117	125	133	141	149	156	164	172	180	188	
LEGENDA / INDEX																			
Valori carico ammissibile uniformemente distribuito <i>Distributed load and resistance factor design</i>	>	Per la condizione di Stato Limite Ultimo (SLU) della lamiera / <i>Ultimate limit-state design of the corrugated sheet (SLU)</i>																	
	>	Per la condizione di Stato Limite di Esercizio (SLE) della lamiera ($F \leq L/200$) / <i>Serviceability limit of the corrugated sheet (SLE) ($F \leq L/200$)</i>																	

SISTEMA AMPEX
AMPEX SYSTEM

I rapporti di prova pubblicati in questo catalogo vengono forniti a titolo puramente indicativo. I dati pubblicati sono stati calcolati secondo le Norme vigenti: NTC2018, Circolare esplicativa alle NTC2018, UNI EN 1993 (EC3). Per una corretta applicazione del prodotto sarà onere e cura del cliente e/o del progettista la redazione di calcoli appropriati con specifico riferimento al singolo impiego.

The test reports published in this catalogue are provided for indicative purposes only. The published data have been calculated according to the current regulations: NTC2018, Explanatory circular to NTC2018, UNI EN 1993 (EC3). For a correct application of the product, it will be responsibility and care of the customer and/or the designer to draw up appropriate calculations with specific reference to the individual use.

TABELLA (8) DI PORTATA AMPEX: ACCIAIO S 250 GD / LOAD TABLE AMPEX: STEEL S 250 GD

I valori di portata in tabella non includono il peso proprio della lamiera grecata.
The capacity load shown in the table does not include the weight of the metal sheet itself.

TABELLA DI PORTATA AMPEX: ACCIAIO S 250 GD / LOAD TABLE AMPEX: STEEL S 250 GD		PORTATA DEL PROFILO CON FRECCIA $\leq L/400$ / SHEET CAPACITY WITH DEFLECTION $\leq L/400$ OF A SPAN																	
Spessore / thickness	Carico Limite Limit Design Deflection																		
		CARICHI MASSIMI [kg/m2] E LUNGHEZZE IDEALI DEGLI SBALZI PER TRAVE GERBER (e1; e2; e3) [cm]																	
mm	kg/m2	4	4,5	5	5,5	6	6,5	7	7,5	8	8,5	9	9,5	10	10,5	11	11,5	12	
0,8	SLU	727	595	498	417	357	308	264	232	205	180	161	145	130	119	108	99	91	
	SLE	576	405	295	222	171	134	108	87	72	60	51	43	37	32	28	24	21	
	e1	59	67	75	82	89	97	103	112	119	126	135	141	149	154	164	172	178	
	e2	54	66	73	78	85	97	91	109	115	121	133	134	145	140	158	169	170	
	e3	51	58	64	71	77	83	90	96	102	109	115	121	128	134	141	147	153	
0,9	SLU	856	698	584	489	412	354	305	265	235	207	185	167	150	136	124	113	104	
	SLE	671	471	343	258	199	156	125	102	84	70	59	50	43	37	32	28	25	
	e1	62	70	77	87	95	101	108	116	126	130	143	147	153	161	174	182	190	
	e2	55	65	64	84	94	93	91	101	122	109	141	129	127	137	169	178	188	
	e3	54	61	67	74	81	87	94	101	107	114	121	127	134	141	147	154	161	
1,0	SLU	995	810	667	558	469	401	346	301	265	235	209	188	169	154	140	128	118	
	SLE	767	539	392	295	227	179	143	116	96	80	67	57	49	42	37	32	28	
	e1	64	72	84	91	99	106	112	122	130	135	146	154	166	173	182	189	193	
	e2	51	59	83	85	93	96	87	106	114	105	124	132	160	163	171	173	160	
	e3	56	63	70	77	84	91	98	105	112	119	126	133	140	147	154	161	168	
1,1	SLU	1126	914	752	618	522	446	386	337	296	261	233	210	189	172	156	143	131	
	SLE	863	606	441	332	255	201	161	131	108	90	76	64	55	48	41	36	32	
	e1	66	74	83	95	102	107	116	124	133	146	153	157	165	182	190	193	204	
	e2	51	58	65	91	93	84	90	97	109	140	137	123	129	181	183	164	186	
	e3	58	65	72	80	87	94	101	108	115	123	130	137	144	151	159	166	173	
1,2	SLU	1267	1012	830	692	577	494	427	370	326	288	257	232	208	189	173	158	145	
	SLE	959	673	491	369	284	223	179	145	120	100	84	72	61	53	46	40	36	
	e1	71	79	88	94	107	115	124	131	139	150	159	167	168	177	188	206	211	
	e2	68	74	80	75	105	111	116	117	123	142	148	154	124	135	151	204	196	
	e3	59	67	74	81	89	96	103	111	118	126	133	140	148	155	162	170	177	
1,25	SLU	1329	1074	869	724	605	518	444	389	343	302	271	242	219	198	181	165	152	
	SLE	1008	708	516	388	299	235	188	153	126	105	88	75	64	56	48	42	37	
	e1	72	78	89	99	102	115	125	128	141	151	158	168	178	190	198	204	210	
	e2	69	65	80	94	75	105	114	95	125	139	135	150	164	188	189	184	180	
	e3	60	67	75	82	90	97	105	112	119	127	134	142	149	157	164	172	179	
1,5	SLU	1661	1317	1080	890	747	635	547	480	421	373	332	298	270	245	223	203	187	
	SLE	1260	885	645	485	373	294	235	191	158	131	111	94	81	70	61	53	47	
	e1	72	84	96	105	108	118	134	142	144	154	167	183	191	190	209	213	220	
	e2	53	75	92	99	80	93	127	131	107	119	141	180	183	146	195	180	179	
	e3	63	71	78	86	94	102	110	117	125	133	141	149	156	164	172	180	188	

LEGENDA / INDEX		
Valori carico ammissibile uniformemente distribuito <i>Distributed load and resistance factor design</i>	>	Per la condizione di Stato Limite Ultimo (SLU) della lamiera / <i>Ultimate limit-state design of the corrugated sheet (SLU)</i>
	>	Per la condizione di Stato Limite di Esercizio (SLE) della lamiera ($F \leq L/400$) / <i>Serviceability limit of the corrugated sheet (SLE) ($F \leq L/400$)</i>

I rapporti di prova pubblicati in questo catalogo vengono forniti a titolo puramente indicativo. I dati pubblicati sono stati calcolati secondo le Norme vigenti: NTC2018, Circolare esplicativa alle NTC2018, UNI EN 1993 (EC3). Per una corretta applicazione del prodotto sarà onere e cura del cliente e/o del progettista la redazione di calcoli appropriati con specifico riferimento al singolo impiego.

The test reports published in this catalogue are provided for indicative purposes only. The published data have been calculated according to the current regulations: NTC2018, Explanatory circular to NTC2018, UNI EN 1993 (EC3). For a correct application of the product, it will be responsibility and care of the customer and/or the designer to draw up appropriate calculations with specific reference to the individual use.

TABELLA (9) DI PORTATA AMPEX: ACCIAIO S 250 GD / LOAD TABLE AMPEX: STEEL S 250 GD

I valori di portata in tabella non includono il peso proprio della lamiera grecata.
The capacity load shown in the table does not include the weight of the metal sheet itself.

TABELLA DI PORTATA AMPEX: ACCIAIO S 250 GD / LOAD TABLE AMPEX: STEEL S 250 GD		PORTATA DEL PROFILO CON FRECCIA $\leq L/200$ / SHEET CAPACITY WITH DEFLECTION $\leq L/200$ OF A SPAN																	
Spessore / thickness	Carico Limite Limit Design Deflection																		
		CARICHI MASSIMI [kg/m ²] E LUNGHEZZE IDEALI DEGLI SBALZI PER TRAVE GERBER (e1; e2; e3) [cm]																	
mm	kg/m ²	4	4,5	5	5,5	6	6,5	7	7,5	8	8,5	9	9,5	10	10,5	11	11,5	12	
0,8	SLU	727	599	501	422	359	309	266	233	205	181	162	145	131	119	108	99	91	
	SLE	727	599	501	422	341	269	215	175	144	120	101	86	74	64	55	49	43	
	e1	59	67	75	82	89	97	103	112	119	126	135	141	149	154	164	172	178	
	e2	54	66	73	78	85	97	91	109	115	121	133	134	145	140	158	169	170	
0,9	SLU	863	706	586	491	417	355	307	268	235	208	186	167	151	137	124	114	105	
	SLE	863	706	586	491	397	313	250	203	168	140	118	100	86	74	64	56	50	
	e1	62	70	77	87	95	101	108	116	126	130	143	147	153	161	174	182	190	
	e2	55	65	64	84	94	93	91	101	122	109	141	129	127	137	169	178	188	
1,0	SLU	998	812	670	560	471	403	347	303	266	236	210	189	170	154	141	129	118	
	SLE	998	812	670	560	454	357	286	233	192	160	135	114	98	85	74	65	57	
	e1	64	72	84	91	99	106	112	122	130	135	146	154	166	173	182	189	193	
	e2	51	59	83	85	93	96	87	106	114	105	124	132	160	163	171	173	160	
1,1	SLU	1133	917	754	626	527	449	387	337	297	263	234	210	190	172	157	144	132	
	SLE	1133	917	754	626	511	402	322	262	216	180	151	129	110	95	83	73	64	
	e1	66	74	83	95	102	107	116	124	133	146	153	157	165	182	190	193	204	
	e2	51	58	65	91	93	84	90	97	109	140	137	123	129	181	183	164	186	
1,2	SLU	1270	1023	835	693	582	496	428	372	327	290	259	232	210	190	173	158	145	
	SLE	1270	1023	835	693	568	447	358	291	240	200	168	143	123	106	92	81	71	
	e1	71	79	88	94	107	115	124	131	139	150	159	167	168	177	188	206	211	
	e2	68	74	80	75	105	111	116	117	123	142	148	154	124	135	151	204	196	
1,25	SLU	1337	1074	876	725	610	519	448	390	343	304	271	243	219	199	181	166	152	
	SLE	1337	1074	876	725	597	470	376	306	252	210	177	150	129	111	97	85	75	
	e1	72	78	89	99	102	115	125	128	141	151	158	168	178	190	198	204	210	
	e2	69	65	80	94	75	105	114	95	125	139	135	150	164	188	189	184	180	
1,5	SLU	1675	1332	1080	892	750	639	551	480	422	374	333	299	270	245	223	204	187	
	SLE	1675	1332	1080	892	747	587	470	382	315	263	221	188	161	139	121	106	93	
	e1	72	84	96	105	108	118	134	142	144	154	167	183	191	190	209	213	220	
	e2	53	75	92	99	80	93	127	131	107	119	141	180	183	146	195	180	179	

LEGENDA / INDEX

Valori carico ammissibile uniformemente distribuito <i>Distributed load and resistance factor design</i>	>	Per la condizione di Stato Limite Ultimo (SLU) della lamiera / <i>Ultimate limit-state design of the corrugated sheet (SLU)</i>
	>	Per la condizione di Stato Limite di Esercizio (SLE) della lamiera ($F \leq L/200$) / <i>Serviceability limit of the corrugated sheet (SLE) ($F \leq L/200$)</i>

I rapporti di prova pubblicati in questo catalogo vengono forniti a titolo puramente indicativo. I dati pubblicati sono stati calcolati secondo le Norme vigenti: NTC2018, Circolare esplicativa alle NTC2018, UNI EN 1993 (EC3). Per una corretta applicazione del prodotto sarà onere e cura del cliente e/o del progettista la redazione di calcoli appropriati con specifico riferimento al singolo impiego.

The test reports published in this catalogue are provided for indicative purposes only. The published data have been calculated according to the current regulations: NTC2018, Explanatory circular to NTC2018, UNI EN 1993 (EC3). For a correct application of the product, it will be responsibility and care of the customer and/or the designer to draw up appropriate calculations with specific reference to the individual use.

TABELLA (9) DI PORTATA AMPEX: ACCIAIO S 250 GD / LOAD TABLE AMPEX: STEEL S 250 GD

I valori di portata in tabella non includono il peso proprio della lamiera grecata.
The capacity load shown in the table does not include the weight of the metal sheet itself.

TABELLA DI PORTATA AMPEX: ACCIAIO S 250 GD / LOAD TABLE AMPEX: STEEL S 250 GD		PORTATA DEL PROFILO CON FRECCIA $\leq L/400$ / SHEET CAPACITY WITH DEFLECTION $\leq L/400$ OF A SPAN																	
Spessore / thickness	Carico Limite Limit Design Deflection																		
		CARICHI MASSIMI [kg/m ²] E LUNGHEZZE IDEALI DEGLI SBALZI PER TRAVE GERBER (e1; e2; e3) [cm]																	
mm	kg/m ²	4	4,5	5	5,5	6	6,5	7	7,5	8	8,5	9	9,5	10	10,5	11	11,5	12	
0,8	SLU	727	599	501	422	359	309	266	233	205	181	162	145	131	119	108	99	91	
	SLE	576	405	295	222	171	134	108	87	72	60	51	43	37	32	28	24	21	
	e1	59	67	75	82	89	97	103	112	119	126	135	141	149	154	164	172	178	
	e2	54	66	73	78	85	97	91	109	115	121	133	134	145	140	158	169	170	
0,9	SLU	863	706	586	491	417	355	307	268	235	208	186	167	151	137	124	114	105	
	SLE	671	471	343	258	199	156	125	102	84	70	59	50	43	37	32	28	25	
	e1	62	70	77	87	95	101	108	116	126	130	143	147	153	161	174	182	190	
	e2	55	65	64	84	94	93	91	101	122	109	141	129	127	137	169	178	188	
1,0	SLU	998	812	670	560	471	403	347	303	266	236	210	189	170	154	141	129	118	
	SLE	767	539	392	295	227	179	143	116	96	80	67	57	49	42	37	32	28	
	e1	64	72	84	91	99	106	112	122	130	135	146	154	166	173	182	189	193	
	e2	51	59	83	85	93	96	87	106	114	105	124	132	160	163	171	173	160	
1,1	SLU	1133	917	754	626	527	449	387	337	297	263	234	210	190	172	157	144	132	
	SLE	863	606	441	332	255	201	161	131	108	90	76	64	55	48	41	36	32	
	e1	66	74	83	95	102	107	116	124	133	146	153	157	165	182	190	193	204	
	e2	51	58	65	91	93	84	90	97	109	140	137	123	129	181	183	164	186	
1,2	SLU	1270	1023	835	693	582	496	428	372	327	290	259	232	210	190	173	158	145	
	SLE	959	673	491	369	284	223	179	145	120	100	84	72	61	53	46	40	36	
	e1	71	79	88	94	107	115	124	131	139	150	159	167	168	177	188	206	211	
	e2	68	74	80	75	105	111	116	117	123	142	148	154	124	135	151	204	196	
1,25	SLU	1337	1074	876	725	610	519	448	390	343	304	271	243	219	199	181	166	152	
	SLE	1008	708	516	388	299	235	188	153	126	105	88	75	64	56	48	42	37	
	e1	72	78	89	99	102	115	125	128	141	151	158	168	178	190	198	204	210	
	e2	69	65	80	94	75	105	114	95	125	139	135	150	164	188	189	184	180	
1,5	SLU	1675	1332	1080	892	750	639	551	480	422	374	333	299	270	245	223	204	187	
	SLE	1260	885	645	485	373	294	235	191	158	131	111	94	81	70	61	53	47	
	e1	72	84	96	105	108	118	134	142	144	154	167	183	191	190	209	213	220	
	e2	53	75	92	99	80	93	127	131	107	119	141	180	183	146	195	180	179	
LEGENDA / INDEX																			
Valori carico ammissibile uniformemente distribuito <i>Distributed load and resistance factor design</i>	>	Per la condizione di Stato Limite Ultimo (SLU) della lamiera / <i>Ultimate limit-state design of the corrugated sheet (SLU)</i>																	
	>	Per la condizione di Stato Limite di Esercizio (SLE) della lamiera ($F \leq L/400$) / <i>Serviceability limit of the corrugated sheet (SLE) ($F \leq L/400$)</i>																	

I rapporti di prova pubblicati in questo catalogo vengono forniti a titolo puramente indicativo. I dati pubblicati sono stati calcolati secondo le Norme vigenti: NTC2018, Circolare esplicativa alle NTC2018, UNI EN 1993 (EC3). Per una corretta applicazione del prodotto sarà onere e cura del cliente e/o del progettista la redazione di calcoli appropriati con specifico riferimento al singolo impiego.

The test reports published in this catalogue are provided for indicative purposes only. The published data have been calculated according to the current regulations: NTC2018, Explanatory circular to NTC2018, UNI EN 1993 (EC3). For a correct application of the product, it will be responsibility and care of the customer and/or the designer to draw up appropriate calculations with specific reference to the individual use.

TABELLA (10) DI PORTATA AMPEX: ACCIAIO S 250 GD / LOAD TABLE AMPEX: STEEL S 250 GD

I valori di portata in tabella non includono il peso proprio della lamiera grecata.
The capacity load shown in the table does not include the weight of the metal sheet itself.

TABELLA DI PORTATA AMPEX: ACCIAIO S 250 GD / LOAD TABLE AMPEX: STEEL S 250 GD		PORTATA DEL PROFILO CON FRECCIA $\leq L/200$ / SHEET CAPACITY WITH DEFLECTION $\leq L/200$ OF A SPAN																	
Spessore / thickness	Carico Limite Limit Design Deflection																		
		CARICHI MASSIMI [kg/m ²] E LUNGHEZZE IDEALI DEGLI SBALZI PER TRAVE GERBER (e1; e2; e3) [cm]																	
mm	kg/m ²	4	4,5	5	5,5	6	6,5	7	7,5	8	8,5	9	9,5	10	10,5	11	11,5	12	
0,8	SLU	727	595	498	417	357	308	264	232	205	180	161	145	130	119	108	99	91	
	SLE	727	595	498	417	341	269	215	175	144	120	101	86	74	64	55	49	43	
	e1	59	67	75	82	89	97	103	112	119	126	135	141	149	154	164	172	178	
	e2	54	66	73	78	85	97	91	109	115	121	133	134	145	140	158	169	170	
	e3	51	58	64	71	77	83	90	96	102	109	115	121	128	134	141	147	153	
0,9	SLU	856	698	584	489	412	354	305	265	235	207	185	167	150	136	124	113	104	
	SLE	856	698	584	489	397	313	250	203	168	140	118	100	86	74	64	56	50	
	e1	62	70	77	87	95	101	108	116	126	130	143	147	153	161	174	182	190	
	e2	55	65	64	84	94	93	91	101	122	109	141	129	127	137	169	178	188	
	e3	54	61	67	74	81	87	94	101	107	114	121	127	134	141	147	154	161	
1,0	SLU	995	810	667	558	469	401	346	301	265	235	209	188	169	154	140	128	118	
	SLE	995	810	667	558	454	357	286	233	192	160	135	114	98	85	74	65	57	
	e1	64	72	84	91	99	106	112	122	130	135	146	154	166	173	182	189	193	
	e2	51	59	83	85	93	96	87	106	114	105	124	132	160	163	171	173	160	
	e3	56	63	70	77	84	91	98	105	112	119	126	133	140	147	154	161	168	
1,1	SLU	1126	914	752	618	522	446	386	337	296	261	233	210	189	172	156	143	131	
	SLE	1126	914	752	618	511	402	322	262	216	180	151	129	110	95	83	73	64	
	e1	66	74	83	95	102	107	116	124	133	146	153	157	165	182	190	193	204	
	e2	51	58	65	91	93	84	90	97	109	140	137	123	129	181	183	164	186	
	e3	58	65	72	80	87	94	101	108	115	123	130	137	144	151	159	166	173	
1,2	SLU	1267	1012	830	692	577	494	427	370	326	288	257	232	208	189	173	158	145	
	SLE	1267	1012	830	692	568	447	358	291	240	200	168	143	123	106	92	81	71	
	e1	71	79	88	94	107	115	124	131	139	150	159	167	168	177	188	206	211	
	e2	68	74	80	75	105	111	116	117	123	142	148	154	124	135	151	204	196	
	e3	59	67	74	81	89	96	103	111	118	126	133	140	148	155	162	170	177	
1,25	SLU	1329	1074	869	724	605	518	444	389	343	302	271	242	219	198	181	165	152	
	SLE	1329	1074	869	724	597	470	376	306	252	210	177	150	129	111	97	85	75	
	e1	72	78	89	99	102	115	125	128	141	151	158	168	178	190	198	204	210	
	e2	69	65	80	94	75	105	114	95	125	139	135	150	164	188	189	184	180	
	e3	60	67	75	82	90	97	105	112	119	127	134	142	149	157	164	172	179	
1,5	SLU	1661	1317	1080	890	747	635	547	480	421	373	332	298	270	245	223	203	187	
	SLE	1661	1317	1080	890	747	587	470	382	315	263	221	188	161	139	121	106	93	
	e1	72	84	96	105	108	118	134	142	144	154	167	183	191	190	209	213	220	
	e2	53	75	92	99	80	93	127	131	107	119	141	180	183	146	195	180	179	
	e3	63	71	78	86	94	102	110	117	125	133	141	149	156	164	172	180	188	

LEGGENDA / INDEX

Valori carico ammissibile uniformemente distribuito <i>Distributed load and resistance factor design</i>	>	Per la condizione di Stato Limite Ultimo (SLU) della lamiera / <i>Ultimate limit-state design of the corrugated sheet (SLU)</i>
	>	Per la condizione di Stato Limite di Esercizio (SLE) della lamiera ($F \leq L/200$) / <i>Serviceability limit of the corrugated sheet (SLE) ($F \leq L/200$)</i>

I rapporti di prova pubblicati in questo catalogo vengono forniti a titolo puramente indicativo. I dati pubblicati sono stati calcolati secondo le Norme vigenti: NTC2018, Circolare esplicativa alle NTC2018, UNI EN 1993 (EC3). Per una corretta applicazione del prodotto sarà onere e cura del cliente e/o del progettista la redazione di calcoli appropriati con specifico riferimento al singolo impiego.

The test reports published in this catalogue are provided for indicative purposes only. The published data have been calculated according to the current regulations: NTC2018, Explanatory circular to NTC2018, UNI EN 1993 (EC3). For a correct application of the product, it will be responsibility and care of the customer and/or the designer to draw up appropriate calculations with specific reference to the individual use.

TABELLA (10) DI PORTATA AMPEX: ACCIAIO S 250 GD / LOAD TABLE AMPEX: STEEL S 250 GD

I valori di portata in tabella non includono il peso proprio della lamiera grecata.
The capacity load shown in the table does not include the weight of the metal sheet itself.

TABELLA DI PORTATA AMPEX: ACCIAIO S 250 GD / LOAD TABLE AMPEX: STEEL S 250 GD		PORTATA DEL PROFILO CON FRECCIA $\leq L/400$ / SHEET CAPACITY WITH DEFLECTION $\leq L/400$ OF A SPAN																	
Spessore / thickness	Carico Limite Limit Design Deflection																		
		CARICHI MASSIMI [kg/m ²] E LUNGHEZZE IDEALI DEGLI SBALZI PER TRAVE GERBER (e1; e2; e3) [cm]																	
mm	kg/m ²	4	4,5	5	5,5	6	6,5	7	7,5	8	8,5	9	9,5	10	10,5	11	11,5	12	
0,8	SLU	727	595	498	417	357	308	264	232	205	180	161	145	130	119	108	99	91	
	SLE	576	405	295	222	171	134	108	87	72	60	51	43	37	32	28	24	21	
	e1	59	67	75	82	89	97	103	112	119	126	135	141	149	154	164	172	178	
	e2	54	66	73	78	85	97	91	109	115	121	133	134	145	140	158	169	170	
	e3	51	58	64	71	77	83	90	96	102	109	115	121	128	134	141	147	153	
0,9	SLU	856	698	584	489	412	354	305	265	235	207	185	167	150	136	124	113	104	
	SLE	671	471	343	258	199	156	125	102	84	70	59	50	43	37	32	28	25	
	e1	62	70	77	87	95	101	108	116	126	130	143	147	153	161	174	182	190	
	e2	55	65	64	84	94	93	91	101	122	109	141	129	127	137	169	178	188	
	e3	54	61	67	74	81	87	94	101	107	114	121	127	134	141	147	154	161	
1,0	SLU	995	810	667	558	469	401	346	301	265	235	209	188	169	154	140	128	118	
	SLE	767	539	392	295	227	179	143	116	96	80	67	57	49	42	37	32	28	
	e1	64	72	84	91	99	106	112	122	130	135	146	154	166	173	182	189	193	
	e2	51	59	83	85	93	96	87	106	114	105	124	132	160	163	171	173	160	
	e3	56	63	70	77	84	91	98	105	112	119	126	133	140	147	154	161	168	
1,1	SLU	1126	914	752	618	522	446	386	337	296	261	233	210	189	172	156	143	131	
	SLE	863	606	441	332	255	201	161	131	108	90	76	64	55	48	41	36	32	
	e1	66	74	83	95	102	107	116	124	133	146	153	157	165	182	190	193	204	
	e2	51	58	65	91	93	84	90	97	109	140	137	123	129	181	183	164	186	
	e3	58	65	72	80	87	94	101	108	115	123	130	137	144	151	159	166	173	
1,2	SLU	1267	1012	830	692	577	494	427	370	326	288	257	232	208	189	173	158	145	
	SLE	959	673	491	369	284	223	179	145	120	100	84	72	61	53	46	40	36	
	e1	71	79	88	94	107	115	124	131	139	150	159	167	168	177	188	206	211	
	e2	68	74	80	75	105	111	116	117	123	142	148	154	124	135	151	204	196	
	e3	59	67	74	81	89	96	103	111	118	126	133	140	148	155	162	170	177	
1,25	SLU	1329	1074	869	724	605	518	444	389	343	302	271	242	219	198	181	165	152	
	SLE	1008	708	516	388	299	235	188	153	126	105	88	75	64	56	48	42	37	
	e1	72	78	89	99	102	115	125	128	141	151	158	168	178	190	198	204	210	
	e2	69	65	80	94	75	105	114	95	125	139	135	150	164	188	189	184	180	
	e3	60	67	75	82	90	97	105	112	119	127	134	142	149	157	164	172	179	
1,5	SLU	1661	1317	1080	890	747	635	547	480	421	373	332	298	270	245	223	203	187	
	SLE	1260	885	645	485	373	294	235	191	158	131	111	94	81	70	61	53	47	
	e1	72	84	96	105	108	118	134	142	144	154	167	183	191	190	209	213	220	
	e2	53	75	92	99	80	93	127	131	107	119	141	180	183	146	195	180	179	
	e3	63	71	78	86	94	102	110	117	125	133	141	149	156	164	172	180	188	

LEGENDA / INDEX		
Valori carico ammissibile uniformemente distribuito <i>Distributed load and resistance factor design</i>	>	Per la condizione di Stato Limite Ultimo (SLU) della lamiera / <i>Ultimate limit-state design of the corrugated sheet (SLU)</i>
	>	Per la condizione di Stato Limite di Esercizio (SLE) della lamiera ($F \leq L/400$) / <i>Serviceability limit of the corrugated sheet (SLE) ($F \leq L/400$)</i>

I rapporti di prova pubblicati in questo catalogo vengono forniti a titolo puramente indicativo. I dati pubblicati sono stati calcolati secondo le Norme vigenti: NTC2018, Circolare esplicativa alle NTC2018, UNI EN 1993 (EC3). Per una corretta applicazione del prodotto sarà onere e cura del cliente e/o del progettista la redazione di calcoli appropriati con specifico riferimento al singolo impiego.

The test reports published in this catalogue are provided for indicative purposes only. The published data have been calculated according to the current regulations: NTC2018, Explanatory circular to NTC2018, UNI EN 1993 (EC3). For a correct application of the product, it will be responsibility and care of the customer and/or the designer to draw up appropriate calculations with specific reference to the individual use.

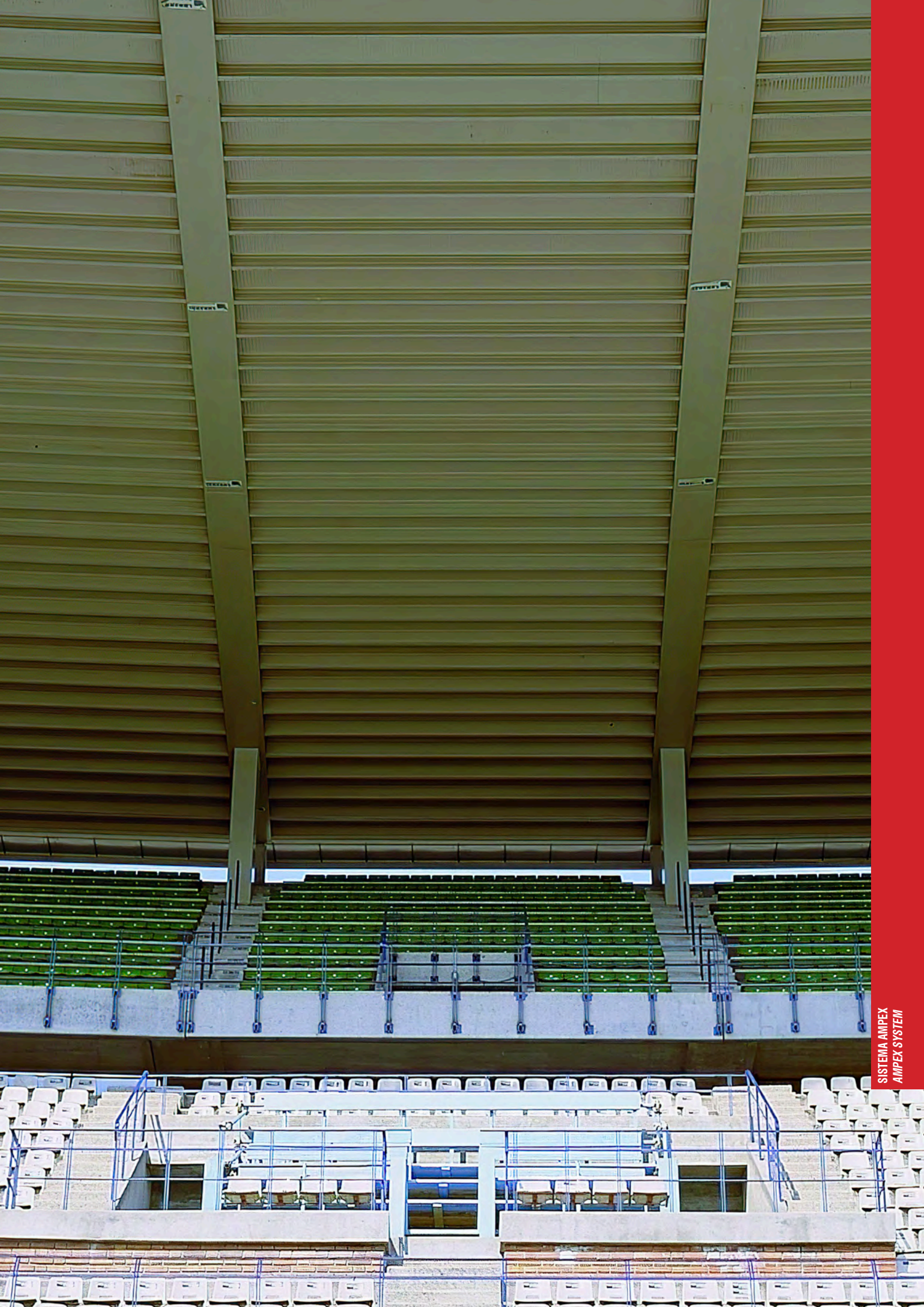

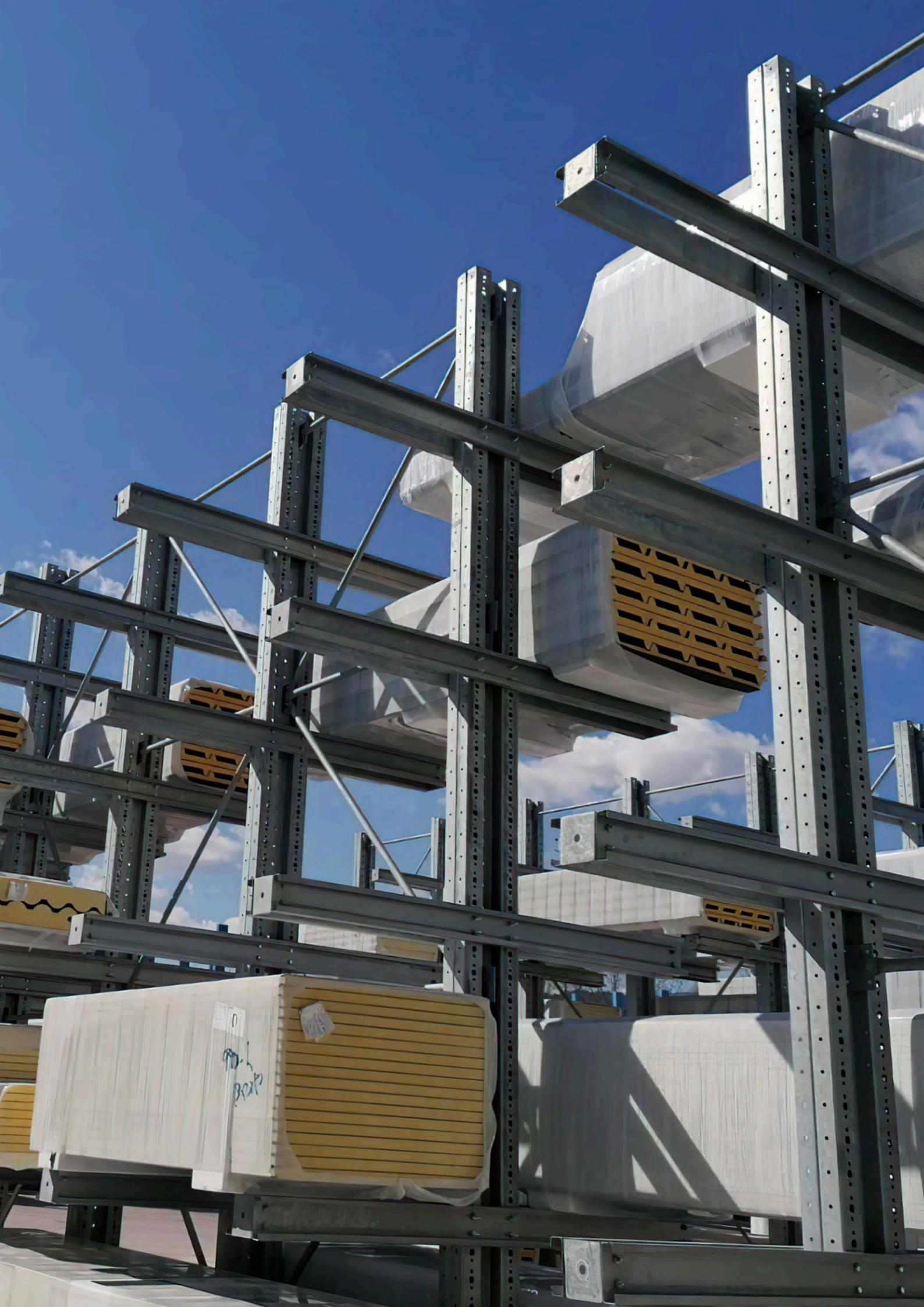

Le scaffalature **Cantilever Isostock**, grazie alla mancanza di montanti anteriori, sono configurate per lo stoccaggio a diverse altezze, anche elevate, di merci lunghe e ingombranti (profilati metallici, tubi, listelli, pannelli di legno, lastre metalliche o di plastica, ecc.). Sono strutture costituite da un supporto di profili verticali (colonne) e orizzontali (basi), e da bracci a sbalzo sui quali viene depositato il carico.

Le scaffalature **Cantilever Isostock** possono essere monofronti (generalmente a filoparete, con accesso da un solo lato) o bifronti (con accesso dai due lati), per soddisfare le diverse configurazioni del magazzino, e sono compatibili con tutti i sistemi di movimentazione merci, come gru di impilaggio e carrelli elevatori a forche laterali o frontali.

Si possono inoltre utilizzare per la costruzione di magazzini destinati alla logistica, quando occorre sfruttare al massimo la superficie e il volume disponibili.

I calcoli, le prove e i collaudi effettuati sulle scaffalature **Cantilever Isostock** sono garanzia di sicurezza per gli impianti, per le merci da stoccare e, soprattutto, per chi opera nei magazzini.

The **Cantilever Isostock** racking, thanks to the lack of front uprights, are configured for the storage at different heights, even at great height, of long and bulky goods (metal profiles, pipes, strips, wooden panels, metal or plastic plates, etc.). These structures consist of a support of vertical profiles (columns) and horizontal (bases), and of cantilevered arms on which the load is deposited.

The **Cantilever Isostock** racking can be single-sided (generally flush-to-wall, with access from one side only) or double-sided (with access from both sides), to satisfy the different warehouse configurations, and are compatible with all goods handling systems, such as stacking cranes and side or front forklifts.

The racking can also be used for the construction of warehouses for logistics, when it is necessary to make the most of the available surface and volume.

The calculations, tests and inspections carried out on the **Cantilever Isostock** racking are a guarantee of safety for the systems, for the goods to be stored and, above all, for those who work in the warehouses.

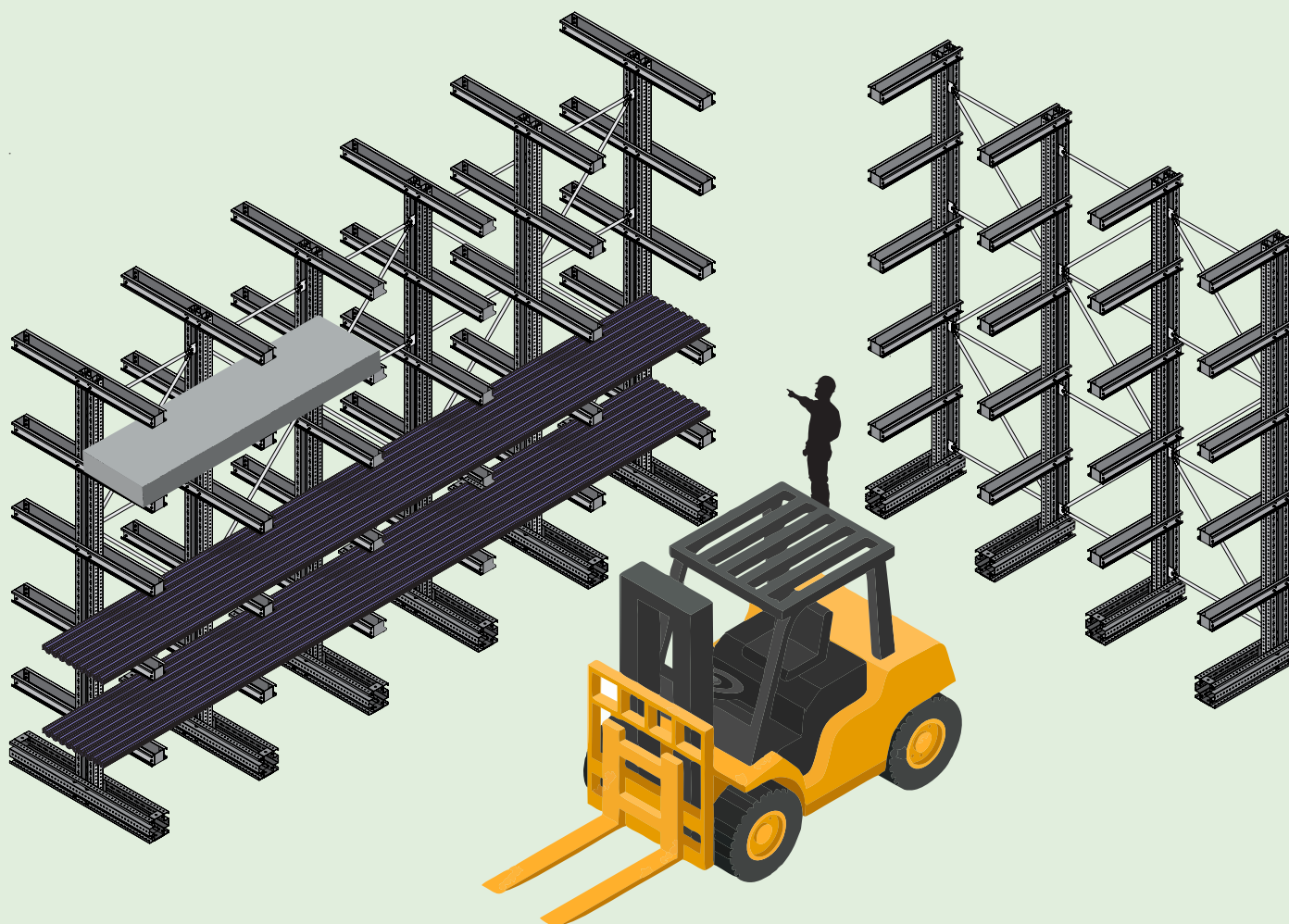

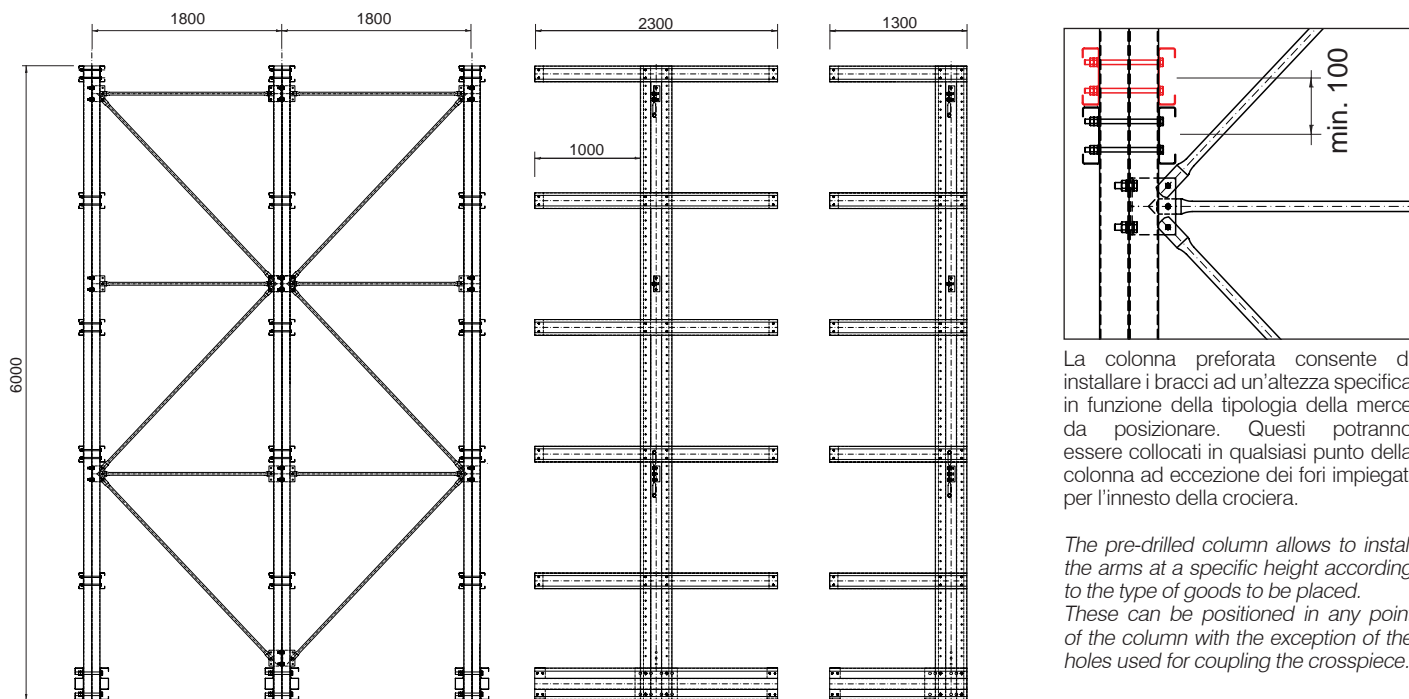

La colonna preforata consente di installare i bracci ad un'altezza specifica in funzione della tipologia della merce da posizionare. Questi potranno essere collocati in qualsiasi punto della colonna ad eccezione dei fori impiegati per l'innesco della crociera.

The pre-drilled column allows to install the arms at a specific height according to the type of goods to be placed. These can be positioned in any point of the column with the exception of the holes used for coupling the crosspiece.

Ai fini della stabilità e della sicurezza, è fatto obbligo di ancorare a terra l'intera struttura. La classe di resistenza del pavimento in cemento armato si ipotizza non inferiore a C25/30. Nel caso di pavimenti aventi resistenza inferiore è necessaria una verifica da parte del nostro ufficio tecnico. Sarà onere e cura del cliente e/o del progettista la redazione di calcoli appropriati degli ancoraggi con specifico riferimento al singolo impiego (quantità, profondità e tipologia di tassello).

For stability and safety purposes, the entire structure must be anchored to the ground. The strength class of the reinforced concrete floor is assumed to be not lower than C25/30. In the case of floors with lower resistance, a check by our technical office is required. It is responsibility of the customer and/or the designer to prepare appropriate calculations of the anchors with specific reference to the individual use (quantity, depth and type of anchor).

Caratteristiche tecniche - Datasheet

Altezza colonna: 6000 (mm) altezza standard, tuttavia è possibile fabbricare colonne di altre misure in base alle esigenze del cliente.

Interasse modulo: 1800 (mm)

Tipologia: le mensole possono essere monofronte o bifronte a seconda che realizzino lo sbalzo su uno o due fronti della scaffalatura

Larghezza base versione bifronte:

2300 (mm) - 2 x mensola 1000 (mm)

Larghezza base versione monofronte:

1300 (mm) - 1 x mensola 1000 (mm)

Acciaio certificato:

S 235 (UNI EN 10025 - UNI EN 10210)

Bulloni: Classe 8.8 zincati

Trattamenti protettivi applicabili a richiesta: (valido per tutte le esposizioni) zincatura a caldo secondo UNI EN 1461, (solo per interni) verniciatura a polvere epossidica, vernici bicomponenti poliuretaniche.

Accessori: il sistema è compatibile con tutti gli accessori previsti per il Cantilever tradizionale, tra cui i supporti reggibobina, reggitubo e i fermacarico.

Column height: 6000 (mm) standard height, however it is possible to manufacture columns of other sizes according to the customer's needs.

Module spacing: 1800 (mm)

Typology: the shelves can be single-sided or double-sided depending on whether they carry out the cantilever on one or two sides of the racking.

Double-faced version base width:

2300 (mm) - 2 x shelf 1000 (mm)

Single-sided version base width:

1300 (mm) - 1 x shelf 1000 (mm)

Certified steel:

S 235; S 250 (UNI EN 10025 - UNI EN 10210)

Bolts: Classe 8.8 zincati

Protective treatments applicable on request:

(valid for all environmental situations) hot galvanizing according to UNI EN 1461, (for interiors only) epoxy powder coating, bi-component polyurethane paints.

Accessories: the system is compatible with all the accessories provided for the traditional cantilever, including the reel holder supports, pipe holder and load stops.

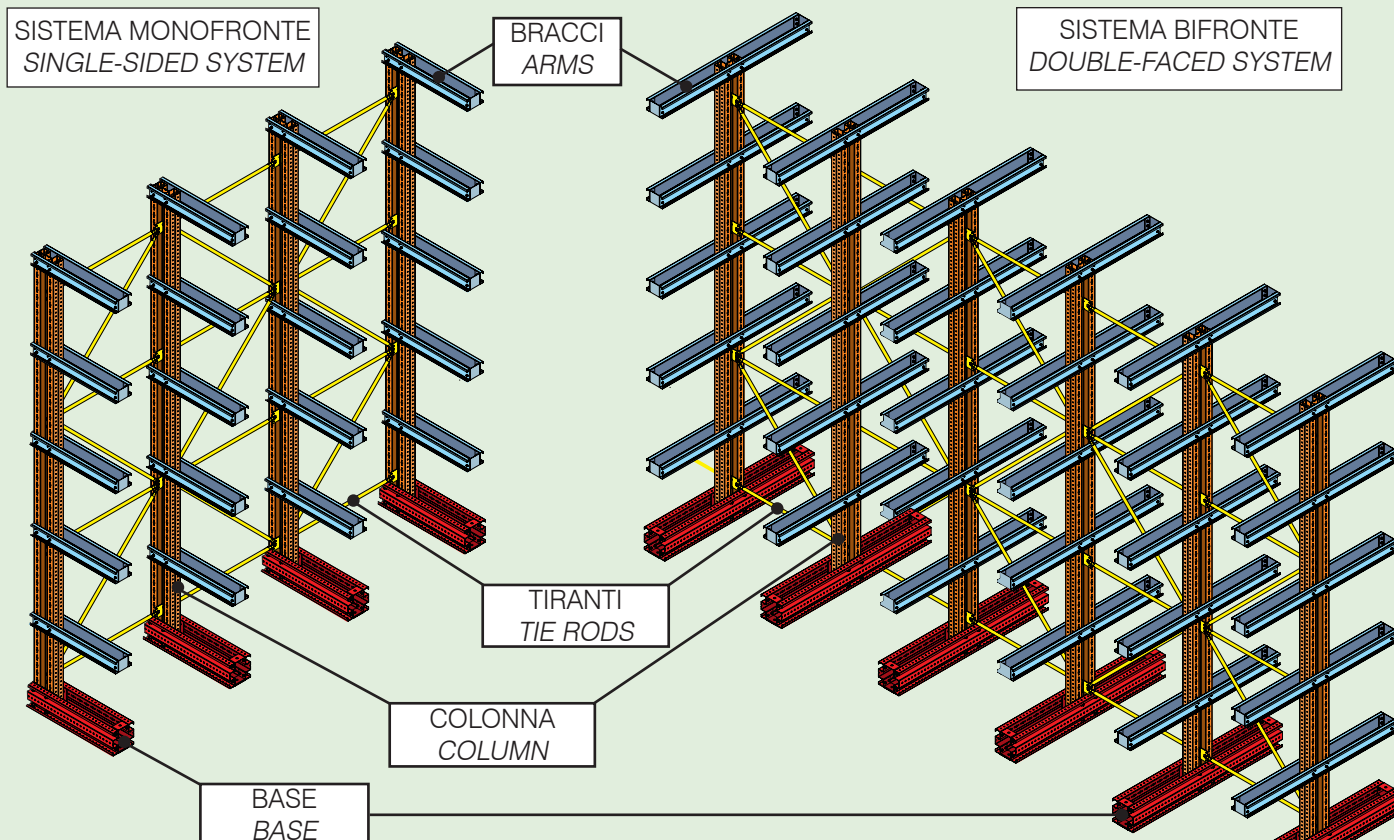

Le differenziazione delle componenti per colori qui riportata, ha il solo scopo di facilitare l'interpretazione del disegno.
 The breakdown by color of the components shown here is for the sole purpose of facilitating the interpretation of the drawing.

BASE (colore rosso)

La base di **Isostock Cantilever** è l'elemento fondamentale sul quale si scaricano le forze verticali dell'intero sistema (il peso proprio più i carichi dello stoccaggio), e viene realizzata dall'accoppiamento di due profili LEVER imbullonati alla colonna. Rappresenta certamente l'elemento più importante ai fini della sicurezza.

Base e colonna sono tenuti insieme imbullonandoli mediante una piastra di fissaggio che permette un corretto accostamento e un facile livellamento. Potendo venire involontariamente urtata da attrezzature in movimento, come le forche dei muletti di carico, dalla base sono state eliminate sporgenze derivanti da piastre e bulloni, collocando gli elementi in appositi alloggiamenti interni al profilo, al fine di evitare agganci pericolosi che potrebbero compromettere la sicurezza degli operatori e dell'intero sistema.

COLONNA (colore arancio)

La colonna è l'elemento verticale per il sostegno delle mensole e viene realizzata mediante accoppiamento di due profili LEVER laminati a caldo, il cui spessore varia in funzione del carico che devono sopportare. La versione monofronte (con le mensole su un solo lato della colonna) presenta una maggiore entità della freccia (flessione) sulla colonna rispetto a quella bifronte.

BRACCI (colore azzurro)

I bracci a sbalzo, anche detti mensola, sono gli elementi sporgenti della struttura su cui viene depositato il carico. Si tratta di profili laminati la cui geometria e le cui dimensioni variano in funzione del carico da sopportare. Sono formati da due profili a C imbullonati alla colonna e uniti fra loro mediante ulteriori C di raccordo.

Tutti i bracci sono dotati nell'estremità di entrata del carico di un elemento curvo che facilita il deposito della merce. Inoltre, vengono sempre posizionati con una leggera inclinazione per evitare la possibile caduta del carico.

TIRANTI (colore giallo)

Le colonne e tutti gli altri elementi del sistema sono tenuti insieme da apposite crociere o tiranti, che svolgono una funzione importantissima per la stabilità dell'intera struttura. La crociera d'irrigidimento, fissata alla colonna tramite bulloni, assicura stabilità longitudinale della scaffalatura.

BASE (red colour)

The base of the **Isostock Cantilever** is the fundamental element on which the vertical forces of the entire system are discharged (the weight plus the storage loads), and is created by coupling two LEVER profiles bolted to the column. It certainly represents the most important element for safety purposes.

Base and column are bolted together by means of a fixing plate that allows a correct combination and easy leveling. Since it can be accidentally bumped by moving equipment, such as loading forklifts, ledges deriving from plates and bolts have been eliminated from the base, placing the elements in special housings inside the profile, in order to avoid dangerous hooks that could compromise the safety of the operators and the entire system.

COLUMN (orange colour)

The column is the vertical element for supporting the shelves and is made by coupling two hot-rolled LEVER profiles, whose thickness varies according to the load they have to support. The single-sided version (with the shelves on one side of the column) has a greater extent of the arrow (bending) on the column than the double-sided one.

ARMS (light blue colour)

The cantilevered arms, also called shelves, are the protruding elements of the structure on which the load is deposited. These are rolled profiles whose geometry and dimensions vary according to the load to be supported. They consist of two C-profiles bolted to the column and joined together by means of further C connection. All arms are equipped at the entry end of the load with a curved element that facilitates the storage of goods. In addition, they are always positioned with a slight inclination to avoid the possible fall of the load.

TIE RODS (yellow colour)

The columns and all the other elements of the system are held together by special crosses or tie rods, which perform a very important function for the stability of the entire structure. The stiffening cross, fixed to the column by bolts, ensures longitudinal stability of the racking.

ALCUNE CONFIGURAZIONI POSSIBILI - SOME POSSIBLE CONFIGURATIONS

Le differenziazione delle componenti per colori qui riportata, ha il solo scopo di facilitare l'interpretazione del disegno.
 The breakdown by color of the components shown here is for the sole purpose of facilitating the interpretation of the drawing.

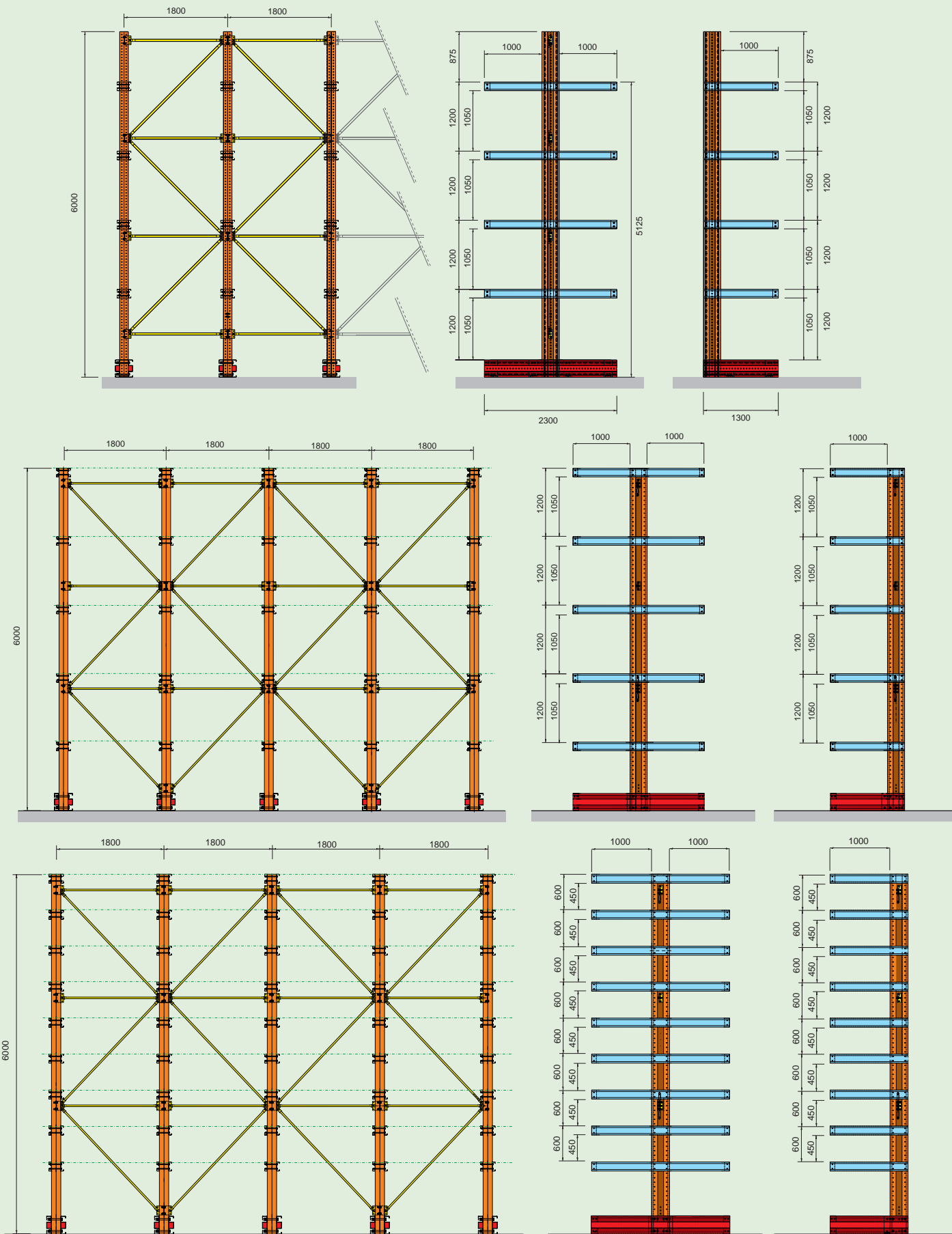

Qui vediamo alcune tra le infinite possibilità di configurazione realizzabili con **Isostock Cantilever**.

La massima versatilità, la facilità di configurazione e la possibilità di imbullonare le mensole ad altezze variabili rendono il sistema Isostock adatto a tutte le esigenze di magazzino, in funzione delle differenti altezze e tipologie di merci.

Here we see some of the infinite possible configuration that can be created with **Isostock Cantilever**.

The maximum versatility, the ease of configuration and the possibility of bolting the shelves at variable heights makes the Isostock system suitable for all warehouse needs, according to the different heights and types of goods.



TABELLE DI PORTATA - LOAD TABLES

CARICO LINEARMENTE DISTRIBUITO LINEARLY DISTRIBUTED LOAD



Tabelle (in basso) fondo azzurro
Tables (below) light blue background

CARICO SU CIASCUNA MENSOLA LOAD ON EACH SHELF

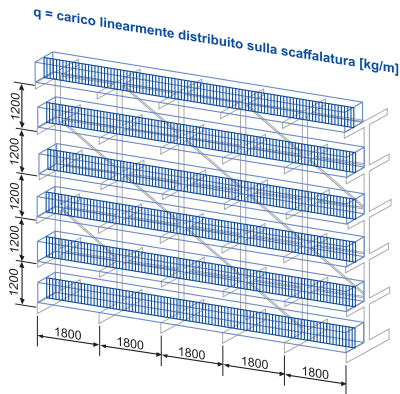

Tabelle (in basso) fondo verde chiaro
Tables (bottom) light green background

CARICO COMPLESSIVO SUL MODULO TOTAL LOAD ON THE MODULE

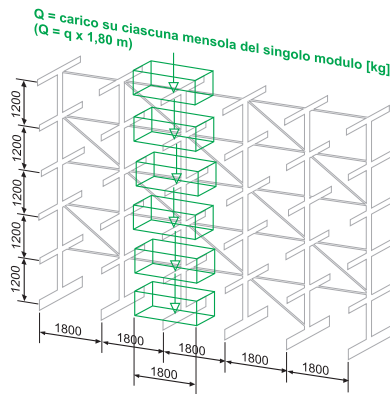

Tabelle (in basso) fondo rosa
Tables (bottom) pink background

SCAFFALATURA MONOFRONTA SINGLE-SIDED RACKING	ZONA SISMICA/SEISMIC AREA (O.P.C.M. n.3274)											
	classe/class 4 [0,05g]			classe/class 3 [0,15g]			classe/class 2 [0,25g]			classe/class 1 [0,35g]		
Spessore profilo montante piede [mm] Foot upright profile thickness [mm]	q [kg/m]	Q [kg]	P [kg]	q [kg/m]	Q [kg]	P [kg]	q [kg/m]	Q [kg]	P [kg]	q [kg/m]	Q [kg]	P [kg]
3.0	180	320	1620	100	180	900	70	125	630	50	90	450
2.5	160	285	1440	95	170	855	65	115	585	50	90	450
2.0	130	230	1170	80	140	720	55	95	495	40	70	360
1.5	70	125	630	45	80	405	30	50	270	25	45	225

N.B. CARICHI PER OGNI FRONTE / LOADS FOR EACH FRONT

SCAFFALATURA BIFRONTA DOUBLE-SIDED RACKING	ZONA SISMICA/SEISMIC AREA (O.P.C.M. n.3274)											
	classe/class 4 [0,05g]			classe/class 3 [0,15g]			classe/class 2 [0,25g]			classe/class 1 [0,35g]		
Spessore profilo montante piede [mm] Foot upright profile thickness [mm]	q [kg/m]	Q [kg]	P [kg]	q [kg/m]	Q [kg]	P [kg]	q [kg/m]	Q [kg]	P [kg]	q [kg/m]	Q [kg]	P [kg]
3.0	140	250	1260	75	135	675	45	80	405	35	60	315
2.5	120	215	1080	65	115	585	40	70	360	30	50	270
2.0	100	180	900	50	90	450	35	60	315	25	45	225
1.5	50	90	450	30	50	270	20	35	180	15	25	135

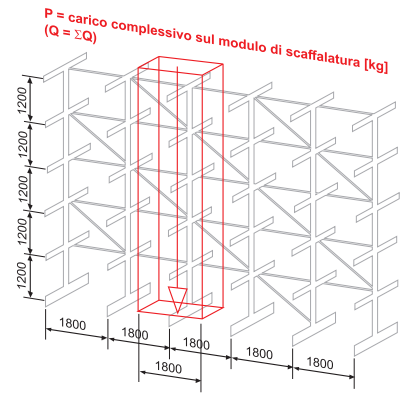
q = carico linearmente distribuito sulla scaffalatura ad ogni livello (con livelli distanti 1.2 m tra loro)
load linearly distributed on the shelving at each level (with levels 1.2 m apart)

Q = carico sulla mensola di ogni modulo per ogni livello (con livelli distanti 1.2 m tra loro)
load on the shelf of each module for each level (with levels 1.2 m apart)

P = carico complessivo sul modulo di scaffalatura (distribuito sui vari livelli di mensola)
total load on the shelving module (distributed on the various shelf levels)

Sarà onere e cura del cliente e/o del progettista la redazione di calcoli appropriati degli ancoraggi con specifico riferimento al singolo impiego (quantità, profondità e tipologia di tassello).
It is responsibility of the customer and/or the designer to prepare appropriate calculations of the anchors with specific reference to the individual use (quantity, depth and type of anchor).

L'analisi della struttura in oggetto è stata effettuata utilizzando i metodi usuali della Scienza delle Costruzioni ed in conformità alle normative e leggi vigenti, ed in particolare a:

The analysis of the structure was carried out using the usual methods of Construction Science and in compliance with the regulations and laws in force, and in particular with:

- D.M. 14/01/2008 – Norme tecniche per le costruzioni (nel seguito denominate NTC) e Circ. n. 617 del 02/02/2009 – Istruzioni per l'applicazione delle "Nuove Norme Tecniche per le Costruzioni" di cui al D.M. 14/01/2008.
- UNI EN 1992-1-1 Eurocodice 2 - Parte 1-1: Regole generali e regole per gli edifici.
- UNI EN 1993-1-3 Eurocodice 3 - Progettazione delle strutture di acciaio - Parte 1-3: Regole generali - Regole supplementari per l'impiego dei profilati e delle lamiere sottili piegati a freddo.
- UNI EN 1993-1-5 Eurocodice 3 - Progettazione delle strutture di acciaio - Parte 1-5: Elementi strutturali a lastra.

- D.M. 14/01/2008 – Technical standards for constructions (hereinafter referred to as NTC) and Circular n. 617 of 02/02/2009 - Instructions for the application of the "New Technical Standards for Construction" referred to D.M. 14/01/2008.
- UNI EN 1992-1-1 Eurocode 2 - Part 1-1: General rules and rules for buildings.
- UNI EN 1993-1-3 Eurocode 3 - Design of steel structures - Part 1-3: General rules - Additional rules for the use of cold bent profiles and thin sheets.
- UNI EN 1993-1-5 Eurocode 3 - Design of steel structures - Part 1-5: Structural sheet elements.





ISOLPACK®

